



Simply Better Connections

VM0404HB / VM0808HB

4 x 4 / 8 x 8 4K HDMI Matrix Switch
User Manual

Compliance Statements

FEDERAL COMMUNICATIONS COMMISSION INTERFERENCE STATEMENT

This equipment has been tested and found to comply with the limits for a Class A digital device, pursuant to Part 15 of the FCC Rules. These limits are designed to provide reasonable protection against harmful interference when the equipment is operated in a commercial environment. This equipment generates, uses, and can radiate radio frequency energy and, if not installed and used in accordance with the instruction manual, may cause harmful interference to radio communications. Operation of this equipment in a residential area is likely to cause harmful interference in which case the user will be required to correct the interference at his own expense.

The device complies with Part 15 of the FCC Rules. Operation is subject to the following two conditions: (1) this device may not cause harmful interference, and (2) this device must accept any interference received, including interference that may cause undesired operation.

FCC Caution

Any changes or modifications not expressly approved by the party responsible for compliance could void the user's authority to operate this equipment.

Warning

Operation of this equipment in a residential environment could cause radio interference.

Achtung

Der Gebrauch dieses Geräts in Wohnumgebung kann Funkstörungen verursachen.



KCC Statement

유선 제품용 / A 급 기기 (업무용 방송 통신 기기)
 이 기기는 업무용 (A 급) 전자파적합기기로서 판매자 또는 사용자는 이
 점을 주의하시기 바라며, 가정 외의 지역에서 사용하는 것을 목적으로
 합니다.

Industry Canada Statement

This Class A digital apparatus complies with Canadian ICES-003.

CAN ICES-003 (A) / NMB-003 (A)

HDMI Trademark Statement

The terms HDMI, HDMI High-Definition Multimedia Interface, and the HDMI Logo are trademarks or registered trademarks of HDMI Licensing Administrator, Inc.



RoHS

This product is RoHS compliant.

User Information

Online Registration

Be sure to register your product at our online support center:

International	http://eservice.aten.com
---------------	---

Telephone Support

For telephone support, call this number:

International	886-2-8692-6959
China	86-400-810-0-810
Japan	81-3-5615-5811
Korea	82-2-467-6789
North America	1-888-999-ATEN ext 4988 1-949-428-1111

User Notice

All information, documentation, and specifications contained in this manual are subject to change without prior notification by the manufacturer. The manufacturer makes no representations or warranties, either expressed or implied, with respect to the contents hereof and specifically disclaims any warranties as to merchantability or fitness for any particular purpose. Any of the manufacturer's software described in this manual is sold or licensed *as is*. Should the programs prove defective following their purchase, the buyer (and not the manufacturer, its distributor, or its dealer), assumes the entire cost of all necessary servicing, repair and any incidental or consequential damages resulting from any defect in the software.

The manufacturer of this system is not responsible for any radio and/or TV interference caused by unauthorized modifications to this device. It is the responsibility of the user to correct such interference.

The manufacturer is not responsible for any damage incurred in the operation of this system if the correct operational voltage setting was not selected prior to operation. PLEASE VERIFY THAT THE VOLTAGE SETTING IS CORRECT BEFORE USE.

Product Information

For information about all ATEN products and how they can help you connect without limits, visit ATEN on the Web or contact an ATEN Authorized Reseller. Visit ATEN on the Web for a list of locations and telephone numbers:

International	http://www.aten.com
North America	http://www.aten-usa.com

Package Contents

Check to make sure that all the components are in working order. If you encounter any problem, please contact your dealer.

The VM0404HB / VM0808HB package consists of:

- ◆ 1 VM0404HB 4 x 4 True 4K HDMI Matrix Switch or
1 VM0808HB 8 x 8 True 4K HDMI Matrix Switch
- ◆ 1 power cord
- ◆ 1 IR remote control
- ◆ 1 IR receiver
- ◆ 1 rack mount kit
- ◆ 1 user instructions

Contents

Compliance Statements	i
User Information	iv
Online Registration	iv
Telephone Support	iv
User Notice	v
Product Information	v
Package Contents	vi
Contents	vii
About this Manual	xi
Conventions	xii

1. Introduction

Overview	1
Features	2
Requirements	3
Source Devices	3
Display Devices	3
Cables	3
Browsers	4
Components	5
VM0404HB Front View	5
VM0404HB Rear View	6
VM0808HB Front View	7
VM0808HB Rear View	8
IR Remote Control	9

2. Hardware Setup

Rack Mounting	11
Grounding	12
Cable Connection	13
Installation Diagram	14

3. Front Panel Configuration

Overview	15
Front Panel Pushbuttons	15
Enter Password	16
Main Screen	17
Port Switching	17
Input Port Selection	17

Output Port Selection	19
LCD Menu Organization	21
Menu Pushbutton	21
IP Setting	22
IP Address / Subnet Mask	22
Gateway	22
Serial Port Setting	23
Baud Rate Setting	23
Operation Mode	24
EDID Mode	24
CEC	25
Output Status	26
Security Mode	27
Mode	27
Change Password	28
Save to a Profile	29
Play/Stop the Profile Schedule	30
Profile Pushbutton	31
IR Remote Control Operation	32
Change the Input source of an Output display	32
Power on/off individual Output displays	32
Power on/off all Output displays	33

4. Browser Operation

Overview	35
Logging In	35
Main Page	36
Menu Bar	36
Connection Table	37
Output Icon	38
Grid View	39
Profile List	40
Adding/Playing a Profile	40
Profile List Options	41
Importing/Exporting a Profile	42
Profile Scheduling	43
System Settings	45
General	46
Serial Settings	46
Device Info	46
Other	46
User Account	47
Add Account	48
Permission Level	49
Port Name	50

Network	51
EDID	152
EDID Mode	53
Customized Mode	54
EDID & CEA Description	55
Customized EDID Settings	56
CEA Settings	59
Video Data	60
Maintenance	62
HDCP	63
CEC	64

5. CLI Commands

Overview	65
Connecting to the Matrix Switch via Telnet	65
Connecting to the Matrix Switch via RS-232	66
Command Verification	67
Commands	67
Switch Port Command	67
EDID Command	69
Mute Command	71
CEC Command	72
Echo Command	73
Black Screen Command	74
Read Command	75
Reset Command	75
Baud Rate Command	76
Save/Load Profile Command	77
Power on Detection Command	78

Appendix

Safety Instructions	79
General	79
Rack Mounting	81
Specifications	82
Telnet Operation	83
Configuration Menu	83
1. H – Call up the command list for help	83
2. IP – Set network settings	83
3. LO – Load connections from profile	84
4. PW – Change password	84
5. RI – Read what input is connected to nn output	85
6. RO – Read what output is connected to nn input	85
7. SB – Set serial port baud rate	85

8. SS – Switch input to specified output	85
9. SV – Save the current connections into a profile	85
10. TI – Set timeout	85
11. VR – Software version information	85
Technical Support	86
International	86
North America	86
ATEN Standard Warranty Policy	87
Limited Hardware Warranty	87

About this Manual

This User Manual is provided to help you get the most from your VM0404HB / VM0808HB system. It covers all aspects of installation, configuration and operation. An overview of the information found in the manual is provided below.

Chapter 1, Introduction, introduces you to the VM0404HB / VM0808HB system. Its purpose, features and benefits are presented, and its front and back panel components are described.

Chapter 2, Hardware Setup, describes how to set up your VM0404HB / VM0808HB installation.

Chapter 3, Front Panel Configuration, explains the fundamental concepts involved in operating the VM0404HB / VM0808HB at the local site via the front panel LCD display using pushbuttons.

Chapter 4, Browser Operation, provides a complete description of the VM0404HB / VM0808HB's Browser Graphical User Interface (GUI), and how to use it to remotely configure and operate the VM0404HB / VM0808HB.

Chapter 5, CLI Commands, provides a complete list of the serial control protocol commands used when utilizing the RS-232 Serial Port so that an extra source device can be utilized in the installation.

Appendix, which provides specifications and other technical information regarding the VM0404HB / VM0808HB.

Note:

- ◆ Read this manual thoroughly and follow the installation and operation procedures carefully to prevent any damage to the unit or any connected devices.
 - ◆ The product may be updated, with features and functions added, improved or removed since the release of this manual. For an up-to-date user manual, visit <http://www.aten.com/global/en>
-

Conventions

This manual uses the following conventions:

- Monospaced Indicates text that you should key in.
- [] Indicates keys you should press. For example, [Enter] means to press the **Enter** key. If keys need to be chorded, they appear together in the same bracket with a plus sign between them: [Ctrl+Alt].
1. Numbered lists represent procedures with sequential steps.
- ◆ Bullet lists provide information, but do not involve sequential steps.
- > Indicates selecting the option (on a menu or dialog box, for example), that comes next. For example, Start > Run means to open the *Start* menu, and then select *Run*.
-  Indicates critical information.

Chapter 1

Introduction

Overview

The ATEN VM0404HB / VM0808HB is a True 4K HDMI Matrix Switch series that offers an easy and affordable way to route any of 4 / 8 HDMI video sources to any of 4 / 8 HDMI displays. Featured with the superior video resolutions up to 4096 x 2160@60Hz (4:4:4), the VM0404HB / VM0808HB delivers robust signal routing and ultra-fast digital video switching, making it ideal for applications where routing of True 4K digital signals is required, such as event venues, digital classrooms, auditoriums, department stores, and more.

You can easily configure the VM0404HB / VM0808HB via the front panel LCD display and pushbuttons, and through the use of an IR Remote Control. The LCD provides a quick view of all port connections, and lets operators access the unit's built-in configuration utility.

Furthermore, the VM0404HB / VM0808HB allows convenient configuration and operation via an intuitive Graphical User Interface (GUI) using any web browser. Because your VM0404HB / VM0808HB can be controlled over a standard TCP/IP connection, it conveniently integrates into any existing network for easy remote access. The VM0404HB / VM0808HB also supports a free app, the ATEN Video Matrix Control app, allowing you to switch profiles and audio-video inputs on the go. For more information, see *Video Matrix Control App User Manual*. For complete system and install integration, serial control is standard through the VM0404HB / VM0808HB's built-in RS-232 port that allows the switch to be controlled through a high-end controller or PC.

Features

- ◆ Connects up to 4 (VM0404HB) or 8 (VM0808HB) HDMI sources to any of 4/8 HDMI displays
- ◆ Supports True 4K resolutions up to 4096 x 2160 @ 60Hz (4:4:4)
- ◆ Supports HDR 10+
- ◆ Multiple Control Methods – system management via front-panel pushbuttons, IR remote, RS-232 control, and Web GUI / Telnet via Ethernet connections
- ◆ Supports free mobile control using the Video Matrix Control App*
- ◆ EDID Expert™ – selects optimum EDID settings for smooth power-up, high-quality display and use of the best video resolution across different screens
- ◆ Signaling rates up to 6 Gbits for flawless true 4K output
- ◆ Supports Dolby True HD and DTS HD Master audio
- ◆ HDMI (3D, Deep color, 4K); HDCP 2.2 compatible
- ◆ Consumer Electronics Control (CEC) allows interconnected HDMI devices to communicate and respond to a single remote control
- ◆ ESD protection for HDMI connections
- ◆ Supports ATEN's LockPro™ HDMI cable lock for secure HDMI cable connections
- ◆ Firmware upgradeable
- ◆ Rack mountable (1U design)

Note: For more information on the Video Matrix Control app, see *Video Matrix Control App User Manual*.

Requirements

The following devices are required for a complete VM0404HB / VM0808HB installation:

Source Devices

- ◆ Computer or A/V source device with HDMI Type A output connector(s)

Note: A DVI/HDMI adapter is required when connecting a DVI source device.

Display Devices

- ◆ Display devices or receivers with an HDMI Type A input connector

Cables

- ◆ 1 HDMI cable for each source device you will be connecting
- ◆ 1 HDMI cable for each display device you will be connecting
- ◆ 1 Cat 5e cable
- ◆ 1 RS-232 serial cable

Note: No cables are included in this package. We strongly recommend that you purchase high-quality cables of appropriate length since this will affect the quality of the audio and video display. Contact your dealer to purchase the correct cable sets.

Browsers

Supported web browsers are shown in the table below:

OS	Java Version	Browser	Version
Windows 2016	V1.8.0_161	IE	11
Windows 2012 R2	V1.8.0_161	IE	11
Windows 10	V1.8.0_161	edge	40.15063.0.0
		Firefox	58.0.2
		Chrome	64
		Opera	50
		QQ	10
		baidu	8.7.5000.4969
		360	9
Windows 8.1	V1.8.0_161	IE	11
Windows 7 SP1	V1.8.0_161	IE	11
CentOS 7.0	V1.8.0_161	Firefox	58.0.2
Ubuntu 16.04	V1.8.0_131	Chrome	64
Mac 10.9		Safari	10.9

Components

VM0404HB Front View

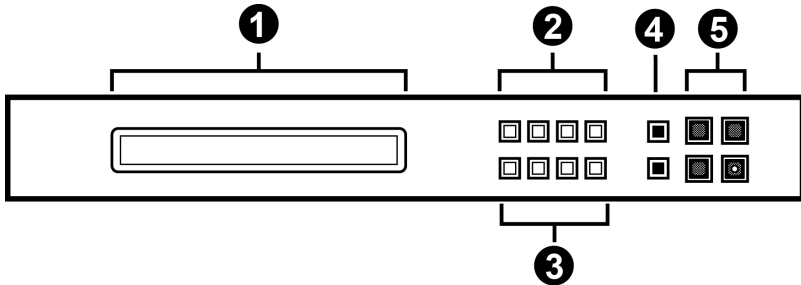

No.	Component	Description
1	LCD display	The LCD display gives a quick view of all port connections, and shows the various options for configuring and operating the VM0404HB. For full details, see <i>Main Screen</i> , page 17.
2	input pushbuttons	These pushbuttons refer to the HDMI input ports found on the VM0404HB rear panel. Press to select the input port. These pushbuttons may also correspond to menu options, connection profiles (P1–P4) and so on. Note: The INPUT (1–4) front panel pushbuttons have built-in LEDs that light to indicate they have been selected.
3	output pushbuttons	These pushbuttons refer to the HDMI output ports found on the VM0404HB rear panel. Press to select the output port. These pushbuttons may also correspond to connection profiles (P5–P8). Note: The OUTPUT (1–4) front panel pushbuttons have built-in LEDs that light to indicate they have been selected.
4	Prev / Next pushbuttons	These pushbuttons allow you to cycle through the menu options on the LCD display.
5	function pushbuttons	The function pushbuttons (MENU , PROFILE , ENTER and CANCEL) are for navigating the LCD built-in configuration utility. For full details, see <i>Front Panel Pushbuttons</i> , page 15. Note: The MENU and PROFILE front panel pushbuttons have built-in LEDs that light to indicate they have been selected.

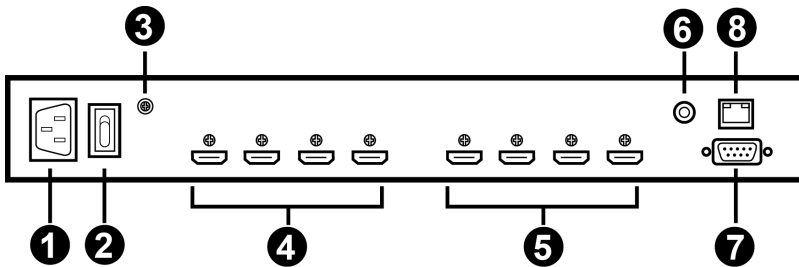
VM0404HB Rear View

No.	Component	Description
1	power socket	This is a standard 3-pin AC power socket. The power cord from an AC source plugs in here.
2	power switch	This is a standard rocker switch that powers the unit on and off.
3	grounding terminal	The grounding wire attaches here. See <i>Grounding</i> , page 12, for further details.
4	HDMI output ports	The cables from your HDMI display devices plug into these ports.
5	HDMI input ports	The cables from your HDMI source devices plug into these ports.
6	external IR receiver port	Connect the IR Receiver unit included with your product via this 3.5 mm mini stereo jack.
7	RS-232 serial port	Connect a computer or high-end system controller via this serial port.
8	Ethernet port	In order to access the VM0404HB's Browser Graphical User Interface (GUI), the VM0404HB must be connected to your network. The cable that connects the VM0404HB to your LAN plugs in here. See <i>Cable Connection</i> , page 13, for further details

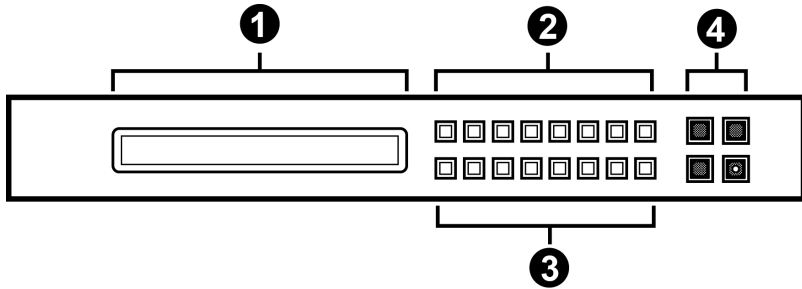
VM0808HB Front View

No.	Component	Description
1	LCD display	The LCD display gives a quick view of all port connections, and shows the various options for configuring and operating the VM0808HB. For full details, see <i>Main Screen</i> , page 17.
2	input pushbuttons	These pushbuttons refer to the HDMI input ports found on the VM0808HB rear panel. Press to select the input port. These pushbuttons may also correspond to menu options, connection profiles (P1–P8) and so on. Note: The INPUT (1–8) front panel pushbuttons have built-in LEDs that light to indicate they have been selected.
3	output pushbuttons	These pushbuttons refer to the HDMI output ports found on the VM0808HB rear panel. Press to select the output port. These pushbuttons may also correspond to connection profiles (P9–P16). Note: The OUTPUT (1–8) front panel pushbuttons have built-in LEDs that light to indicate they have been selected.
4	function pushbuttons	The function pushbuttons (MENU , PROFILE , ENTER and CANCEL) are for navigating the LCD built-in configuration utility. For full details, see <i>Front Panel Pushbuttons</i> , page 15. Note: The MENU and PROFILE front panel pushbuttons have built-in LEDs that light to indicate they have been selected.

VM0808HB Rear View

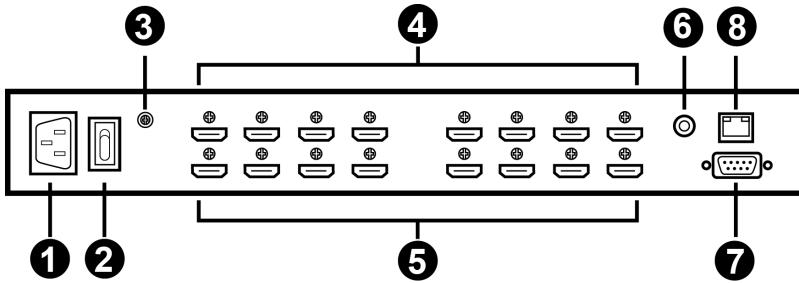

No.	Component	Description
1	power socket	This is a standard 3-pin AC power socket. The power cord from an AC source plugs in here.
2	power switch	This is a standard rocker switch that powers the unit on and off.
3	grounding terminal	The grounding wire attaches here. See <i>Grounding</i> , page 12, for further details.
4	HDMI output ports	The cables from your HDMI display devices plug into these ports.
5	HDMI input ports	The cables from your HDMI source devices plug into these ports.
6	external IR receiver port	Connect the IR Receiver unit included with your product via this 3.5 mm mini stereo jack.
7	RS-232 serial port	Connect a computer or high-end system controller via this serial port.
8	Ethernet port	In order to access the VM0808HB's Browser Graphical User Interface (GUI), the VM0808HB must be connected to your network. The cable that connects the VM0808HB to your LAN plugs in here. See <i>Cable Connection</i> , page 13, for further details

IR Remote Control

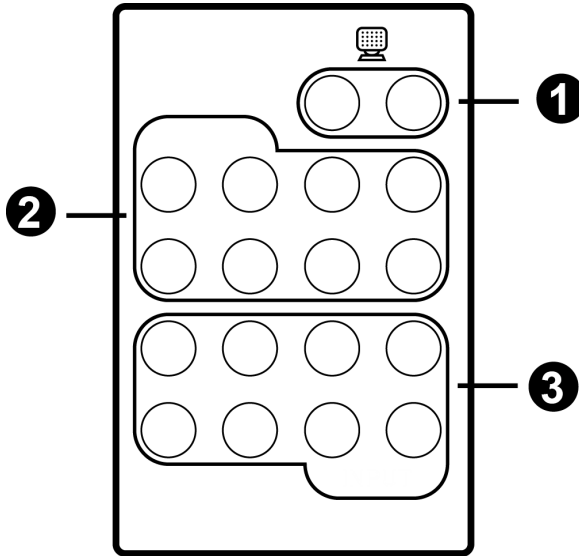

No.	Component	Description
1	power ON/OFF	Use the ON and OFF pushbuttons to turn the Output displays on or off – by individual port, or all ports. (see <i>IR Remote Control Operation</i> , page 32)
2	output pushbuttons 1–8	Press Output display pushbuttons 1–8 to select the Output display you want to configure (see <i>IR Remote Control Operation</i> , page 32).
3	input pushbuttons 1–8	Press Input source pushbuttons 1–8 to select the Input source you want to display on a selected output (see <i>IR Remote Control Operation</i> , page 32).

Note: The VM0404HB's IR remote control only supports use the 1~4 Input and 1~4 Output pushbuttons.

This Page Intentionally Left Blank

Chapter 2

Hardware Setup



1. Important safety information regarding the placement of this device is provided on page 79. Please review it before proceeding.
2. Make sure that the power to all devices connected to the installation are turned off. You must unplug the power cords of any computers that have the Keyboard Power On function.

Rack Mounting

The VM0404HB / VM0808HB can be mounted in a 19" (1U) system rack. For the most convenient front panel pushbutton configuration and operation at the local site, mount the unit at the front of the rack, as follows:

1. Use the M3 x 6 Phillips head hex screws supplied with the Mounting Kit to screw the rack mounting brackets onto the front of the unit.

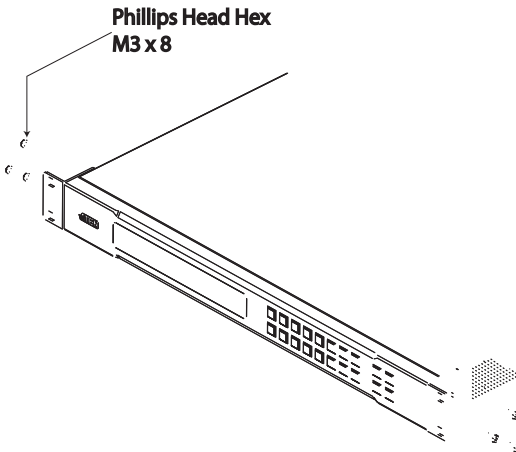

2. Position the unit in the front of the rack and align the holes in the mounting brackets with the holes in the rack.
3. Screw the mounting brackets to the rack.

Grounding

To prevent damage to your installation, it is important that all devices are properly grounded.

1. Use a grounding wire to ground the VM0404HB / VM0808HB by connecting one end of the wire to the grounding terminal, and the other end of the wire to a suitable grounded object.

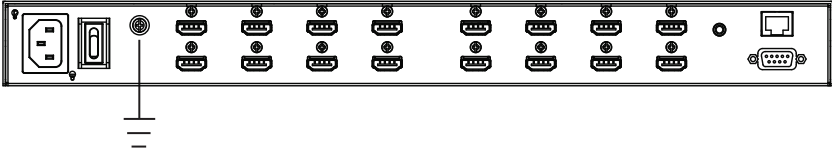

2. Make sure that all devices in your VM0404HB / VM0808HB installation are properly grounded.

Cable Connection

To Install the VM0404HB / VM0808HB, refer to the installation diagram on the following page (the numbers in the diagram correspond to the steps below), and do the following:

1. Use a grounding wire to ground the unit by connecting one end of the wire to the grounding terminal, and the other to a suitable grounded object.

Note: Do not omit this step. Proper grounding helps to prevent damage to the unit from surges or static electricity.

2. To access the web interface or use the Video Matrix Control app, plug a Cat 5e cable from the LAN into the VM0404HB / VM0808HB's Ethernet port.

Note: For more information on the Video Matrix Control app, see *Video Matrix Control App User Manual*.

3. If you are using the serial control function, use an appropriate RS-232 serial cable to connect the computer or serial controller to the VM0404HB / VM0808HB's female RS-232 port.
4. Connect up to 4 (VM0404HB) or 8 (VM0808HB) HDMI video sources to the HDMI input ports.
5. Connect up to 4 (VM0404HB) or 8 (VM0808HB) HDMI display devices to the HDMI output ports.
6. Connect the IR Receiver into the external IR receiver input port.
7. Plug the supplied power cord into the power socket, and then into an AC power source.
8. Power on the VM0404HB / VM0808HB and all devices in the installation.

Installation Diagram

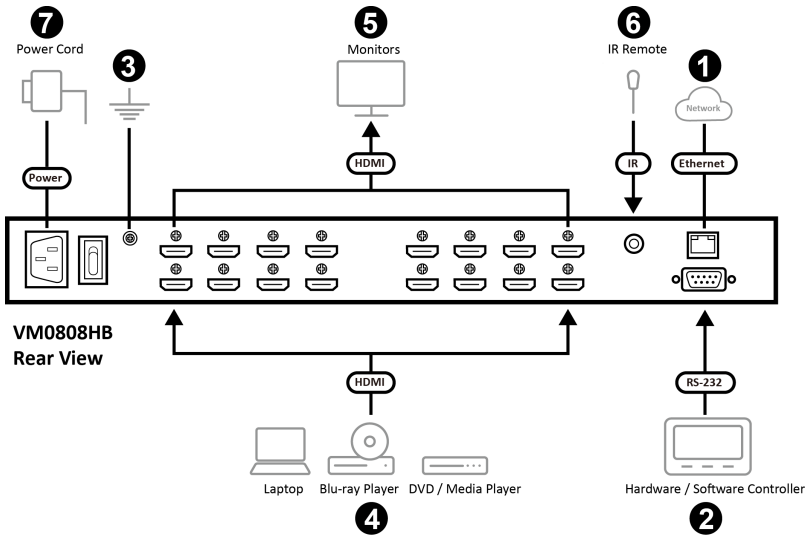

Chapter 3

Front Panel Configuration

Overview

The VM0404HB / VM0808HB can be configured and operated locally via the front panel LCD/pushbuttons and IR Remote Control; remotely over a standard TCP/IP connection via graphical user interface (GUI) using a web browser; via a remote terminal session using Telnet; or by a RS-232 serial controller.

The Front Panel Operation is discussed in this chapter. Web GUI Operation is discussed in Chapter 4, and RS-232 Serial Control is discussed in Chapter 5.

Front Panel Pushbuttons

The front panel features an LCD display and pushbuttons for convenient operation locally. This allows users to perform operations such as selecting which source shows on which display, viewing the IP settings, configuring the serial port, setting the EDID Mode / CEC / Output Status, selecting security settings, and loading/saving profiles.

Note the following front panel pushbutton functions:

- ◆ Use the **MENU** pushbutton to access the Menu page options: IP Setting, Serial Port Setting, Operation Mode, Security Mode, and Save to a Profile (see *LCD Menu Organization*, page 21).
- ◆ Use the **PROFILE** pushbutton to switch between the connection profiles which have been added to the Profile List (see *Profile List*, page 40). Pressing this pushbutton for longer than 3 seconds displays the Save to a Profile page (see *Save to a Profile*, page 29).
- ◆ Use the **CANCEL** pushbutton to go back to a previous page, return to the Main Screen, stop or exit an operation.
- ◆ Use the **ENTER** pushbutton to select options and confirm operations.
- ◆ Use the **INPUT / OUTPUT (1–4)** or **(1-8)** pushbuttons to select the Input/Output port. These pushbuttons may also correspond to menu options, connection profiles, and so on.
- ◆ The VM0404HB provides **▲ / ▼** (Prev/Next) pushbuttons to navigate the menus.
- ◆ Use pushbuttons **7/8** (Prev/Next) to navigate the VM0808HB menus.

Enter Password

Upon VM0404HB / VM0808HB startup, check the front panel LCD to view the loading progress. If the Password screen / LCD Menu fails to load, an error message displays. Reset the unit and try again.

If you are accessing the VM0404HB / VM0808HB for the first time, the Password screen appears as soon as the LCD loading process is done. Enter the default password 1234 to continue to the Main Screen (see *Main Screen*, page 17).

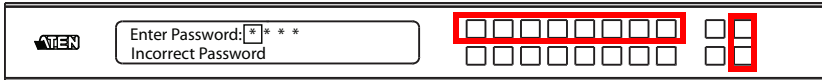

Additionally, the Password Screen appears if the VM0404HB / VM0808HB has been configured to require a password for Front Panel operation (see *Security Mode*, page 27).

To enter a password, do the following:

1. In the **Enter Password** field, check that the cursor is at the first asterisk (*) and flashing.
2. Use the front panel Input Port pushbuttons (1–4 or 1–8) to enter the 4-digit password. After the fourth digit has been entered correctly, the Main Screen displays.
3. Press **Cancel** to clear the password. The digits revert to 4 asterisks and the cursor goes back to the first asterisk.

-
- Note:**
1. The VM0404HB / VM0808HB password can be any 4-digit combination between 1111 to 4444 (VM0404HB) or 1111 to 8888 (VM0808HB). The default password is 1234.
 2. If you enter an incorrect password, the cursor goes back to the first digit and reverts to flashing. The Incorrect Password message displays at the bottom of the screen, but clears as soon as a new password is entered.
 3. If Password option is Enabled (see *Security Mode*, page 27), the LCD display time-out is 5 minutes by default.
-

Main Screen

The Main Screen shows the Input ports in the top row, which are tied to the Output ports shown in sequential order (1–4 or 1–8) at the bottom row.



- ◆ The front panel pushbutton label (1–4 or 1–8) corresponds to the **Input** ports and **Output** ports on the unit's rear panel.
- ◆ Use the **Menu** pushbutton to view the LCD Menu (see *LCD Menu Organization*, page 21).
- ◆ Use the **Profile** pushbutton to switch between profile connections (see *Profile List*, page 40).

Port Switching

From the Main Screen, users can configure the Input-to-Output port connections to associate an Input source device to an Output display.

Input Port Selection

Use the Input Port pushbuttons to select the Input port you want to configure.



To select which input source displays on each output port, do the following:

1. Press any Input port pushbutton (1–4 or 1-8). The Output port LED(s) tied to the said Input port will begin to flash. Available output port LED(s) will light up (steady).

In the example below, pressing Input port **1** shows it is tied to Output ports **1** and **2**.

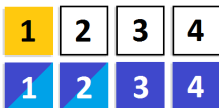

(Continues on next page.)

(Continued from previous page.)

- To disconnect an Output port from an Input port, press the corresponding Output port pushbutton.

In the example below, Output port **2** has been disconnected from Input port **1**.

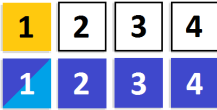

- To switch to another Input port, press any Input port pushbutton. The Output port LED(s) tied to the said Input port will flash.

In the example below, pressing Input port **2** shows it is tied to Output ports **3** and **4**.



- To connect Output port **2** to Input port **2** in the example above, press the Output port **2** pushbutton. The Output port **2** LED will also begin to flash (0.5 sec on, 0.2 sec off). This indicates that Input port **2** is now connected to Output ports **2**, **3** and **4**.



Once the signal from the selected Input port is successfully tied to the Output port, the LEDs turn off and the LCD information is updated.

Note: 1. Pressing an Input port a second time deselects it.

- Input ports that are not configured or tied to any output port do not in the LCD screen.
 - Pressing the **Cancel** pushbutton once stops the Input Port Selection operation and the LCD displays the active setting. Pressing the **Cancel** pushbutton again turns all LEDs off.
 - After 10 seconds of inactivity, all the LEDs turn off.
-

Output Port Selection

Use the Output Port pushbuttons to select the Output port you want to configure.



To select which output display corresponds to each input source device, do the following:

1. Press any Output port pushbutton (1–4 or 1–8).

In the example below, Output port **1** pushbutton has been pressed.

Available Input ports light up. Because no Input LEDs are flashing, no ports have already been assigned to Output port **1**.



2. If an Output port pushbutton is pressed a second time, it is deselected and the LED turns off.
3. To connect the selected Output port(s) to an Input port, press the Input port pushbutton. to which you want the Output port(s) tied. The newly selected Input port LED flashes (0.5 sec on, 0.2 sec off), and the LCD information is updated.

In the example below, pressing Input port **2** ties it to Output ports **2, 3** and **4**.



4. To switch Output ports **2, 3** and **4** to another Input port (and disconnect it from Input port **2**), press another Input port pushbutton to which you want them tied.

In the example below, Input port **3** has been pressed and is now connected to Output ports **2, 3** and **4**.



-
- Note:**
1. Pressing an Output port a second time deselects it.
 2. Pressing the **Cancel** pushbutton once stops the Output Port Selection operation, and the LCD displays the active setting. Pressing the **Cancel** pushbutton again turns all LEDs off.
 3. After 10 seconds of inactivity, all the LEDs turn off.
-

LCD Menu Organization

The VM0404HB / VM0808HB has a built-in configuration utility via the front panel LCD, which can be controlled by pressing the **MENU** and front panel Input pushbuttons (1–4 or 1–8). User can cycle through the menu options, starting from IP Setting page, in the order shown in the table below:

Menu Page	Sub-Menu Page(s)	
IP Setting	IP Address	
	Subnet Mask	
	Gateway	
Serial Port Setting	Baud Rate Setting	9600 / 19200 / 38400 / 115200
Operation Mode	EDID Mode	Default / Port1 / Remix / Customized
	CEC	On / NA
	Output Status	Video On / NA
Security Mode	Mode	None
		Password Enable
		Lock Screen
	Change Password	Old Password New Password
Save to a Profile	Save to a Profile No.	01–08 (VM0404HB); 01-16 (VM0808HB)
Play/Stop the Profile Schedule		

Note: The highlighted values are the default settings of the VM0404HB / VM0808HB.

Menu Pushbutton

Press the **MENU** pushbutton to switch between the Main Screen and LCD Menu page. When the Menu is active, the MENU pushbutton's built-in LED lights up:

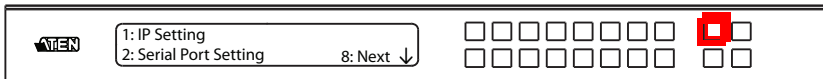

From the Menu page:

- ◆ Press **1** to go to the IP Setting page (see *IP Setting*, page 22)
- ◆ Press **2** to go to the Serial Port Setting page (see *Serial Port Setting*, page 23)

- ◆ Press **8** or **▼** to go to the next page(s) for the sub-menu pages
- ◆ Press **Menu** or **Cancel** to return to the Main Screen

IP Setting

The IP Setting page displays the VM0404HB / VM0808HB's IP configuration. The values in the LCD Menu are read-only and can be edited via the Browser GUI (*Network*, page 51).

IP Address / Subnet Mask

To view the VM0404HB / VM0808HB's IP address and Subnet Mask, do the following:

1. From the Menu page, press **1** to see the IP Setting submenu. The IP address and Subnet Mask are then shown.

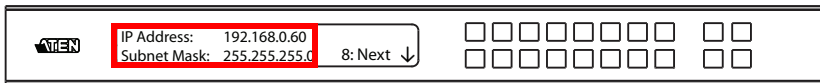

Note: The VM0404HB / VM0808HB default IP address is 192.168.0.60. The default Subnet Mask is 255.255.255.0

2. Press **8** or **▼** to go to the next page.
3. Press **Menu** to return to the Menu page.
4. Press **Cancel** to return to the previous page without saving.

Gateway

To view the VM0404HB / VM0808HB's gateway address, do the following:

1. From the Menu page, press **1** to see the IP Setting submenu, then press **8** or **▼** to get to the next page. The gateway address displays.

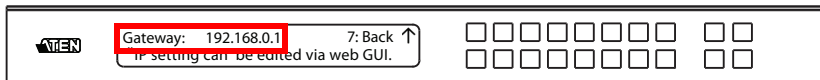

Note: The default Gateway is 192.168.0.1.

2. Press **7** or **▲** to go to the previous page.
3. Press **Menu** to return to the Menu page.
4. Press **Cancel** to return to the previous page without saving.

Serial Port Setting

To configure the VM0404HB / VM0808HB's baud rate for its serial port connection, press **2** to select Serial Port Setting from the Menu page.

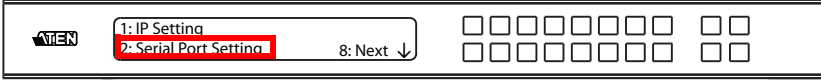

Baud Rate Setting

To set the VM0404HB / VM0808HB's baud rate, do the following:

1. Select **Baud Rate Setting** from the Serial Port Setting submenu by pressing **1**:



2. Press pushbuttons 1–4 to make your selection.



Baud Rate options are:

- ♦ 1: 9600
- ♦ 2: 19200
- ♦ 3: 38400
- ♦ 4: 115200

Note: The default baud rate is 19200.

3. Press **Menu** to return to the Menu page.
4. Press **Cancel** to return to the previous step without saving.

Operation Mode

The EDID Mode, CEC, and Output Status features can be configured from the Operation Mode page.

- ◆ EDID (Extended Display Identification Data) is used to have the VM0404HB / VM0808HB automatically apply a preset video configuration or EDID Mode, which utilizes the best resolution across different monitors
- ◆ Consumer Electronics Control (CEC) allows interconnected HDMI devices to communicate and respond to one remote control
- ◆ The Output Status shows whether the video/audio of an Output port is turned on or off and allows viewing and setting of the Output Resolution

To configure the VM0404HB / VM0808HB's operation mode settings from the Main Screen, use the **Menu** pushbutton to access the Menu page, press **8** or **✓** to navigate to the next page, then press pushbutton **1** to access the Operation Mode page.

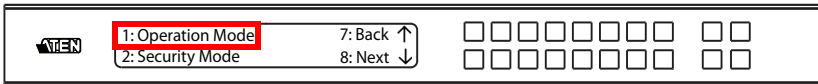

EDID Mode

To configure the EDID Mode, do the following:

1. From the Operation Mode page, press pushbutton **1**:

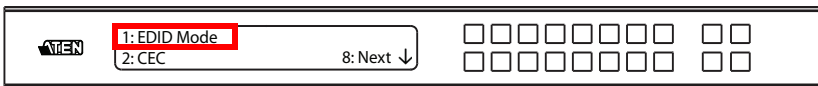

2. Press pushbuttons 1–4 to make your selection.

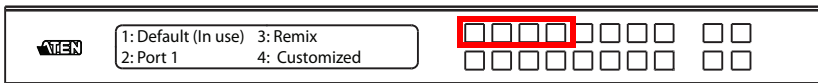

(Continues on next page.)

EDID Mode options are:

EDID Option	Description
1: Default	The default EDID is passed to all video sources.
2: Port1	The EDID from port1 is passed to all video sources.
3: Remix	Uses the EDID of each connected display according to its connection when the VM0404HB / VM0808HB is first powered on, or immediately after pressing 3 to select the Remix option.
4: Customized	Automatically retrieves and saves the EDID settings of a connected monitor/display device to an input source port. This can be configured using the Browser GUI. See <i>Customized EDID Settings</i> , page 56.

3. Press **Menu** to return to the Menu page.
4. Press **Cancel** to return to the previous step without saving.

CEC

To configure the CEC setting, do the following:

1. From the Operation Mode page, press pushbutton **2**:

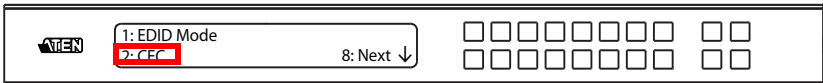

2. Press pushbuttons (1–4 or 1–8) to enable (**ON**) or disable (**NA**) the CEC feature for the output port. If the port does not support CEC, an **NA** is shown.

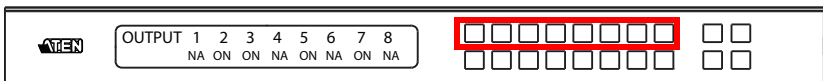

Note: The default CEC setting is NA.

3. Press **Menu** to return to the Menu page.
4. Press **Cancel** to return to the previous step without saving.

Output Status

To configure the Output Status settings for each output port, do the following:

1. From the Operation Mode page, press **8** or **✓** to go to the next page, then press pushbutton **1**:

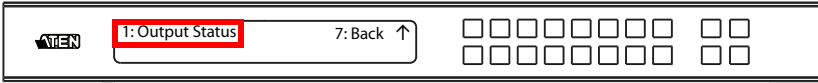

2. From the Output Status page, press **1** to select Video.



3. Press pushbuttons (1–4 or 1–8) to enable (**ON**) or disable (**NA**) the video/ audio of the output port.

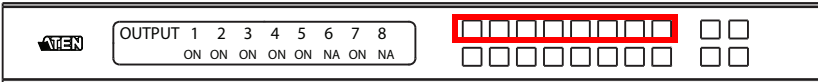

Note: The default Output Status setting is On.

4. Press **Menu** to return to the Menu page.
5. Press **Cancel** to return to the previous step without saving.

Security Mode

The Security Mode page allows users to manage the VM0404HB / VM0808HB's security-related settings. Three security modes are available: None, Password Enable, and Lock Screen. The VM0404HB / VM0808HB's password can also be changed here.

To configure the VM0404HB / VM0808HB's security settings from the Main Screen, use the **Menu** pushbutton to access the Menu page, press **8** or **▼** to navigate to the next page, then press pushbutton **2** to access the Security Mode page.

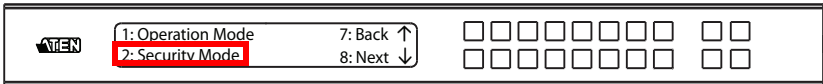

Mode

- To change the VM0404HB / VM0808HB's security mode, press pushbutton **1** from the Security Mode page.



- In the Mode menu, to disable security settings, press pushbutton **1**. The menu will then return to Security Mode. To require a password after the LCD display times out or is powered off/on, press pushbutton **2**. The menu will then return to the home screen.

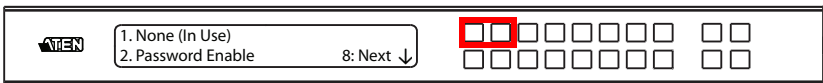

Note: If Password is Enabled, the LCD display's default time-out is 5 minutes. The VM0404HB / VM0808HB's default password is 1234.

- To enable a lock screen, press **8** or **▼** to navigate to the next page, then press pushbutton **1**. The menu will then return to the home screen. When Lock Screen is enabled, pressing any pushbutton from the home screen will trigger the following message: *Please press "Menu" to start.*

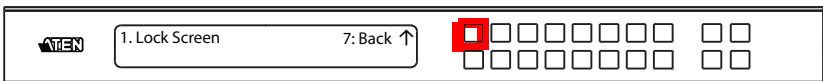

4. Press **Menu** to return to the Menu page.
5. Press **Cancel** to return to the previous step without saving.

Change Password

1. To change the password for accessing the unit, press pushbutton **2** from the Security Mode page.



2. In the Old Password field, the cursor flashes at the first digit. Enter the old password (see *Enter Password*, page 16). If the old password is entered correctly, you can proceed to the next step.



Note: If you entered an incorrect password, an error message appears and the cursor goes back to the first digit (flashing). The Incorrect Password message clears as soon as a new digit is entered.

3. In the New Password field, the cursor flashes at the first digit. Enter the new password using the front panel number pushbuttons VM0404HB: (1111–4444) or VM0808HB: (1111–8888).



4. Re-enter the new password in the following screen. The new password is applied by the VM0404HB / VM0808HB immediately.

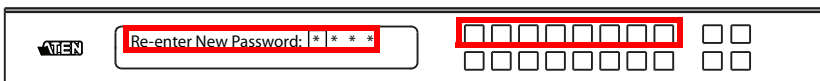

If the password you entered does not match the one entered in the previous screen, an error message appears. Enter the new password correctly.

5. Press **Menu** to return to the Menu page.
6. Press **Cancel** to return to the previous step without saving.

Save to a Profile

The switch allows users to store up to 8 (VM0404HB) or 16 (VM0808HB) (numbered P1-P8 or P1–P16) different connection profiles that can be saved and recalled later.

The active Input-to-Output port connections on the LCD Main Screen is the configuration saved to a profile. When a user loads a profile, the change is immediate and the profile number is shown on the lower right corner of the LCD screen.

To save a profile once the desired port connections are set, do the following:

1. Press the **Menu** pushbutton to access the Menu page, then **8** or **▼** twice to navigate to the next pages. Press pushbutton **1** to open the select Save to a Profile page.

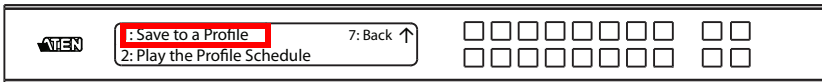

2. On the page that opens, you are asked to give the profile a number. Use the front panel number pushbuttons to select a profile number into which you want to save the configuration.



VM0404HB: Options are P1–P8 (when saving a profile via the LCD), where:

- ◆ Input port pushbuttons **1–4** correspond to Profile **P1** to **P4**
- ◆ Output port pushbuttons **1–4** correspond to Profile **P5** to **P8**

VM0808HB: Options are P1–P16 (when saving a profile via the LCD), where:

- ◆ Input port pushbuttons **1–8** correspond to Profile **P1** to **P8**
- ◆ Output port pushbuttons **1–8** correspond to Profile **P9** to **P16**

3. Press **Enter** to store the configuration – the LCD shows Profile Saved.
4. Press **Menu** to return to the Menu page,
5. Press **Cancel** to return to the previous step without saving.

Note: Access the Save to a Profile page quickly by pressing the **Profile** pushbutton for longer than 3 seconds.

Play/Stop the Profile Schedule

Inputting port pushbutton 2 will Play or Stop the active Profile Schedule.



If there's no pre-defined Profile Schedule, an error message shows.

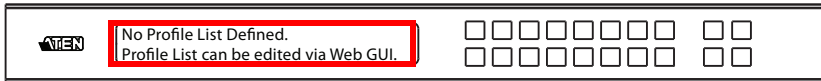

Profile Pushbutton

The **PROFILE** pushbutton lets users conveniently switch between connection profiles that have been saved or added to the Profile List (see *Profile List*, page 40).

When a Profile is in use, its profile number (P1-P8 or P1-P16) is shown on the lower right corner of the LCD display.



The Profile pushbutton functions as follows:

- ◆ After pressing the Profile pushbutton, available profile numbers will light up. The active profile number will flash. Use the Input/Output pushbuttons to switch to a specific profile (P1 to P8) or (P1 to P16). Note that:
 - ◆ **Input** ports **1 to 4** or **1 to 8** correspond to Profile **P1 to P4** or **P1 to P8**
 - ◆ **Output** ports **1 to 4** or **1 to 8** correspond to Profile **P5 to P8** (where Output Port 1=Profile 5, Output Port 2=Profile 6... Output Port 4=Profile 8) or **P9 to P16** (where Output Port 1=Profile 9, Output Port 2=Profile 10... Output Port 8=Profile 16)
- The LED of the selected pushbutton flashes, and the VM0404HB / VM0808HB immediately applies the port connections configured in the selected profile. The profile is valid when the LED lights steady.
- ◆ After pressing the Profile pushbutton, pressing it again will change to next profile in Profile Scheduling (see page 43), not the profile list. This feature is only available while a schedule is playing.
- ◆ Press the **Cancel** pushbutton to exit.

Note: If there are no profiles configured on the VM0404HB / VM0808HB device, an error message “*No Available Profile*” is displayed when the Profile pushbutton is pressed.

A **Profile**'s port connections can be edited using the front panel pushbuttons (see *Port Switching*, page 17) or from the *Connections* page of the Browser GUI (see *Connection Table*, page 37). Additionally, the Profile List can be configured via the Profile page of the Browser GUI (see *Profile List*, page 40).

IR Remote Control Operation

The IR remote control (*IR Remote Control*, page 9) included with the VM0404HB / VM0808HB can be used to:

- ◆ change the Input source of any Output display
- ◆ power on/off individual Output displays; or
- ◆ power on/off all Output displays simultaneously

Before using the remote control, a user must first plug the IR External Receiver into the rear panel of the VM0404HB / VM0808HB and place the receiver where the IR signal can be reached (see *IR Remote Control*, page 9).

Change the Input source of an Output display

To change the Input source of an Output display, using the remote control, do the following:

1. Press the **Output** port number (**1–4** or **1-8**) you want to change.
2. Within 2 seconds press the **Input** port number (**1–4** or **1-8**) you want the Output port to display.*
3. Repeat steps 1-2 to change additional ports.

Note: For the change to occur the Input number must be pressed within 2 seconds of pressing the Output number.

Power on/off individual Output displays

To power on/off individual Output displays, using the remote control, do the following:

1. Press the **Output** port number (**1–4** or **1-8**) you want to power on/off.
2. Within 2 seconds press the **ON** or **OFF** pushbutton.*
3. Repeat steps 1-2 to change the power status back on/off.

Note: If the **ON** or **OFF** pushbutton is pressed *after* 2 seconds of pressing the Output port number, all the displays are powered on or off instead of just the intended Output port.

Power on/off all Output displays

To power on/off all Output displays simultaneously, with the remote control, do the following:

1. Press the **ON** or **OFF** pushbutton.*
2. Repeat step 1 to simultaneously change back the power status of all Output ports, to on or off, respectively.

Note: The **ON** or **OFF** pushbuttons bring all displays to the same power status, regardless of the individual power statuses.

This Page Intentionally Left Blank

Chapter 4

Browser Operation

Overview

The VM0404HB / VM0808HB can be configured over a standard TCP/IP connection via its built-in Graphical User Interface (GUI). Because it can be accessed from anywhere over a network or the Internet, operators can easily log in via web browser. Security is ensured by password protection and user-configurable time-out. The VM0404HB / VM0808HB supports three levels of remote users with various privileges, and up to 16 users can log into the GUI at one time. For full details, see the sections that follow.

Logging In

To access the GUI, type the VM0404HB / VM0808HB's IP address into the address bar of any browser. If a Security Alert dialog box appears, accept the certificate – it can be trusted. The login screen appears:

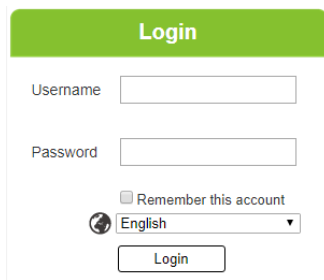

- ◆ The default IP address is **http://192.168.0.60**
- ◆ The default Username and Password are: **administrator / password**
- ◆ Enter the username and password, then click **Login**.
- ◆ The same user can not be logged in simultaneously.
- ◆ Use the drop-down menu to select the GUI language
 - ◆ English, French, German, Italian, Japanese, Korean, Portuguese, Russian, Spanish, Simplified Chinese and Traditional Chinese

Note: The username supports lower case letters only.

Main Page



The Main Page opens the **Connection Table**. This is where you configure the input to output connections and create profiles. The page is divided into four parts: the *Menu Bar*, *Connection Table*, *Profile List*, and *Profile Scheduling*.

The screenshot displays the ATEN VM0808HB web interface. At the top, the header includes the ATEN logo, the model number 'VM0808HB', and the device name '8x8 True 4K HDMI Matrix Switch'. A settings icon is visible in the top right corner. Below the header, a green navigation bar contains 'Import Profiles' and 'Export Profiles' buttons. The main content area is titled 'CONNECTION TABLE' and features a 'Switch to Grid View' button, an 'Auto Apply' checkbox, and an 'Apply' button. There are also checkboxes for 'Mute All', 'Blank All', and 'Splitter Mode'. The central part of the interface shows an 8x8 grid of colored squares, each representing a port connection, numbered 01 through 08. To the right of the grid is a 'Profile List' section with a vertical scrollbar and a list of ports labeled 'Port_In_1' through 'Port_In_8'. At the bottom of the interface, there is a 'PROFILE SCHEDULING' section with a right-pointing arrow.

Menu Bar

The Menu Bar consists of Model Number, Import Profiles, Export Profiles, the Settings/Profile List icon, and the Logout button.

This close-up screenshot shows the top navigation bar of the web interface. It includes the ATEN logo, the model number 'VM0808HB', and the device name '8x8 True 4K HDMI Matrix Switch'. On the right side of the bar, there is a settings icon and the text 'Settings'. Below the bar, a green navigation bar contains 'Import Profiles' and 'Export Profiles' buttons. The user's name 'Hi, administrator.' and a 'Logout' button are also visible.

- ◆ Click the Model Number to add a description for the Video Matrix switch that you wish to show after the model number.
- ◆ Click **Import Profiles** or **Export Profiles** to import or export a configuration file (see page 42).
- ◆ Click **Settings**  or **Profile List**  to enter the System Settings (see page 45) or return to the **Connection Table** page.
- ◆ Click the **Logout** button to log out of the GUI.

Connection Table

The Connection Table shows the input to output connections. Each icon represents an output port and the connected display. The large number is the **Input** port selected for the display. The small number (upper-left corner) is the **Output** port for the display.



- ◆ Click an icon to choose a Video Input from the *Input* port menu in the right column, or drag and drop an Input port from the right column onto an icon.
- ◆ Click an icon and click the **Empty Port** (or drag and drop the Empty Port to an icon) to blank the Video Output.
- ◆ Check **Mute All** to turn off the audio for all output ports.
- ◆ Check **Blank All** to turn off the video for all output ports.
- ◆ Check **Splitter Mode** to select all icons, and then click an Input port to apply the Input source to all Output ports.
- ◆ Check **Auto Apply** to automatically apply any configuration change to the Connection Table.

Note: When the Connection Table is imported from a Profile and **Auto Apply** is enabled, with any configuration change you will be prompted to:



- v Save the change to both the Profile and the current Connection Table by selecting **Yes**, or

- v Save the change to the Connection Table only by selecting **No**.
(see *Profile List*, page 40 for details)

- ◆ Click **Apply** to save the configuration changes to the Connection Table.

Note: When the Connection Table is imported from a Profile, clicking **Apply** will be prompt to:

- v Save the changes to both the Profile and the current Connection Table by selecting **Yes**, or
- v Save the changes to the Connection Table only by selecting **No**.
(see *Profile List*, page 40 for details)

- ◆ Click  to view the Profile List (see *Profile List*, page 40); click  to return to the Connection Table.
- ◆ Click  to use an alternate method for configuring the input to output connections (see *Grid View*, page 39).

Output Icon



Option	Description
Output Icon	<p>Click or drag an Output icon(s) to highlight it in green and choose a Video Input from the Input port menu to set the input to output connections.</p> <p>The large number is the Video Input port selected for the display.</p> <p>The small number (upper-left corner) is the Output port of the display.</p>
Mute / Video 	<p>Click the speaker icon to mute the audio on/off.</p> <p>Click the video icon to turn the video off/on.</p>

Grid View

The Grid View allows you to select the **Input** to **Output** connections using a simple grid.

		Output Port							
		o01	o02	o03	o04	o05	o06	o07	o08
Input Port	i01	<input checked="" type="checkbox"/>							<input checked="" type="checkbox"/>
	i02		<input checked="" type="checkbox"/>						
	i03			<input checked="" type="checkbox"/>					
	i04				<input checked="" type="checkbox"/>				
	i05					<input checked="" type="checkbox"/>			
	i06						<input checked="" type="checkbox"/>		
	i07							<input checked="" type="checkbox"/>	
	i08								<input checked="" type="checkbox"/>

- ◆ Select a box to coordinate *Input Ports* to *Output Ports*. By default, ports will be aligned so that *i01* will correspond to *o01*, etc.
- ◆ **Uncheck** a box to disable the video for that Output Port. The column will no longer contain a yellow box.
- ◆ **Check** an *Input Port* radio button to align all *Output Ports* to that *Input Port*.
- ◆ Click **Apply** to save the settings to the Connection Table.

Note: When the Connection Table is imported from a Profile and **Auto Apply** is enabled, with any configuration change you will be prompted to:

- v Save the change to both the Profile and the current Connection Table by selecting **Yes**, or
 - v Save the change to the Connection Table only by selecting **No**.
(see *Profile List*, page 40 for details)
-

Profile List

The *Profile List* lets you configure the input to output port connections by creating profiles to use. You can store up to 8 (VM0404HB) or 16 (VM0808HB) differently configured profiles that can be saved and played by two methods: locally via the unit's front panel pushbuttons (*Adding/Playing a Profile*, page 40) and via the web GUI.

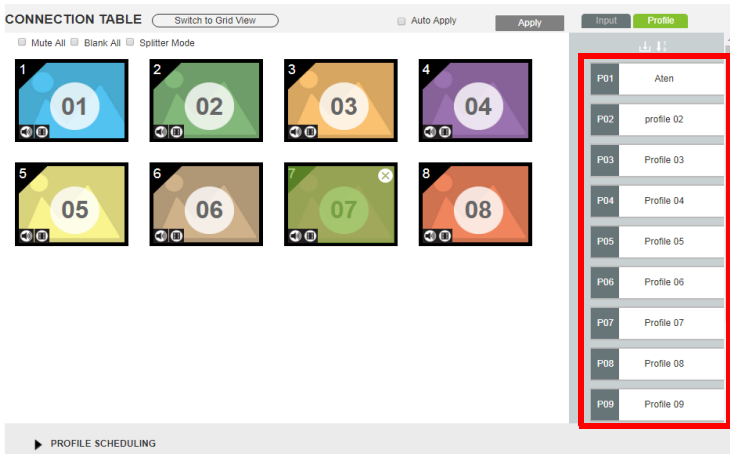

Adding/Playing a Profile

To configure a profile:



1. Configure the input to output connections from the Connection Table (see page 37).
2. Save the Connection Table to a **Profile** by clicking . You will be prompted to input a profile name to save it.

Save a New Profile

Please name it

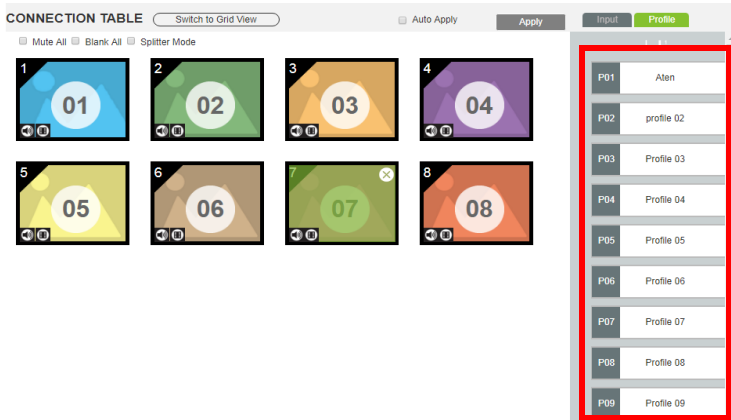
3. New profiles appear in the *Profile List*, as shown here:



4. Click a Profile from the Profile List opens a drop-down menu. Click  **Import** to import the configurations to the Connection Table, and then click  to start the connections.

Profile List Options

Clicking a Profile from the Profile List opens a drop-down menu with options.

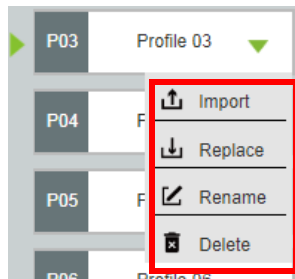

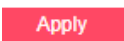
Option	Description
Import	Click to import the configurations to the Connection Table, and then click Apply to start the connections.
Replace	Click to save the edited Connection Table to the imported Profile.
Rename	Click to rename the profile.
Delete	Click to delete the profile from the Profile list.
	Click to save the edited configuration to the Connection Table/imported Profile. On the pop-up dialog, select Yes to save the change to both the Profile and the Connection Table, or select No to save the change to the Connection Table only.

Importing/Exporting a Profile

To export the VM0404HB / VM0808HB’s connection Profiles, do the following:

1. Click **Export Profiles** . A configuration file will then begin downloading.

To import connection Profiles to the VM0404HB / VM0808HB, do the following:

1. Click **Import Profiles** .
2. Browse to the configuration file, select it and click **Open**.



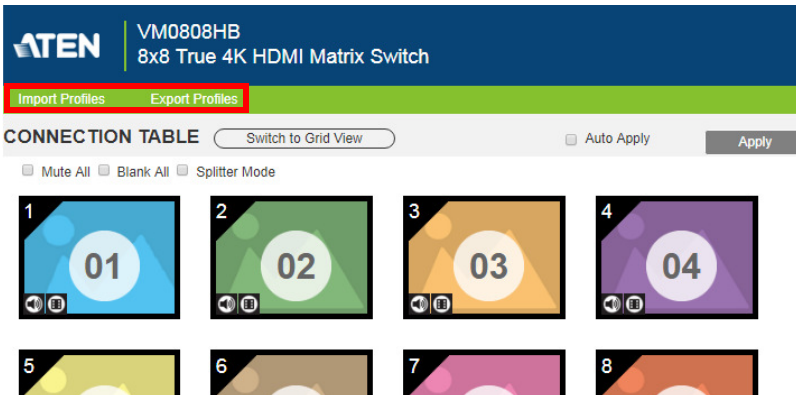

Note: Importing a connection profile database will overwrite the current profiles.

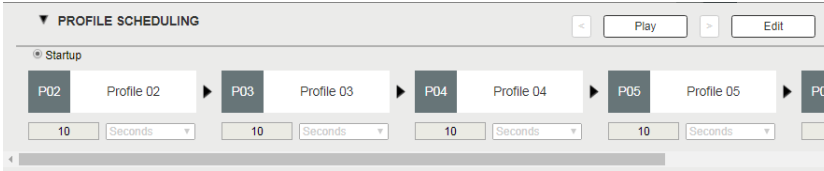

Profile Scheduling

Profile Scheduling is located below the Connection Table. Scheduling allows you to queue and play connection profiles in sequence for a specific amount of time.



Option	Description
	Click to edit profile schedule.
	Click to play profile schedule.
	When a Profile Schedule is playing the <i>On Sequence</i> box will appear in the Play window.
	Click to stop profile schedule.
	Click to change to next or previous profile when a profile schedule is playing.

(Continues on next page.)

After selecting **Edit**, you will be presented with the following options.

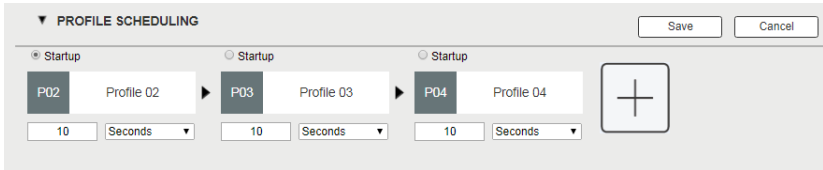

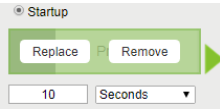
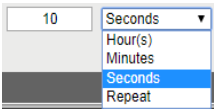
Option	Description
	<p>Click to add profiles to the schedule in the order to be played, left to right, then set the amount of time each profile plays.</p>
	<p>Click a profile for a pop-up menu to appear:</p> <ul style="list-style-type: none"> ◆ Select Startup to use the profile as the starting point for the schedule. ◆ Click Replace to replace the selected profile with another profile. ◆ Click Remove to delete the profile from the schedule. ◆ Use < > to change the profile's position in the schedule.
	<p>Use the drop-down menu to select the duration (Hours, Minutes, or Seconds) and enter the amount of time for the profile to play. After the time expires, the schedule switches to the next profile.</p> <p>Use Repeat to stop switching between schedules and stay on the currently selected profile. If Repeat isn't used, the schedule will loop back to the first profile. If Repeat is used, a specific number of hours, minutes and seconds cannot be set and later profiles will not be played.</p>
<p>Save</p>	<p>Click Save to save the schedule as it appears. After saving, the Profile Scheduling window will close.</p>
<p>Cancel</p>	<p>Click Cancel to discard changes and return to the Profile Schedule page.</p>

System Settings

Click the *Settings* link from the Main page for the System Settings to open on the **General** page:

The screenshot shows the ATEN VM0808HB web interface. The top navigation bar includes tabs for General, User Account, Port Name, Network, EDID, and Maintenance. The main content area is titled 'Serial Settings' and features a 'Baud Rate' dropdown menu set to 115200. Below this is the 'Device Info' section, which contains a table with columns for Device, Model Name, and F/W Version. The table lists 'Video Matrix' with Model Name 'VM0808HB' and F/W Version 'V1.0.072'. Underneath the table is a list of ports from Port1 to Port8, each with a status indicator: Port1 is active (indicated by a horizontal line), while Ports 2 through 8 are inactive (indicated by a red 'X'). At the bottom of the page, there is an 'Other' section with a 'Language' dropdown menu set to 'English', and 'Save' and 'Cancel' buttons.

- ◆ The *General* page allows you to edit Baud and Language, and view device information.
- ◆ The *User Account* page allows you to add and edit user accounts.
- ◆ The *Port Name* page allows you to name each input and output port.
- ◆ The *Network* page allows configuration of the network settings.
- ◆ The *EDID* page is used to set the EDID modes.
- ◆ The *Maintenance* page is for upgrading the device's firmware and backing up/restoring the system configuration file.
- ◆ The *HDCP* page lets users view and set HDCP key settings.
- ◆ The *CEC* page allows users to control port CEC settings.
- ◆ Click **Profile List** to return to the Main page.

General

The *General* page has three sections: Serial Settings, Device Info, and Other.

Serial Settings

Baud Rate

Device Info

Device	Model Name	F/W Version
Video Matrix	VM0808HB	V1.0.072
Port1	---	
Port2	-X-	
Port3	-X-	
Port4	-X-	
Port5	-X-	
Port6	-X-	
Port7	-X-	
Port8	-X-	

Other

Language

Serial Settings

Use the Baud Rate drop-down menu to select a serial port setting. Options include: 9600, 19200, 38400 and 115200.

Device Info

This section lists the device's type, Model Name, Firmware Version and port statuses.

Device Info

Device	Model Name	F/W Version
Video Matrix	VM0808HB	V1.0.072
Port1	---	
Port2	-X-	
Port3	-X-	

Other

Use the **Language** drop-down menu to select a preferred user interface language. Options include: English, French, German, Italian, Japanese, Korean, Portuguese, Russian, Spanish, Simplified Chinese and Traditional Chinese.

User Account

The *User Account* page lets you add, edit, or delete users and change the password for accessing the VM0404HB / VM0808HB's GUI.

Note: This is an Administrator only function.

User Name	Level	Description
administrator	Administrator	Default_User
user_1	Basic User	User_Account

- ◆ **Add account** – Click the *Add account* button to add another user to the list. The VM0404HB / VM0808HB supports up to 32 users and allows up to 16 concurrent logins (see page 48 for more details).
- ◆ **Edit** – Click the *Edit* button to change user information. This option allows an Administrator to edit individual accounts.

User Name	Level	Description	
Edit 111111	Administrator	111111	
Edit 12345	Administrator		
Edit administrator	Administrator	Default_user	

- ◆ **Edit** – Rename the user account, set the password, add a description, and set the user's permission level (see page 49 for more details).
- ◆  – Removes the user account.
- ◆ The default username and password are: administrator/password.

Add Account

Use the Add Account / Edit buttons to create a user account, set the user's password, add a description, and set the user's permission level (see page 49) when accessing the VM0404HB / VM0808HB's GUI.

Add account

Username

Password

Confirm Password

Please enter 5-16 characters without "+@#[]:;=<?>() space &

Description

Permission Level

Administrator Connections, Open/Save Profiles, Manage users

Advanced User Connections, Open/Save Profiles

Basic User Connections, Open Profiles

- ◆ Fill in a username or edit an existing one.
- ◆ Enter a password and re-type the password to confirm.

Note: Usernames and passwords accept multi-lingual characters, and must be 5–16 alphanumeric characters (excluding ;=[]+=/?\). Passwords are case sensitive. Usernames only support lower case letters.

- ◆ Add or edit the description for the user.
- ◆ Select the permission level that you want to grant the user (see , page 48).
- ◆ Click **Create User** to save the data.
- ◆ Click **Cancel** to discard the changes and exit.
- ◆ If a user is logged into the VM0404HB / VM0808HB's GUI, the user settings cannot be edited, and the fields in this screen are grayed out.

Permission Level

At the bottom of the New/Edit User page is the permission section, which is used to set a user's permission level.

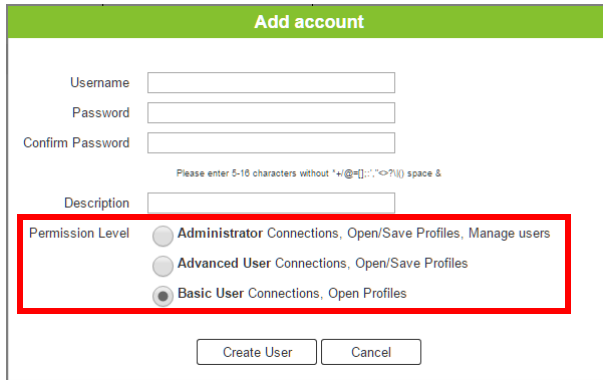

The screenshot shows a web form titled "Add account" with a green header. The form contains several input fields: "Username", "Password", "Confirm Password", and "Description". Below the "Description" field is a "Permission Level" section with three radio button options. The "Basic User" option is selected. The "Permission Level" section is highlighted with a red rectangular box. At the bottom of the form are two buttons: "Create User" and "Cancel".

Username

Password

Confirm Password

Please enter 5-16 characters without *+!@#%&'<>?|) space &

Description

Permission Level

- Administrator Connections, Open/Save Profiles, Manage users
- Advanced User Connections, Open/Save Profiles
- Basic User Connections, Open Profiles

Create User Cancel

The three available permission levels are as follows:

- ◆ **Administrator** – this level provides full access and control of the VM0404HB / VM0808HB, in addition to full User Management privileges.
- ◆ **Advanced User** – this level provides full access and control with no User Management privileges.
- ◆ **Basic User** – this level only provides basic functions (connections and open profiles).

Port Name

The *Port Name* page lets you name the input and output ports for easy identification.

The screenshot displays two side-by-side configuration panels. The left panel, titled 'Output Port', contains eight rows. Each row has a port label (Port1 to Port8), a numeric ID (01 to 08), and a text input field containing a default name (Port_Out_1 to Port_Out_8). The right panel, titled 'Input Port', also contains eight rows with similar labels, IDs, and text input fields containing default names (Port_In_1 to Port_In_8). Below these panels are two buttons: 'Save' and 'Cancel'.

- ◆ To name an Input/Output port, enter a descriptive name of up to 16 multi-language characters (excluding ;=][+="/?\\) in the corresponding field and click **Save**.
- ◆ Language characters available include: English, French, German, Italian, Japanese, Korean, Portuguese, Russian, Spanish, Simplified Chinese and Traditional Chinese.
- ◆ To change an Input/Output port's name, enter another value and click **Save**.
- ◆ Input and Output port names can be the same.
- ◆ Press **Cancel** to go back a level, return to the initial screen, or exit.

Note: The VM0404HB will only have four Output Port and four Input Port fields to name.

Network

The *Network* page lets you configure the IP settings, website timeout, and Telnet settings for connecting to the VM0404HB / VM0808HB.

DHCP	<input checked="" type="radio"/> Enable <input type="radio"/> Disable
IP Address	<input type="text"/>
Subnet Mask	<input type="text"/>
Default Gateway	<input type="text"/>
Website Timeout	5 min ▾
MAC Address	00:10:74:AD:11:22
Telnet	<input checked="" type="radio"/> Enable <input type="radio"/> Disable

Enable DHCP to allow the DHCP server to assign an IP address to the VM0404HB / VM0808HB. Select **Disable** to enter your own static IP address settings for the device.

Click **Reset** to use the following default values:

- ◆ IP Address – 192.168.0.60
- ◆ Subnet Mask – 255.255.255.0
- ◆ Default Gateway – 192.168.0.1
- ◆ Website Timeout* – 5 minutes
- ◆ Telnet Enabled

Enter the values, then click **Save**. Changes may take a few seconds and after refreshing the page automatically redirects you to the IP address specified.

* This option controls how long an inactive web connection stays logged into the VM0404HB / VM0808HB. Use N/A to disable this option. Other options include 5, 10, 30 and 60 minutes. Any changes will take effect immediately.

EDID

The *EDID Settings* page lets users view and select an EDID Mode so that the VM0404HB / VM0808HB can use the best resolution for its display(s).

The screenshot displays the EDID Settings interface, which is divided into several sections:

- EDID Mode:** A vertical panel on the left containing radio buttons for "ATEN Default" (selected), "Port1 Mode", "Remix", and "Customized". Below these is an "Apply" button and a "Port EDID Status" section listing ports 1 through 8, all currently set to "ATEN Default".
- EDID & CEA Description:** A central panel with three columns:
 - EDID:** A numbered list of 10 items: 1. Vendor/Product Identification, 2. EDID Structure/Revision, 3. Basic Display/Feature, 4. Color Characteristics, 5. Established Timings, 6. Standard Timings, 7. Detail Timing/Display Description 1, 8. Detail Timing/Display Description 2, 9. Monitor Description, 10. Monitor Description.
 - Model ID:** 0x0001
 - Manufacturer ID:** ATN
 - Serial Number:** 0x0000275F
 - Manufacture Date:** 2018 Week 8
 - Week of Manufacture:** 8
 - Year of Manufacture:** 2018
 - CEA:** A numbered list of 5 items: 1. Display Support, 2. Video Data, 3. Audio Data, 4. Speaker Allocation, 5. Vendor Specific Data.
- Tips:** A right-hand panel providing guidance:
 - ATEN Default Mode:** "All ports' EDID are the same as the hardware default EDID."
 - Port1 Mode:** "All ports' EDID are the same as Port1 EDID."
 - Remix:** "All ports' EDID use the lowest resolution display."
 - Customized Mode:** "The EDID Wizard is only enabled if the EDID is in 'Customized Mode'."

Note: The EDID Mode can also be selected via the Front Panel pushbuttons – see *EDID Mode*, page 24.

Extended Display Identification Data (EDID) is a data format that contains a display's basic information and is used to communicate with the video source/system.

EDID Mode

In the left panel of the page, users can select a pre-configured EDID Mode using the **EDID Mode** radio buttons.

EDID Mode

ATEN Default
 Port1 Mode
 Remix
 Customized

Apply

EDID & CEA Description

EDID	
1. Vendor/Product Identification	Model ID: 0x0001
2. EDID Structure/Revision	Manufacturer ID: ATN
3. Basic Display/Feature	Serial Number: 0x000275F
4. Color Characteristics	Manufacture Date: 2018 Week 8
5. Established Timings	Week of Manufacture: 8
6. Standard Timings	Year of Manufacture: 2018
7. Detail Timing/Display Description 1	
8. Detail Timing/Display Description 2	
9. Monitor Description	
10. Monitor Description	

CEA

1. Display Support
2. Video Data
3. Audio Data
4. Speaker Allocation
5. Vendor Specific Data

Tips

ATEN Default Mode
All ports' EDID are the same as the hardware default EDID.

Port1 Mode
All ports' EDID are the same as the hardware default EDID.

Remix
All ports' EDID use the lowest resolution display.

Customized Mode
The EDID Wizard is only enabled if the EDID is in "Customized Mode".

Port EDID Status

Port 1 ATEN Default
Port 2 ATEN Default
Port 3 ATEN Default
Port 4 ATEN Default
Port 5 ATEN Default
Port 6 ATEN Default
Port 7 ATEN Default
Port 8 ATEN Default

Select the EDID Mode to use and click **Apply**. The VM0404HB / VM0808HB uses the settings configured for that EDID mode.

Options are:

- ◆ **ATEN Default:** All ports' EDID are the same as the hardware default EDID.
- ◆ **Port 1 Mode:** All ports' EDID are the same as Port 1's EDID.
- ◆ **Remix:** All ports' EDID use the best display resolution.
- ◆ **Customized:** See Customized Mode, see page 56.

Customized Mode

Use the *Customized* Mode to automatically retrieve and save the EDID settings of a connected monitor/display device to an input source port.

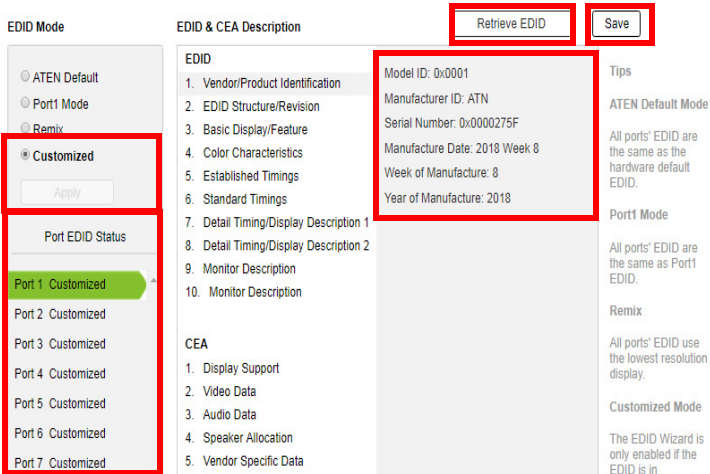

- ◆ In the left-most panel of the page, select **Customized** from the *EDID Mode* section and click **Apply**.
- ◆ **Port EDID Status:** Select which input source port you want to store the EDID configuration (VM0404HB: 01–04; VM0808HB: 01–08).
- ◆ **Retrieve EDID:** Click and a pop-up window appears to retrieve the EDID settings of a stored EDID configuration: *Customized EDID 01-08*, or *ATEN Default*. Select the port to retrieve:

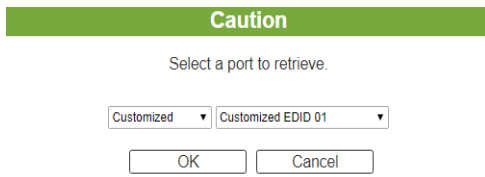

- ◆ The right panel displays a summary of the acquired EDID settings that you can edit. Click **Save** and select the configuration for the **Current** or **All Ports** for the duration of the session.

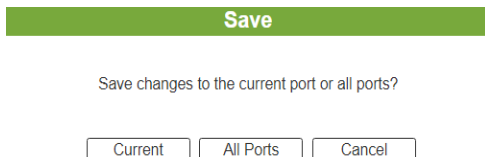

EDID & CEA Description

The right panel of the screen lets users view the configuration of the *EDID* and *CEA* Modes selected:

- ◆ From the left column, click the option that you want to view and/or edit. There are two categories: **EDID** (Extended Display Identification Data) and **CEA** (Consumer Electronics Association).
- ◆ When you highlight the menu items on the left column, the right column displays the current settings for the corresponding EDID configuration. Some of the screens are read-only.
- ◆ See *Customized EDID Settings*, page 56 for more information on these two columns.

Customized EDID Settings

The EDID structure is comprised of 128 bytes in total – each heading shown in the left column corresponds to a specific number of bytes.

The pages for the pre-configured EDID Modes (Port 1, Default, and Remix) cannot be edited. The pages for the Customized EDID, which can be edited, are discussed in the proceeding sections:

Established Timings

This page lists video resolutions/timings that display devices can support.

The screenshot shows the EDID configuration interface. On the left, under 'EDID Mode', 'Port 1 Customized' is selected. The main area is titled 'EDID & CEA Description' and contains a list of EDID sections. The 'Established Timings' section is highlighted with a red box and contains the following items:

Resolution/Refresh Rate	Checked
<input checked="" type="checkbox"/> 720x400 @ 70Hz	Yes
<input type="checkbox"/> 720x400 @ 88Hz	No
<input checked="" type="checkbox"/> 640x480 @ 60Hz	Yes
<input checked="" type="checkbox"/> 640x480 @ 67Hz	Yes
<input checked="" type="checkbox"/> 640x480 @ 72Hz	Yes
<input checked="" type="checkbox"/> 640x480 @ 75Hz	Yes
<input checked="" type="checkbox"/> 800x600 @ 56Hz	Yes
<input checked="" type="checkbox"/> 800x600 @ 60Hz	Yes
<input checked="" type="checkbox"/> 800x600 @ 72Hz	Yes
<input checked="" type="checkbox"/> 800x600 @ 75Hz	Yes
<input type="checkbox"/> 832x624 @ 75Hz (Apple Macintosh I)	No
<input type="checkbox"/> 1024x768 @ 87Hz, interlaced(1024*768i)	No
<input checked="" type="checkbox"/> 1024x768 @ 60Hz	Yes
<input checked="" type="checkbox"/> 1024x768 @ 70Hz	Yes
<input checked="" type="checkbox"/> 1024x768 @ 75Hz	Yes
<input checked="" type="checkbox"/> 1280x1024 @ 75Hz	Yes
<input type="checkbox"/> 1152x870 @ 75Hz(Apple Macintosh)	No

At the bottom of the list are 'Clear' and 'Select All' buttons. To the right of the interface, there are 'Retrieve EDID' and 'Save' buttons at the top, and a 'Tips' section with the following text:

- ATEN Default Mode**: All ports' EDID are the same as the hardware default EDID.
- Port1 Mode**: All ports' EDID are the same as Port1 EDID.
- Remix**: All ports' EDID use the lowest resolution display.
- Customized Mode**: The EDID Wizard is only enabled if the EDID is in "Customized Mode".

- ◆ Select the resolution(s) you want to use for the attached monitor/display device.
- ◆ Click **Clear** to deselect all the items.
- ◆ Click **Select All** to check all the items.
- ◆ Click **Save** to apply the changes.

Standard Timings

This page shows eight resolutions/timings that display devices can support in addition to those listed in the Established Timings page.

The screenshot shows the EDID configuration interface. On the left, the 'EDID Mode' is set to 'Port 1 Customized'. The main area is titled 'EDID & CEA Description' and contains a list of 10 EDID items. Item 6, 'Standard Timings', is expanded to show a table of supported resolutions and aspect ratios. The table is highlighted with a red box. The table has four columns: H Active Pixel, V Active Pixel, R Refresh Rate, and Aspect Ratio. The rows show various resolutions and their corresponding aspect ratios.

H Active Pixel	V Active Pixel	R Refresh Rate	Aspect Ratio
H 1600	V 1200	R 60	4:3
H 1280	V 1024	R 60	5:4
H 1400	V 1050	R 60	4:3
H 1440	V 900	R 60	16:10
H 1680	V 1050	R 60	16:10
H 1920	V 1080	R 60	16:9
H 1280	V 800	R 60	16:10
H 1920	V 1200	R 60	16:10

On the right side, there are 'Retrieve EDID' and 'Save' buttons, and a 'Tips' section with information about ATEN Default Mode, Port1 Mode, and Customized Mode.

- ◆ Select the *H Active Pixel* from the drop-down menu.
- ◆ Select the *Aspect Ratio* from the drop-down menu.
- ◆ Click **Save** to apply the changes.

Detail Timing / Display Description

This screen gives more video resolution options, and provides resolution/timing details.

The screenshot shows the EDID configuration interface with the 'Detail Timing / Display Description' section expanded. The 'Resolution:' dropdown menu is highlighted with a red box. Below it, the 'Resolution Detail' table is shown, which provides more granular information about the video resolution and timing parameters.

	Horizontal	Vertical
Image Size :	mm	mm
Active PXL :	pixel	lines
Blanking Time :	pixel	lines
Sync Offset :	pixel	lines
Sync Width :	pixel	lines
Border :	pixel	lines

Other details visible include 'Resolution: 1920x1200', 'Stereo Display Interfaced: Non-interfaced', and 'Sync type: Digital Separate'. The 'Tips' section on the right provides additional context about the EDID configuration.

In the drop down menu, choose a resolution with values that fit the attached monitor/display device and click **Save**.

Monitor Description

This screen lets you specify the viewing specifications, namely horizontal and vertical scan ranges and pixel clock rate, of your monitor/display device.

The screenshot shows the 'EDID & CEA Description' configuration window. On the left, the 'EDID Mode' is set to 'Customized'. The main area is divided into 'EDID' and 'CEA' sections. The 'EDID' section includes a list of 10 items, with '9. Monitor Description' selected. To the right of this list, a table allows for manual input of scan ranges and pixel clock rate. The values entered are: Horizontal Scan Range (15 to 135), Vertical Scan Range (23 to 121), and Pixel Clock Rate (600 MHz). A red box highlights this input area. On the far right, there are 'Tips' and 'Save'/'Retrieve EDID' buttons.

	Minutes	~	Max
Horizontal Scan Range:	15	~	135
Vertical Scan Range:	23	~	121
Pixel Clock Rate: (MHz)	600		(10-2550)

Enter the values that correspond to your device and click **Save** to apply the changes.

CEA Settings

CEA is an extension data of the EDID structure, which further extends the standard definitions of EDID to support advanced features of monitors/display devices.

Display Support

This screen describes the display's basic digital components.

EDID Mode	EDID & CEA Description	Retrieve EDID	Save
<ul style="list-style-type: none"> <input type="radio"/> ATEN Default <input type="radio"/> Port1 Mode <input type="radio"/> Remix <input checked="" type="radio"/> Customized <p style="text-align: center;">Apply</p> <p>Port EDID Status</p> <ul style="list-style-type: none"> <li style="background-color: #e0e0e0;">Port 1 Customized Port 2 Customized Port 3 Customized Port 4 Customized Port 5 Customized Port 6 Customized Port 7 Customized Port 8 Customized 	<p>EDID</p> <ol style="list-style-type: none"> 1. Vendor/Product Identification 2. EDID Structure/Revision 3. Basic Display/Feature 4. Color Characteristics 5. Established Timings 6. Standard Timings 7. Detail Timing/Display Description 1 8. Detail Timing/Display Description 2 9. Monitor Description 10. Monitor Description <p>CEA</p> <ol style="list-style-type: none"> 1. Display Support 2. Video Data 3. Audio Data 4. Speaker Allocation 5. Vendor Specific Data 	<p>Revision: 0x03</p> <p>Underscan: yes</p> <p>Basic Audio: yes</p> <p>YCbCr: <input checked="" type="checkbox"/> YCbCr444 <input checked="" type="checkbox"/> YCbCr422</p>	<p>Tips</p> <p>ATEN Default Mode</p> <p>All ports' EDID are the same as the hardware default EDID.</p> <p>Port1 Mode</p> <p>All ports' EDID are the same as Port1 EDID.</p> <p>Remix</p> <p>All ports' EDID use the lowest resolution display.</p> <p>Customized Mode</p> <p>The EDID Wizard is only enabled if the EDID is in "Customized Mode".</p>

Select the YCbCr mode applicable to your display and click **Save**.

Video Data

This screen lists additional video resolution/timing displays that may be supported by devices other than PC monitors (for example, 1080i).

The screenshot shows the EDID Wizard interface. On the left, the 'EDID Mode' panel has 'Customized' selected. The main panel, 'EDID & CEA Description', has 'Video Data' selected. A red box highlights the 'Resolution' list, which includes:

- Native: 1920 x 1080p @ 59.94/60Hz 16:9
- 640 x 480p @ 59.94/60Hz 4:3
- 720 x 480p @ 59.94/60Hz 4:3
- 720 x 480p @ 59.94/60Hz 16:9
- 1280 x 720p @ 59.94/60Hz 16:9
- 1920 x 1080i @ 59.94/60Hz 16:9
- 720(1440) x 480i @ 59.94/60Hz 4:3
- 720(1440) x 480i @ 59.94/60Hz 16:9
- 720(1440) x 240p @ 59.94/60Hz 4:3

 The 'Native' dropdown is also highlighted with a red box. Below the resolution list, the 'Data Block Size' is set to 20, and the 'YCBCR 4:2:0 Video Support' section is visible, showing options for 3840x2160p @ 50Hz 16:9, 3840x2160p @ 59.94Hz/60Hz 16:9, 4096x2160p @ 50Hz 256:135, and 4096x2160p @ 59.94Hz/60Hz 256:135. On the right, there are buttons for 'Retrieve EDID' and 'Save', and a 'Tips' section with text: 'All ports' EDID are the same as the hardware default EDID.', 'All ports' EDID are the same as Port1 EDID.', 'All ports' EDID use the lowest resolution display.', and 'The EDID Wizard is only enabled if the EDID is in "Customized Mode".'

- ◆ Select the native resolution of the attached display device.
- ◆ Select the resolutions that work with the attached monitor/display device.
- ◆ Click **Clear All** to deselect all the items.
- ◆ Click **Save** to apply the changes.

Audio Data

This screen lets you select advanced audio configurations for your device.

The screenshot shows the 'Audio Data' configuration screen. On the left, the 'EDID Mode' section has 'Customized' selected. The 'EDID & CEA Description' section lists 10 EDID items and 5 CEA items. The 'Audio Format 1' dropdown menu is highlighted with a red box and set to 'Linear PCM 2-channel'. The 'Tips' section on the right provides information about EDID settings for different modes.

Use the drop down menu to select the **Audio Format** (1~6) applicable to your audio output device, and click **Save** to apply the changes.

Detail Timing / Display Description

This screen gives more video resolution options, and provides resolution/timing details (in addition to those specified in the EDID structure).

The screenshot shows the 'Detail Timing / Display Description' configuration screen. The 'Resolution' dropdown menu is highlighted with a red box. The 'EDID & CEA Description' section lists 10 EDID items and 5 CEA items. The 'Resolution Detail' table provides timing information for the selected resolution.

	Horizontal	Vertical
Image Size :	mm	mm
Active PXL :	pixel	lines
Blanking Time :	pixel	lines
Sync Offset :	pixel	lines
Sync Width :	pixel	lines
Border :	pixel	lines

In the **Resolution** drop down menu, choose a resolution with values that fit the attached monitor/display device and click **Save**.

Maintenance

The *Maintenance* page lets users upgrade the VM0404HB / VM0808HB's firmware and back up or restore system settings. This is an Administrator only function.

Firmware upgrade

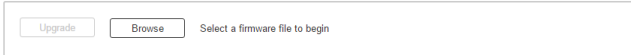

Upgrade Browse Select a firmware file to begin

Backup / Restore

*User accounts cannot be backed up or restored.



Backup

Restore Browse Select a restore file to begin

To upgrade the VM0404HB / VM0808HB's firmware, do the following:

1. Use the **Browse** button to locate the firmware upgrade file. Make sure you have the correct file saved on your PC.
2. Click **Upgrade** to begin the upgrade procedure.

Note: After updating the firmware, it's recommended that you clear your web browser's cache and then close and reopen the web browser. This will ensure the GUI refreshes and functions properly.

To back up the VM0404HB / VM0808HB's system settings, do the following:

1. Click **Backup**. A configuration file will then begin downloading.

To restore the VM0404HB / VM0808HB's system settings, do the following:

1. Use the **Browse** button to locate the configuration file. Make sure you have the correct file saved on your PC.
2. Click **Restore** to begin the restoration procedure.

Note: User accounts cannot be backed up or restored.

HDCP

The *HDCP* page lets users view and set HDCP key settings between input and output ports for digital copy protection and to ensure seamless switching between different devices. This is an Administrator and Advanced User only function.

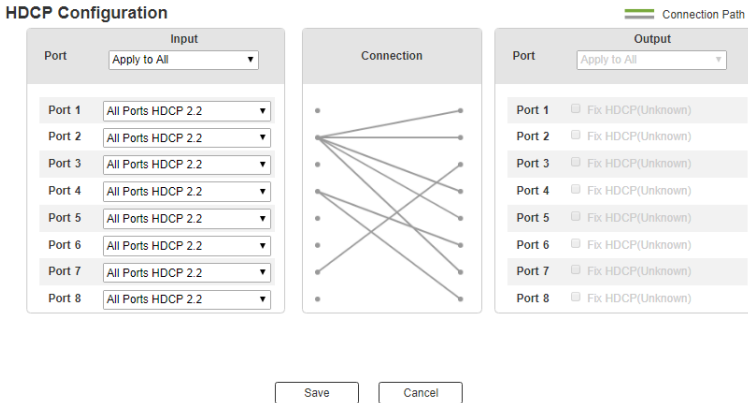

Input

Here users can select whether input port content is HDCP 2.2, HDCP 1.4, or non-HDCP enabled.

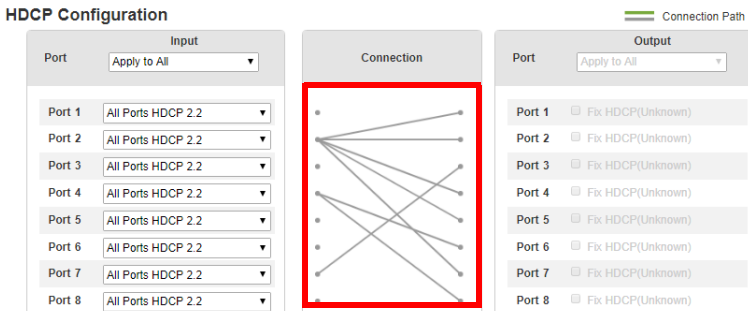

Connection

Here users can find a visual display of connection paths between inputs and outputs. When selecting an input, its path is displayed in green.

CEC

Consumer Electronics Control (CEC) allows interconnected HDMI devices to communicate and respond to one remote control.

CEC

Port	CEC
	Apply to All ▼
Port1	<input type="checkbox"/> OFF
Port2	<input checked="" type="checkbox"/> ON
Port3	<input type="checkbox"/> OFF
Port4	<input type="checkbox"/> OFF
Port5	<input type="checkbox"/> OFF
Port6	<input type="checkbox"/> OFF
Port7	<input type="checkbox"/> OFF
Port8	<input type="checkbox"/> OFF

* The CEC setting is only for output boards, please make sure all devices have this capability.

To set the CEC for each port, do the following:

- ◆ Use the drop-down menu to apply options to all ports, or
- ◆ Use the On/Off buttons to enable/disable CEC for individual ports.

Chapter 5

CLI Commands

Overview

The VM0404HB / VM0808HB can be configured and controlled via RS-232 or Telnet commands when connected to a host computer or other device, such as a control system. This chapter provides information on how to connect to the VM0404HB / VM0808HB via RS-232/Telnet and command syntax.

Connecting to the Matrix Switch via Telnet

To establish a Telnet session with the VM0404HB / VM0808HB, do the following:

1. Connect a host computer or control system to a shared network with the VM0404HB / VM0808HB.
2. Open a command-line interpreter program from your computer.
3. In the command-line interpreter, type the VM0404HB / VM0808HB's IP address in the following way:

```
telnet [IP address]:23
```
4. Press **Enter**. The login screen appears.
5. At the login prompt, type the login username and password for the VM0404HB / VM0808HB.
6. When a session is established with the VM0404HB / VM0808HB, you can control and configure the VM0404HB / VM0808HB via RS-232 commands. For more information on commands, see *Commands*, page 67

Note: If a user logs in using a username that is already in session, the newest login takes effect and the previous session will be replaced.

Connecting to the Matrix Switch via RS-232

You can control and operate the VM0404HB / VM0808HB using a high-end controller or PC. To connect to the VM0404HB / VM0808HB via RS-232, do the following:

1. Connect the RS-232 serial port on the VM0404HB / VM0808HB to the RS-232 serial port on your computer using a 9-wire straight cable, with only pin 2 to pin 2, pin 3 to pin 3, and pin 5 to pin 5 connected.

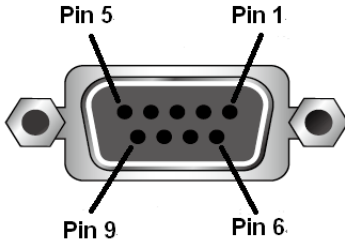

Pin	Description
1	Not connected
2	RxD
3	TxD
4	Not connected
5	GND
6	Not connected
7	Not connected
8	Not connected
9	Not connected

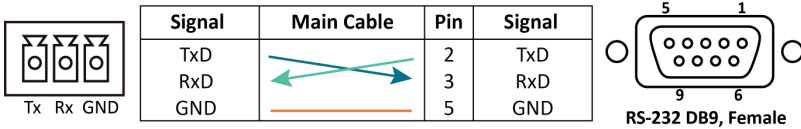

2. The controller's serial port should be configured as follows:

RS-232 Protocol	
Baud Rate	19200
Data Bits	8
Parity	None
Stop Bits	1
Flow Control	None

When a session is established with the VM0404HB / VM0808HB, you can control and configure the VM0404HB / VM0808HB via RS-232 commands. For more information on commands, see *Commands*, page 67.

Command Verification

After entering a command, a verification message appears at the end of the command line as follows:

- ◆ **Command OK** - indicates that the command is correct and successfully performed by the switch
- ◆ **Command incorrect** - indicates that the command has the wrong format and/or values.

Commands

After connecting to the VM0404HB / VM0808HB via Telnet or RS-232, you can operate the system using the following commands.

Switch Port Command

The Switch Port command allows you to switch ports on the VM0404HB / VM0808HB.

The formula for the Switch command is as follows:

Command + Input + Number + Output + Number + Control + [Enter]

1. For example, to switch input port 02 to output port 05, type:
sw i02 o05 [Enter]
2. To switch output port 04 to the next port, type:
sw o04 + [Enter]
3. To turn off video output on port 03, type:
sw o03 off [Enter]

The following tables show the possible values for the **Switch Port** command:

Command	Description
sw	Switch command

Input Command	Description
i	Input command

Port number	Description
xx	VM0404HB: 01~04
	VM0808HB: 01~08

Output Command	Description
o	Output command

Port number	Description
yy	VM0404HB: 01~04 VM0808HB: 01~08
*	All output ports

Control	Description
on	Turn on the display
off	Turn off the display
+	Next Port
-	Previous Port

- Note:**
1. By default, input port 01 is tied to output port 01; input port 02 is tied to output port 02; and so on until port 08 (i.e., o01 i01, o02 i02).
 2. Each command string should be separated with a space.
 3. The **Port Number** can be skipped, and the default value will be used.

The following table lists the available Switch Port commands:

Command	Input Command	Input Port	Output Command	Output Port	Control	Enter	Description
sw	i	xx	o	yy *		[Enter]	Switch Input Port xx to Output Port yy (xx:01~04 or 01~08; yy:01~04 or 01~08, *)
sw			o	yy *	on off	[Enter]	Turn on Output Port yy Turn off Output Port yy (yy:01~04 or 01~08, *)
sw			o	yy *	+ -	[Enter]	Switch Output port yy to next Output port. Switch Output port yy to previous Output port. (yy:01~04 or 01~08, *)

EDID Command

Extended Display Identification Data (EDID) is a data that contains a display's basic information and is used to communicate with the video source.

The formula for the EDID command is as follows:

Command + Input + Number + Control + [Enter]

- For example, to apply the EDID setting of the display connected to output port1, and pass it to the video source connected to input port2, type:

edid i02 port1 [Enter]

The following tables show the possible values for the **EDID** command:

Command	Description
edid	EDID command
Input Command	Description
i	Input port
Port number	Description
xx	VM0404HB: 01~04
	VM0808HB: 01~08
*	All input ports
Control	Description
portyy	Implement the EDID of the connected display to output port yy, and pass it to the video source. (yy: 01~04 or 01~08)
remix	Implement the EDID of all connected displays. The VM0404HB / VM0808HB uses the best resolution for all displays.
defaultyy	Implements one of the 18 ATEN default EDID configuration. (yy: 00~17, default is 00)

Note: Each command string should be separated with a space.

The following table lists the available EDID commands:

Command	Input	Number	Control	Enter	Description
edid			portyy (yy: 01~04 or 01~08)	[Enter]	Copy the EDID from output port yy and pass it to all video sources.
edid	i	xx (xx: 01~04 or 01~08, *)	portyy (yy: 01~04 or 01~08)	[Enter]	Copy the EDID from output port yy and pass it to the video source of input port xx.
edid			defaultyy (yy: 00~17)	[Enter]	Implements one of the 18 ATEN default EDID configuration to all video sources.
edid	i	xx (xx: 01~04 or 01~08, *)	defaultyy (yy: 00~17)	[Enter]	Implements one of the 18 ATEN default EDID configuration to the video source of input port xx.
edit			remix	[Enter]	Implement the EDID of all connected displays. The VM0404HB / VM0808HB uses the best resolution for all displays.

The following table lists the 18 ATEN default EDID configurations that can be selected via the RS-232 command line:

Default EDID No.	Configuration	Remark
00	4K2K video, 2 ch audio (default)	
01	1080p video, 2 ch audio	
02	1080p video, 5.1 ch audio	
03	1080p video, 7.1 ch audio	
04	1080i video, 2 ch audio	
05	1080i video, 5.1 ch audio	
06	1080i video, 7.1 ch audio	
07	3D 1080p, 2 ch audio	
08	3D 1080p, 5.1 ch audio	
09	3D 1080p, 7.1 ch audio	
10	1024 x 768 DVI format	DVI mode
11	1280 x 1024 DVI format	DVI mode
12	1920 x 1080 DVI format	DVI mode
13	1920 x 1200 DVI format	DVI mode
14	3840x2160 @ 30 7.1ch audio	
15	3840x2160 @ 60 7.1ch audio	
16	4096x2160 @ 30 7.1ch audio	
17	4096x2160 @ 60 7.1ch audio	

Mute Command

Mute allows you to disable or enable audio for one or all output ports.

The formula for the Mute command is as follows:

Command + Output + Number + Control + [Enter]

- For example, to mute the audio coming from output port 1, type:
mute o01 on [enter]

The following tables show the possible values for the **Mute** command:

Command	Description
mute	Mute command
Output Command	Description
o	Output command
Port number	Description
yy	VM0404HB: 01~04 (default is 01) VM0808HB: 01~08 (default is 01)
*	All output ports
Control	Description
on	Mute on; audio output is disabled
off	Mute off; audio output is enabled (default)

Note: 1. Each command string should be separated with a space.

- Skip the output port command to mute or enable the audio of all output ports.

The following table lists the available Mute commands:

Command	Output Command	Output Port	Control	Enter	Description
mute	o	yy *	on	[Enter]	Audio on for output port yy (yy:01~04 or 01~08, *)
mute	o	yy *	off	[Enter]	Audio off for output port yy (default) (yy:01~04 or 01~08, *)

CEC Command

Consumer Electronics Control (CEC) allows interconnected HDMI devices to communicate and respond to the same remote control.

The formula for the CEC command is as follows:

Command + Output + Number + Control + [Enter]

1. For example, to enable the CEC function on output port 1, type:
cec o01 on [enter]

The following tables show the possible values for the CEC command:

Command	Description
cec	CEC command
Output Command	Description
o	Output command
Port number	Description
yy	VM0404HB: 01~04 (default is 01) VM0808HB: 01~08 (default is 01)
*	All output ports
Control	Description
off	Disable CEC (default)
on	Enable CEC

Note: Each command string should be separated with a space.

The following table lists the available CEC commands:

Command	Output Port	Control	Enter	Description
cec	yy *	off	[Enter]	CEC off for output port yy (default) (yy:01~04 or 01~08, *)
cec	yy *	on	[Enter]	CEC on for output port yy (yy:01~04 or 01~08, *)

Echo Command

The Echo function updates the RS232 controller when operations are made via the front panel pushbuttons, web browser, or telnet. The changes echo back to the RS232 controller to keep the settings in sync with the device.

The formula for the Echo command is as follows:

Command + Control + [Enter]

1. For example, to enable the echo feature, type:

echo on [Enter]

The following tables show the possible values for the **Echo** command:

Command	Description
echo	Echo command

Control	Description
on	Turns Echo function on
off	Turns Echo function off (default)

Note: Each command string should be separated with a space.

The following table lists the available Echo commands:

Command	Control	Enter	Description
echo	on	[Enter]	Turn on Echo function
echo	off	[Enter]	Turn off Echo function

Black Screen Command

The Black Screen command turns a display screen black when no source signal is detected. This prevents the display from showing the default blue or other color used when no source signal is detected.

The formula for the Black Screen command is as follows:

Command + Control + [Enter]

1. For example, to enable the Black Screen function, type:

blackscreen on [Enter]

The following tables show the possible values for the **Black Screen** command:

Command	Description
blackscreen	Black Screen command

Control	Description
on	Turns Black Screen function on (default)
off	Turns Black Screen function off

Note: Each command string should be separated with a space.

The following table lists the available Black Screen commands:

Command	Control	Enter	Description
blackscreen	on	[Enter]	Turn on Black Screen function
blackscreen	off	[Enter]	Turn off Black Screen function

Read Command

The Read command allows you to view the current configuration, firmware and other information about the device.

The formula for the Read command is as follows:

Command + [Enter]

1. To view information about the device, type:

read [Enter]

Note: Each command string should be separated with a space.

The following table lists the available Read commands:

Command	Enter	Description
read	[Enter]	View information about the device, including the input/output connections, audio/video and CEC status, EDID settings and the firmware version

Reset Command

The Reset command allows you to reset the VM0404HB / VM0808HB to the default factory settings.

The formula for the Reset command is as follows:

Command + [Enter]

Note: Each command string should be separated with a space.

The following table lists the available Reset commands:

Command	Enter	Description
reset	[Enter]	Resets the device settings

Baud Rate Command

The Baud Rate command allows you to set the RS-232 data rate for the VM0404HB / VM0808HB to use. Options are 9600, 19200 (default), 38400, and 115200.

The formula for the Baud Rate command is as follows:

Command + Control + [Enter]

1. For example, to set 38400 as the baud rate, type:

baud 38400 [Enter]

The following tables show the possible values for the **Baud Rate** command:

Command	Description
baud	Sets the RS-232 baud rate

Control	Description
9600	Use 9600 baud rate
19200	Use 19200 baud rate (default)
38400	Use 38400 baud rate
115200	Use 115200 baud rate

Note: Each command string should be separated with a space.

The following table lists the available Baud Rate commands:

Command	Control	Enter	Description
baud	9600 / 19200 / 38400 / 115200	[Enter]	Sets the RS-232 baud rate

Save/Load Profile Command

The Save/Load Profile command allows you to save and load connection profiles. Saving profiles will save the connections currently in use.

The formula for the Save/Load Profile command is as follows:

Command + Profile + Number + Control + [Enter]

1. For example, to save the current connection configuration to profile 02, type:

profile f 02 save [Enter]

2. To load profile 12, type the following:

profile f 12 load [Enter]

The following tables show the possible values for the **Save/Load Profile** commands:

Command	Description
profile	Save / Load profile
Profile	Description
f	Profile command
Profile Number	Description
yy	VM0404HB: 01~08 (default is 01)
	VM0808HB: 01~16 (default is 01)
Control	Description
save	Save the connection configuration
load	Load a saved profile

Note: Each command string should be separated with a space.

The following table lists the available Save/Load Profile commands:

Command	Profile	Profile Number	Control	Enter	Description
profile	f	yy (yy:01~08 or 01~16)	save	[Enter]	Save the connections as profile yy.
profile	f	yy (yy:01~08 or 01~16)	load	[Enter]	Load profile yy.

Power on Detection Command

Power on Detection command allows you to enable or disable the Power on Detection function for the **VM0808HB**.

The formula for the Power on Detection command is as follows:

Command + Control + [Enter]

1. For example, to enable the Power on Detection function, type:
pod on [Enter]

The following tables show the possible values for the **Power on Detection** command:

Command	Description
pod	Power on Detection command

Control	Description
on	Enable the Power on Detection
off	Disable the Power on Detection

Note: Each command string should be separated with a space.

The following table lists the available Power on Detection commands:

Command	Control	Enter	Description
pod	on	[Enter]	Enable the Power on Detection
pod	off	[Enter]	Disable the Power on Detection

Safety Instructions

General

- ◆ Read all of these instructions. Save them for future reference.
- ◆ Follow all warnings and instructions marked on the device.
- ◆ This product is for indoor use only.
- ◆ Do not place the device on any unstable surface (cart, stand, table, etc.). If the device falls, serious damage will result.
- ◆ Do not use the device near water.
- ◆ Do not place the device near, or over, radiators or heat registers.
- ◆ The device cabinet is provided with slots and openings to allow for adequate ventilation. To ensure reliable operation, and to protect against overheating, these openings must never be blocked or covered.
- ◆ The device should never be placed on a soft surface (bed, sofa, rug, etc.) as this will block its ventilation openings. Likewise, the device should not be placed in a built in enclosure unless adequate ventilation has been provided.
- ◆ Never spill liquid of any kind on the device.
- ◆ Unplug the device from the wall outlet before cleaning. Do not use liquid or aerosol cleaners. Use a damp cloth for cleaning.
- ◆ The device should be operated from the type of power source indicated on the marking label. If you are not sure of the type of power available, consult your dealer or local power company.
- ◆ The device is designed for IT power distribution systems with 230V phase-to-phase voltage.
- ◆ To prevent damage to your installation it is important that all devices are properly grounded.
- ◆ The device is equipped with a 3-wire grounding type plug. This is a safety feature. If you are unable to insert the plug into the outlet, contact your electrician to replace your obsolete outlet. Do not attempt to defeat the purpose of the grounding-type plug. Always follow your local/national wiring codes.
- ◆ Do not allow anything to rest on the power cord or cables. Route the power cord and cables so that they cannot be stepped on or tripped over.

- ◆ If an extension cord is used with this device make sure that the total of the ampere ratings of all products used on this cord does not exceed the extension cord ampere rating. Make sure that the total of all products plugged into the wall outlet does not exceed 15 amperes.
- ◆ To help protect your system from sudden, transient increases and decreases in electrical power, use a surge suppressor, line conditioner, or un-interruptible power supply (UPS).
- ◆ Position system cables and power cables carefully; Be sure that nothing rests on any cables.
- ◆ Never push objects of any kind into or through cabinet slots. They may touch dangerous voltage points or short out parts resulting in a risk of fire or electrical shock.
- ◆ Do not attempt to service the device yourself. Refer all servicing to qualified service personnel.
- ◆ If the following conditions occur, unplug the device from the wall outlet and bring it to qualified service personnel for repair.
 - ◆ The power cord or plug has become damaged or frayed.
 - ◆ Liquid has been spilled into the device.
 - ◆ The device has been exposed to rain or water.
 - ◆ The device has been dropped, or the cabinet has been damaged.
 - ◆ The device exhibits a distinct change in performance, indicating a need for service.
 - ◆ The device does not operate normally when the operating instructions are followed.
- ◆ Only adjust those controls that are covered in the operating instructions. Improper adjustment of other controls may result in damage that will require extensive work by a qualified technician to repair.
- ◆ Avoid circuit overloads. Before connecting equipment to a circuit, know the power supply's limit and never exceed it. Always review the electrical specifications of a circuit to ensure that you are not creating a dangerous condition or that one does not already exist. Circuit overloads can cause a fire and destroy equipment.

Rack Mounting

- ◆ Before working on the rack, make sure that the stabilizers are secured to the rack, extended to the floor, and that the full weight of the rack rests on the floor. Install front and side stabilizers on a single rack or front stabilizers for joined multiple racks before working on the rack.
- ◆ Always load the rack from the bottom up, and load the heaviest item in the rack first.
- ◆ Make sure that the rack is level and stable before extending a device from the rack.
- ◆ Do not overload the AC supply branch circuit that provides power to the rack. The total rack load should not exceed 80 percent of the branch circuit rating.
- ◆ Make sure that all equipment used on the rack – including power strips and other electrical connectors – is properly grounded.
- ◆ Ensure that proper airflow is provided to devices in the rack.
- ◆ Ensure that the operating ambient temperature of the rack environment does not exceed the maximum ambient temperature specified for the equipment by the manufacturer.
- ◆ Do not step on or stand on any device when servicing other devices in a rack.

Specifications

Function		VM0404HB	VM0808HB
Video Input	Interface	4 x HDMI Type A Female (Black)	8 x HDMI Type A Female (Black)
	Impedance	100 Ω	
	Max. Distance	5m / 4K@60Hz (4:4:4)	
Video Output	Interface	4 x HDMI Type A Female (Black)	8 x HDMI Type A Female (Black)
	Impedance	100 Ω	
	Max. Distance	5m / 4K@60Hz (4:4:4); 15m / 1920 x 1200	
Video	Max. Data Rate	18 Gbps (6 Gbps Per Lane)	
	Max. Pixel Clock	600 MHz	
	Compliance	HDMI (3D, 4K, Deep Color) HDCP 2.2 Compatible Consumer Electronics Control (CEC)	
	Max. Resolution	Up to 4096 x 2160 / 3840 x 2160 @ 60Hz (4:4:4)	
Control	RS-232	Connector: 1 x DB-9 Female (Black) Baud rate and protocol: Baud Rate: 19200, Data Bits: 8, Stop Bits:1, Parity: No, Flow Control: No	
	IR	1 x Mini Stereo Jack Female (Black)	
	Ethernet	1 x RJ-45 Female	
EDID Settings		EDID Mode: Default / Port 1 / Remix / Customized (EDID Wizard Support)	
Power	Connector	1 x 3-Prong AC Socket	
	I/P Rating	100-240VAC; 50-60Hz; 1.0A	
	Consumption	AC110: 17.8W:83BTU; AC220:17.6W:83BTU	AC110: 38.1W:179BTU; AC220:37.8W:177BTU
Environment	Operating Temp.	0–40°C	
	Storage Temp.	-20–60°C	
	Humidity	0–80% RH, Non-condensing	
Physical Properties	Housing	Metal	
	Weight	2.47 kg (5.44 lb)	3.99 kg (8.79 lb)
	Dimensions (L x W x H)	43.72 x 16.28 x 4.40 cm (17.21 x 6.03 x 1.73 in)	43.24 x 26.23 x 4.40 cm (17.02 x 10.33 x 1.73 in)
Carton Lot		1 pc	

Telnet Operation

To connect to VM0404HB / VM0808HB via Telnet, follow the steps in *Connecting to the Matrix Switch via Telnet*, page 65.

Configuration Menu

Once a Telnet connection to the VM0404HB / VM0808HB is established, the device's text-based Configuration Menu comes up, with the following items:

1. H – Call up the command list for help

Command list:

IP – Set IP address

LO – Load connections from profile *nn*

PW – Change password

RI – Read what input is connected to *nn* output

RO – Read what output is connected to *nn* input

SB – Set the serial port baud rate

SS – Switch input to specified port

SV – Save the current connections into profile *nn*

TI – Set timeout

VR – Software version information

Ctrl-Q – Quit

2. IP – Set network settings

◆ Set IP Address

IP

Old IP Address: 192.168.0.60

Old IP Subnet Mask: 255.255.255.0

Old Gateway Address: 192.168.0.1

New IP Address:

◆ **Set Subnet Mask**

IP

Old IP Address: 192.168.0.60

Old IP Subnet Mask: 255.255.255.0

Old Gateway Address: 192.168.0.1

New IP Address: 10.3.52.220

New IP Subnet Mask:

◆ **Set Gateway Address**

IP

Old IP Address: 192.168.0.60

Old IP Subnet Mask: 255.255.255.0

Old Gateway Address: 192.168.0.1

New IP Address: 10.3.52.220

New IP Subnet Mask: 255.255.254.0

New Gateway Address:

Note: After the New IP Address, Subnet Mask, and Gateway Address are entered, the Video Matrix Switch will automatically reboot to apply the new network settings.

3. LO – Load connections from profile

LO 01

Load profile 01 OK.

4. PW – Change password

PW

Old password: *****

New password:

5. RI – Read what input is connected to *nn* output

RI 01

Input port 02 04 is connected to output port 01

6. RO – Read what output is connected to *nn* input

RO 01

Output port 02 is connected to input port 01

7. SB – Set serial port baud rate

SB 96

Serial port baud rate is set to 9600

8. SS – Switch input to specified output

SS 01, 03

Switch input 01 to output 03

9. SV – Save the current connections into a profile

SV 01

Save the current connections into profile 01

10. TI – Set timeout

TI 30

Set 30 minute timeout

11. VR – Software version information

VR

Software version 1.0.

Technical Support

International

- ◆ For online technical support – including troubleshooting, documentation, and software updates: <http://eservice.aten.com>
- ◆ For telephone support, see *Telephone Support*, page iv:

North America

Email Support		support@aten-usa.com
Online Technical Support	Troubleshooting Documentation Software Updates	http://www.aten-usa.com/support
Telephone Support		1-888-999-ATEN ext 4988

When you contact us, please have the following information ready beforehand:

- ◆ Product model number, serial number, and date of purchase.
- ◆ Your computer configuration, including operating system, revision level, expansion cards, and software.
- ◆ Any error messages displayed at the time the error occurred.
- ◆ The sequence of operations that led up to the error.
- ◆ Any other information you feel may be of help.

ATEN Standard Warranty Policy

Limited Hardware Warranty

ATEN warrants its hardware in the country of purchase against flaws in materials and workmanship for a Warranty Period of two [2] years (warranty period may vary in certain regions/countries) commencing on the date of original purchase. This warranty period includes the [LCD panel of ATEN LCD KVM switches](#). For UPS products, the device warranty is two [2] years but battery is one [1] year. Select products are warranted for an additional year (see [A+ Warranty](#) for further details). Cables and accessories are not covered by the Standard Warranty.

What is covered by the Limited Hardware Warranty

ATEN will provide a repair service, without charge, during the Warranty Period. If a product is defective, ATEN will, at its discretion, have the option to (1) repair said product with new or repaired components, or (2) replace the entire product with an identical product or with a similar product which fulfills the same function as the defective product. Replaced products assume the warranty of the original product for the remaining period or a period of 90 days, whichever is longer. When the products or components are replaced, the replacing articles shall become customer property and the replaced articles shall become the property of ATEN.

To learn more about our warranty policies, please visit our website:
<http://www.aten.com/global/en/legal/policies/warranty-policy/>

© Copyright 2023 ATEN® International Co., Ltd.
Released: 2023-03-23

ATEN and the ATEN logo are registered trademarks of ATEN International Co., Ltd. All rights reserved. All other brand names and trademarks are the registered property of their respective owners.