

Quick Start Guide

SC800

Version: 1.1

Overview

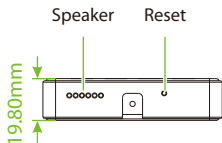
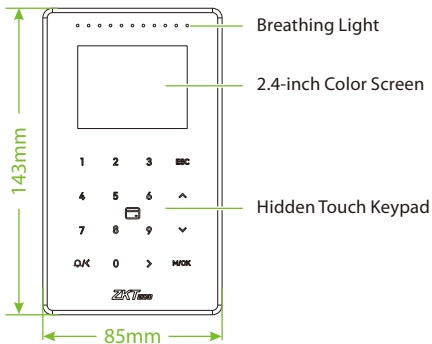

Terminal Block

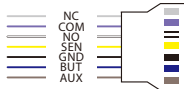
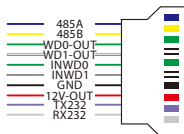
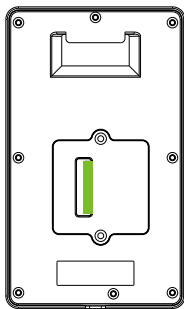

Installation Environment

Please refer to the following recommendations for installation.



KEEP DISTANCE



AVOID GLASS
REFRACTION



AVOID DIRECT
SUNLIGHT
AND EXPOSURE



AVOID USE OF
ANY HEAT SOURCE
NEAR THE DEVICE

Device Installation

- 1 Stick the mounting template sticker to the wall and drill holes according to the mounting template sticker.
- 2 Fix the backplate on the wall using wall mounting screws.
- 3 Place the device to the backplate.
- 4 Mount the device to the backplate with the security screws.

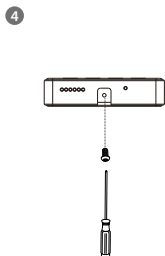
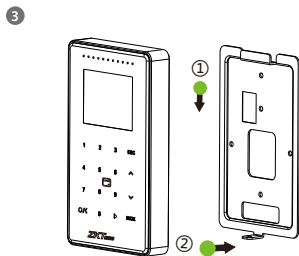
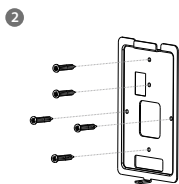
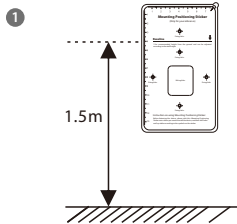

Standalone Installation

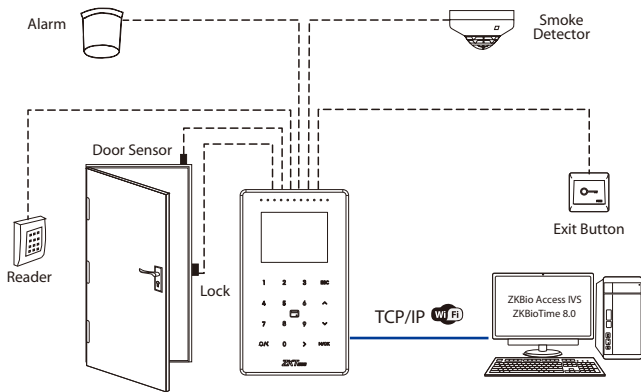

Power Connection

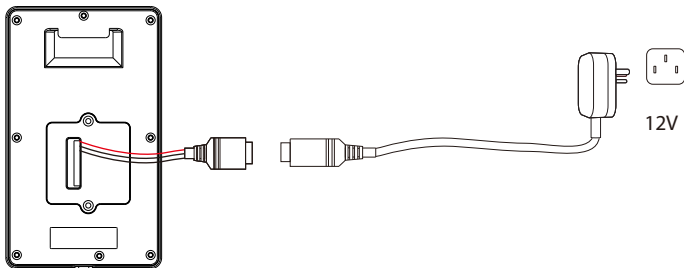

Recommended AC Adapter

- 1) 12V \pm 10%, at least 3A.
- 2) To share the power with other devices, use an AC Adapter with higher current ratings.

Ethernet Connection

Connect the device and computer over an Ethernet cable as shown in the figure:

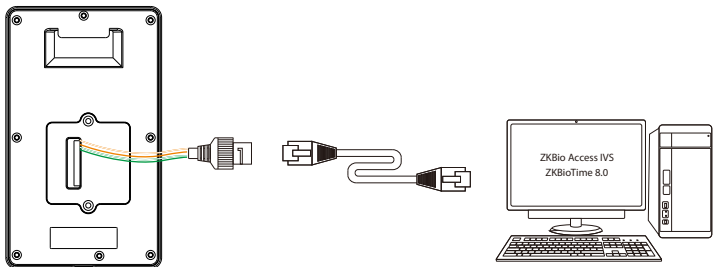

Default IP address: 192.168.1.201
Subnet mask: 255.255.255.0

IP address: 192.168.1.130
Subnet mask: 255.255.255.0

Tap on [COMM.] > [Ethernet] > [IP Address] , then enter the IP address and tap on [OK].

Note: In LAN, the IP addresses of the server (PC) and the device must be in the same network segment when connecting to the software.

Wiegand Reader Connection

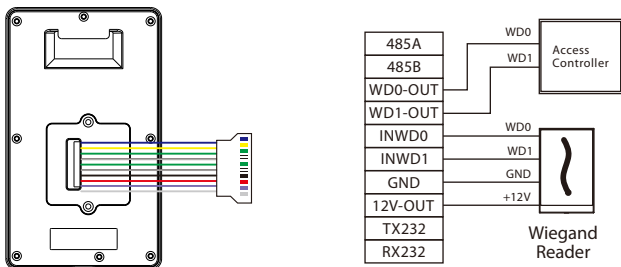

Note: 485A and 485B can be connected to the Barrier gate or the 485 Reader, separately, but cannot be connected to the gate and reader at the same time.

RS485 Connection

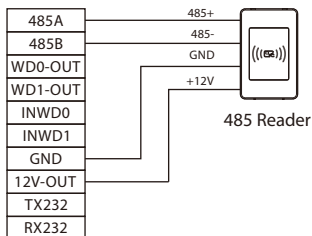
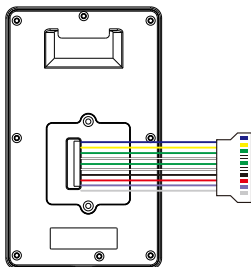

Door Sensor, Exit Button, Alarm & Auxiliary Connection

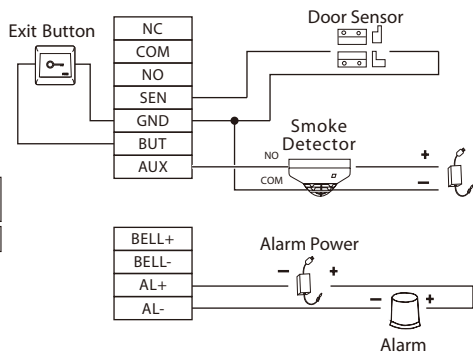
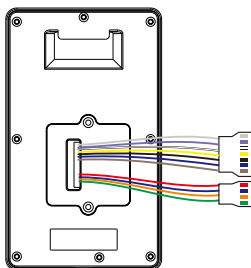

Lock Relay Connection

The system supports **Normally Opened Lock** and **Normally Closed Lock**. The **NO LOCK** (normally unlocked when power ON) is connected to 'NO' and 'COM' terminals, and the **NC LOCK** (normally locked when power ON) is connected to 'NC' and 'COM' terminals. Consider the following NC Lock as an example:

1) Device not sharing power with the lock

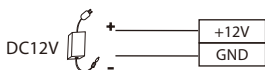

 Do not reverse the polarity.

Normally Closed Lock

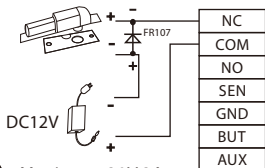

 Maximum 30V 3A input.

2) Device sharing power with the lock

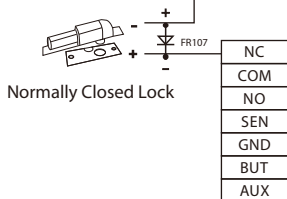

RS232 Connection

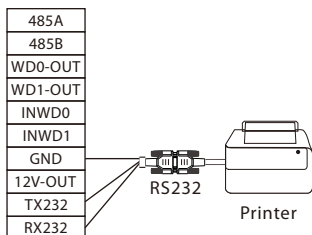
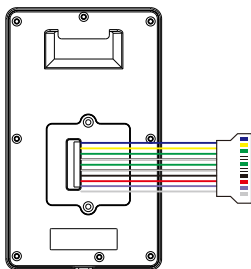

New User Registration

Tap on the [M/OK] key to enter the main menu if the device is not set up with a super administrator. Create a new user and set the User Role to Super Admin, then the system requests for the administrator's verification before entering the menu. It is recommended to register a super administrator initially for security purposes.

Method 1: Registering on the Device:

Tap on [M/OK] > [User Mgt.] > [New User] to register a new user. There are several options available, including entering the user ID, setting the user role and access control role, and registering the card number and password.

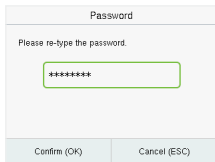
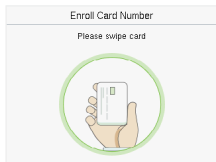
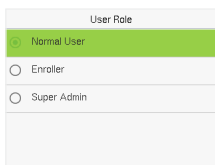
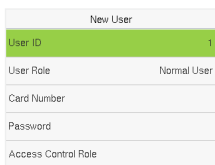
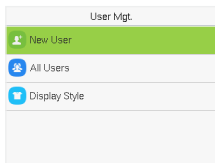

Method 2: Register on ZKBio Access IVS software:

Please set the IP address and cloud service server address in the Comm. Menu option on the device.

1. Click **[Attendance]** > **[Attendance Device]** > **[Device]** > **[Search Device]** to search the device on the software. Set the relevant server address and port on the device, and the searched devices will be displayed automatically.

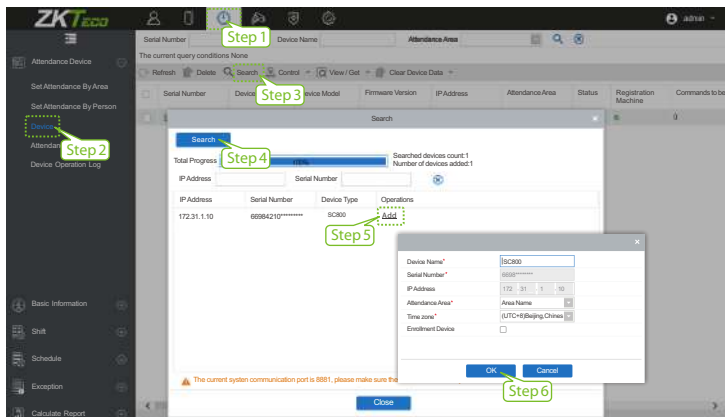

2. Click **[Add]** in the operation column, a new window will appear. Select Attendance Area and Time zone from each drop-downs and click **[OK]** to add the status.
3. Click **[Personnel]** > **[Person]** > **[New]** and fill in all the required fields to register a new user in the software.
4. Click **[Attendance Device]** > **[Device]** > **[Control]** > **[Synchronize Software Data to the Device]** to synchronize all the data to the device including the new users.

For more details, please refer to the *ZKBio Access IVS User Manual*.

Method 3: Register on the phone:

Once the ZKBio Access IVS software is installed, the users could enroll their face via a browser application on their own mobile phone.

1. Click **[Personnel]** > **[Parameters]**, enter “http://Server address: Port” in the QR Code URL bar. The software will automatically generate a QR code. Scan the QR code or login onto “http://Server address: Port/app/v1/adreg” by the mobile phone to register users.

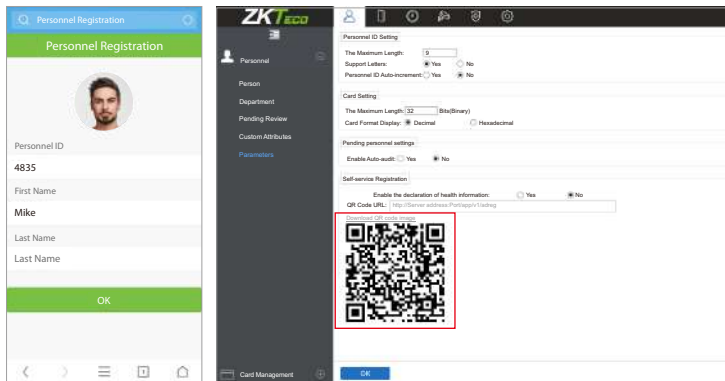

2. The users will be displayed in **[Personnel]** > **[Pending Review]**. Click the **[Review]** option and assign a department, then click **[OK]** to successfully add the user.

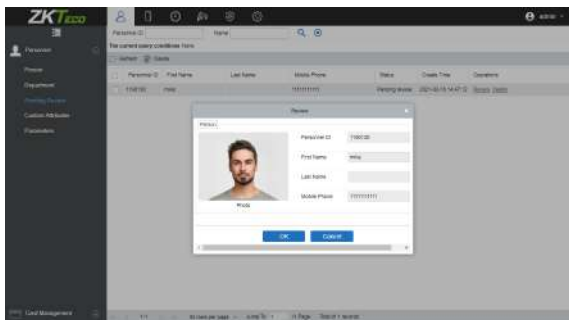

Ethernet and Cloud Server Settings

Tap on [M/OK] > [COMM.] > [Ethernet] to set the network parameters. If the TCP/IP communication of the device is successful, the icon  will be displayed in the upper right corner of the standby interface.

Tap on [M/OK] > [COMM.] > [Cloud Server Settings] to set the server address and server port, example, the IP address and port number of the server after the software is installed. If the device communicates with the server successfully, the icon  will be displayed in the upper right corner of the standby interface.

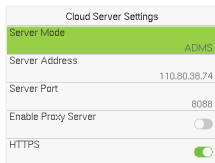
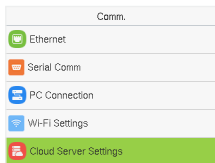
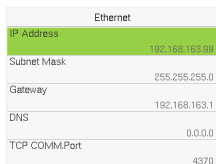
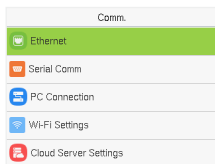
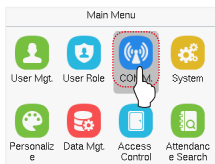

Note:

While pairing the device with ZKBio Access IVS / ZKBioTime8.0 software.

Server Address: Set as the IP address of the ZKBio Access IVS / ZKBioTime8.0 server.

Server Port: Set as the service port of ZKBio Access IVS / ZKBioTime8.0.

Access Control

Tap on [M/OK] > [Access Control] to enter the access control interface and set relevant parameters of access control.

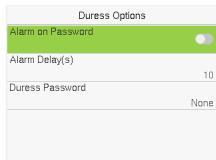
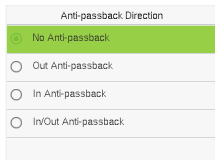
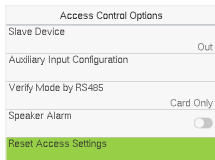
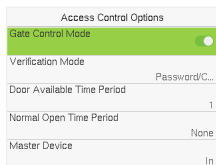
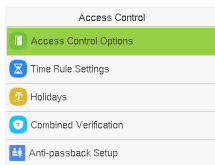

Attendance Search

Tap [M/OK] > [Attendance Search] to enter the Personal Record Search, then enter the user ID and time range to view the corresponding attendance record.

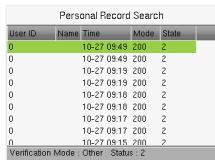
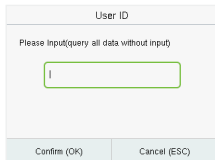
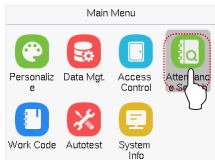

Device Type Settings

Tap on [M/OK] > [System] > [Device Type Settings] > [Device Type] to configure the device type settings.

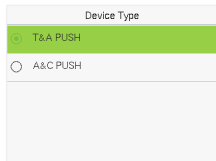
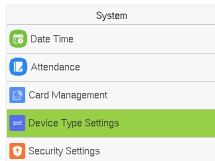
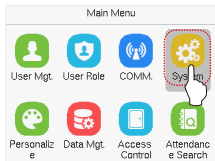

Card Management

The device supports multi-card management function. Tap on [M/OK] > [System] > [Card Management] to select required card type.

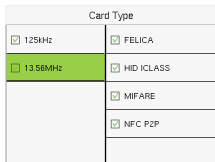
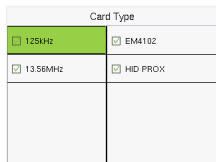
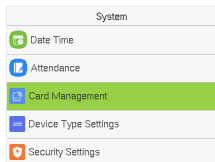
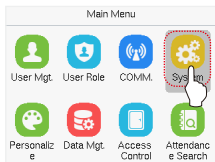

Login WebServer

The configured network login allows the Webserver can remotely view the information of the device (hardware, software, capacity, and data, etc.), set up the system (communication, access control, and system functions, etc.), add users and upgrade the system.

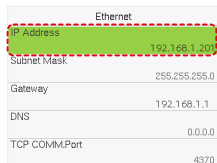
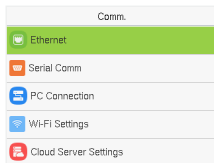
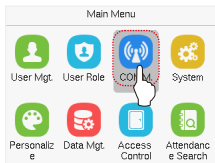

1. Open a browser and enter the address [https:// Serial IP Address:1443](https://Serial IP Address:1443) to log in to the WebServer, for example: <https://192.168.1.201:1443>.

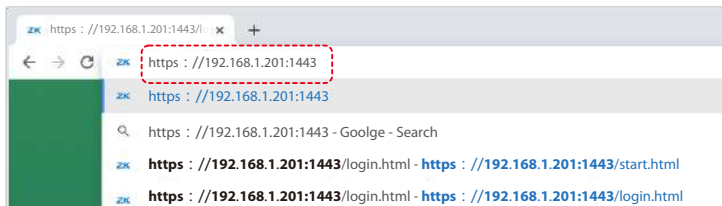

2. Enter the user name and password, the default user name is: **admin**, password: **admin@123**.

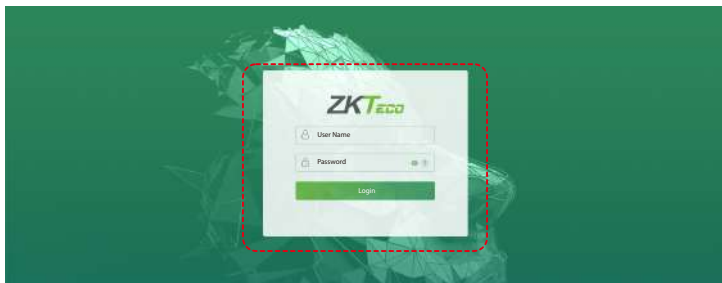

Note:

1. After log in for the first time, users must reset their original password and log in again before they can use it.
2. To retrieve the password easily, please register a super admin first.

Forgot Password

Method 1 (When there is a super admin):

If you forgot the password of WebServer, the registered super admin can reset it for you.

1. Click the icon on the login interface.

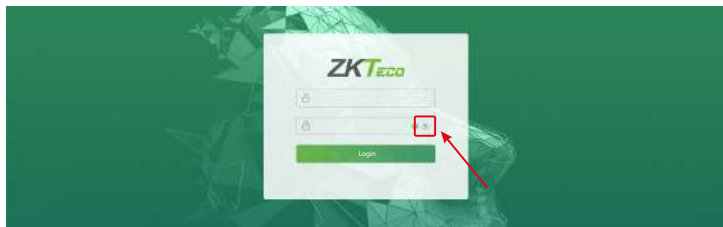

2. On the pop-up page, enter the relevant information of the super admin user as prompted.

Admin verification

Please input admin user ID: **Enter super admin user id**

Password: **Enter super admin user password**

3. After a successful reset, enter the default account and password (account: **admin**, password: **admin@123**) on the login interface to log in.

Method 2 (When there is no super admin):

If the network of the device is normal and ZKBio Access IVS / ZKBioTime 8.0 has been connected, you can reset the password by sending the super admin account and password from the server.

1. Click **[Personnel]** > **[Person]** > **[New]** on the ZKBio Access IVS / ZKBioTime 8.0 Server. After registering the information of the super admin, click **Save and New**.

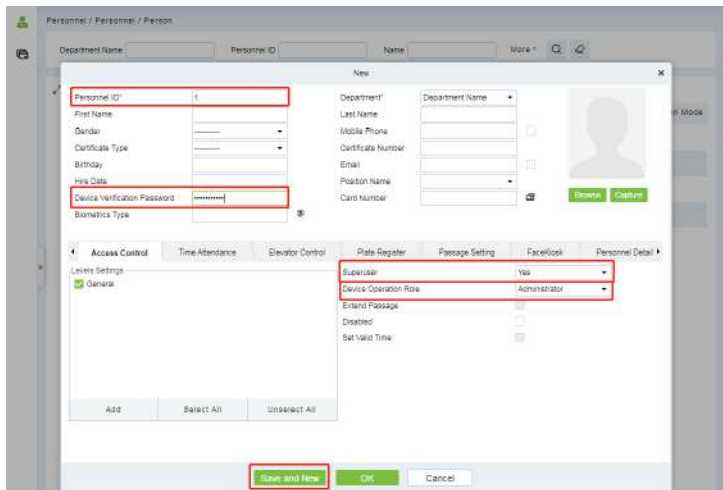

2. Click **[Access]** > **[Device]** > **[Control]** > **[Synchronize All Data to Devices]** to synchronize all the data to the device including the new users. After the data synchronization is successful, you can reset the password with the newly registered super admin. The operation steps are the same as method 1.

Method 3:

Please contact our after-sales technicians for help in recovering the password, If the device has not registered a super admin and cannot connect to the server.

New User Registration

Click the [All Users] on the WebServer to register a new user. User ID, name, password, and card number must be entered, along with setting the user role and access control role.

The screenshot displays the ZKTeco WebServer interface. On the left is a dark sidebar menu with the following sections:

- System Info**
 - Device Info
 - Device Capacity
 - Firmware Info
- User Mgt.**
 - All Users (highlighted with a red dashed box and labeled "Step 1")
- Advanced Settings**
 - COMM.
 - Cloud Service Setup
 - Date Setup
 - System
 - Serial Comm
 - Wiegand Setup
 - Access Control Options
- Device Management**
 - Device Management
 - Update Firmware
 - Change Password
 - Operation Log
 - Download Firmware Logs

The main content area is titled "Basic Info" and contains a registration form with the following fields:

- User ID: 2
- Name: Mike
- Rights: Normal User (dropdown menu)
- Password: *****
- Card Number: 1190130
- Access Control Role: 1 (dropdown menu)

Buttons include "Register", "Confirm", and "Back". A red dashed box encloses the form fields, labeled "Step 2" with the text "Enter the User Info.". A green callout points to the "Confirm" button, labeled "Step 3".

Online Registration

ZKTeco Industrial Park, No. 32, Industrial Road,
Tangxia Town, Dongguan, China.

Phone : +86 769 - 82109991

Fax : +86 755 - 89602394

www.zkteco.com

