

XMRX5

User manual



Content

1. Introduction.....	1
2. Structure design.....	2
2.1 Front view	2
2.2 Back view.....	3
3. Device operation.....	4
3.1 Live view window.....	4
3.2 Main menu	5
4. Device using.....	10

1. Introduction

XMRX5 is a full featured body worn camera specifically designed for Law Enforcement. The camera features real time HD video, 1296P recording, and a high resolution still image capture visible on the LCD screen for instant playback, with wide angle, swappable battery; The rugged design is resilient to withstand demanding work environments faced by law enforcement officers, corrections, military and security detail.

Package Contents

- * Body worn camera
- * USB cable
- * USB poser adapter
- * CD with manual and software
- * Universal metal clip

2. Structure design

2.1 Front view

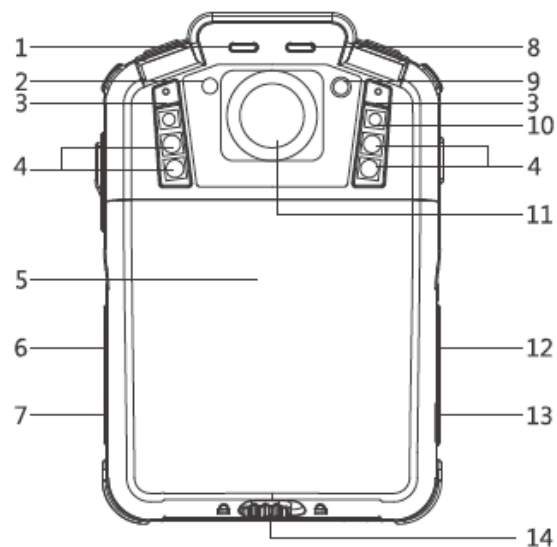

Item	Name	Description
1	Charge indicator	Solid red means camera is recharging, solid green means camera recharged well.
2	IR Sensor	The sensor will detect the brightness of the environment, and then activate the IR light and switch to night vision mode.
3	Microphone	Capture the environment voice during the recording mode.
4	IR light	Record clear image in HD in low light situations. 10 meters visible.
5	Battery cover	Remove the cover and replace the built-in battery.
6	Menu button	Press the button to enter into the configure menu to modify the parameters.
7	Playback button	Press the button to enter into the playback interface during the live view mode, review video, image and audio files.
8	Status indicator	Red blinking means video recording, yellow blinking means audio recording, solid green means standby.
9	Laser light	Pinpointing an object from a distance, solid or blinking mode
10	Lighting light	Short press the power on/off button to enable the light for auxiliary lighting.
11	Camera	High definition camera, 140 view angle.
12	Audio REC button	Press the button to start the audio recording only.
13	ON/OFF button	Press this button to start up camera or turn off camera.
14	Battery lock	Slip the lock before open the battery cover.

2.2 Back view

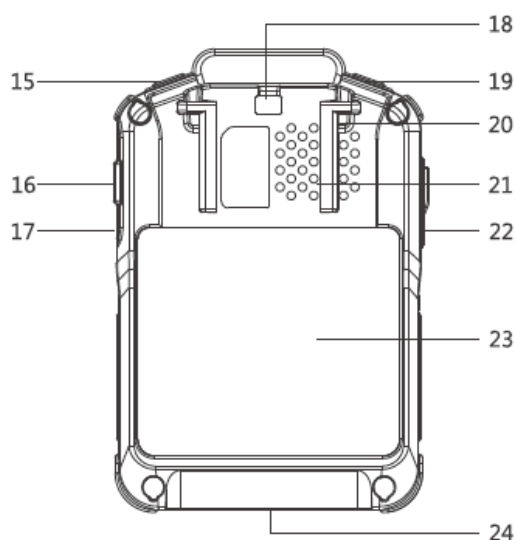

item	Name	Description
15	Video REC button	Press this button to start the video recording
16	USB port	Connects to USB cable for charging or connection to PC.
17	External camera port	Connects to external camera, when it connected in, the image will switch to external camera automatically.
18	Clip locker	The place to install different clips
19	Snapshot button	Press this button to start capture the snapshots, even during video recording mode.
20	Line hole	Put a line into the hole, and mounting the camera in different way.
21	Speaker	For voice playback, and voice report.
22	PTT button	Press to communication via connected walkie-talkie
23	LCD screen	2 inch LCD color display screen.
24	Pogo pin	The interface for docking, walkie-talkie and external battery connection.

3. Device operation





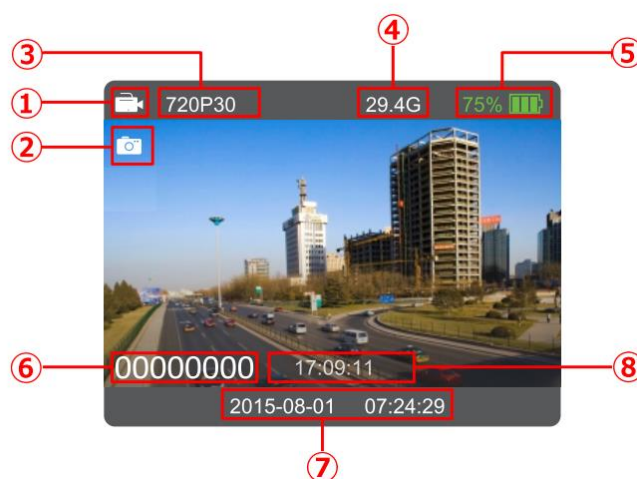

3.1 Live view window

The body worn camera LCD screen is a small monitor to display various camera information and operation status.



Item	Name	Description
1	Video recording icon	Yellow means recording
2	Snapshot icon	Yellow means snapshot success
3	Recording resolution	The resolution that camera recording
4	Storage size	The current size of the storage
5	Battery status	The current status of the battery
6	Officer ID number	The officer ID of this camera
7	Date/Time	The current date/time
8	The remain recording time	How long the storage can recording

3.2 Main menu

In preview mode, press  to enter into main menu interface, press  /  to select the option menu, and then press  to confirm the operation, and then press  /  to select the sub-options, and then press  to active the option.

Menu list:

Menu	Options
Video resolution	720P60, 720P30, 848P60, 848P30, 1296P30, 1080P30, 1440P30
Video quality	Low, Medium, High
Video clip	10min, 20min, 30min, Auto
Pre-recording	ON, OFF
Post-recording	OFF, 5sec, 10sec, 30sec, 1min, 2min, 5min, 10min
Photo pixel	5M, 8M, 10M, 12M, 16M, 21M, 32M
Snapshot	2 PCS, 3 PCS, 5 PCS, 10 PCS, 15 PCS, 20 PCS
LCD brightness	1, 2, 3, 4, 5, 6, 7, 8, 9, 10
Screen off	OFF, 30sec, 1min, 3min, 5min
Video loop	ON, OFF
Volume	0, 1, 2, 3, 4, 5, 6, 7, 8, 9, 10
Indicate sound	Mute, Voice, Beep
Key sound	ON, OFF
Hourly notice	ON, OFF
Indicate light	ON, OFF
Vibration	ON, OFF
Laser light	OFF, Manual, Auto
Auto IR switch	OFF, Manual, Auto
Language	English, 日本語, Español, русский
Auto power off	OFF, 10min, 20min, 30min, 60min
Microphone	ON, OFF
Motion detect	ON, OFF
Security password	ON, OFF
IR Sensitive	Low, Medium, High
Start logo	ON, OFF
Default setting	ON, OFF

1. Video resolution

The body worn camera offers five different recording resolutions. Resolution and frame rate options feature a proper balance between video quality and maximizing amount of video stored.

Options	Display resolution	Images per second
720P30	1280*720	30
848P60	848*480	60
848P30	848*480	30
1296P30	2304*1296	30
1080P30	1920*1080	30
1440P30	1440*1080	30
720P60	1280*720	60

2. Video quality

Select video quality based on the need of quality video recording. High means the best quality, which will encoding with big bit rate.

3. Video clip

Video clip selection defines the length of each video segment, and this option only is used for video recording, invalid for audio recording.

Sub-option: Auto, 10 minutes, 20 minutes, 30 minutes; auto means it will create a file in almost 2GB size, and the time is about one hour, depends the video resolution.

4. Pre-recording

Pre-recording saves an additional seconds of video before the video recording button is pressed, and the additional seconds is about 30 seconds. After the option of pre-recording is enabled, the camera can not snapshot, but the snapshot will work during the video recording.

For example, we set the value between setting the pre-recording and pressing the video recording as X, if $X < 30s$, the camera will save an additional video for X seconds before the video recording button is pressed, if $X \geq 30s$, the camera will save an additional video for 30 seconds before the video recording button is pressed.

5. Post-recording

Post-recording means how long the camera should continue to record after the video recording button is pressed to stop recording.

6. Photo pixel

The photo pixel provides options for still image resolution.

7. Snapshot

In preview mode, Long press the snapshot button to shoot the selected number of pictures, and you can set the option as 2 PCS, 3 PCS, 5 PCS, 10 PCS, 15 PCS, 20 PCS. When video recording is working, the option will not work.

8. LCD brightness

Adjust the body camera LCD brightness to fit lighting situation for better image and video view.

10 is highest level.

9. Screen off

Switch off the screen after a certain time if there is any operation, which will save the power consumption.

10. Video loop

When you create one new video recording file, if the file size is more than the remaining storage of camera, the camera will delete the most original file, so that the new file can be saved.

11. Volume

select volume level option to increase or decrease all the volume of camera, including playback, key sound, indicate sound and so on.

12. Indicate sound

This option means when the user do the operations with camera, It will give the accordingly response, OFF, beep or voice, and it will applied to the operations as follow:

1. start video recording;
2. Stop video recording;
3. Start audio recording;
4. Stop audio recording;
5. Power on the camera;
6. Power off the camera;

7. Low battery;

8. Inadequate storage space;

13. Key sound

Select to turn the key tone ON or OFF when you press the keys.

14. Hourly notice

Select to turn the hourly notice ON or OFF, it will give the voice report hourly if the switch is ON.

15. Indicate light

Select to turn all the LED ON or OFF, including the status LED and power LED.

16. Vibration

it will be used in the situations:

1. press the video recording button;
2. press the audio recording button;
3. Power off the camera;
4. Power on the camera.

It will remind the users that the function is in use.

17. Laser light

The laser light can be activated in this option, auto means when the video recording starts, the laser light will flash 1 minute one time; For manual mode, short press the PTT button to active it.

When it is in auto mode, we cannot press PTT button to active it.

18. Auto IR switch

If the users choose manual mode, when the camera is using video recording or in preview mode,, long press M key to active it or inactive it.

If the users choose auto mode, the IR will work when the environment is dark, similarly, when the environment is bright, the IR will be closed automatically.

19. Language

The language will be applied to the screen display and all the voice notice, and the users can choose English, 日本語, Español, русский.

20. Auto power off

Turn off the camera after a certain time if there is any operation.

21. Microphone

Select to turn the built-in microphone ON or OFF, when start audio recording, even the microphone is OFF, it will be active automatically.

22. Motion detect

If there is something moving in the screen when the device is in preview mode, the video recording will work automatically, otherwise, the video recording will stop working automatically.

23. Security password

Select to turn security password ON or OFF.

When it is ON, it will require the password when the users go to playback mode and menu mode, and the default password is 000000.

24. IR Sensitive

It will help the camera to detect the brightness of environment, and check if the camera will activate or inactivate the IR.

25. Start logo

Select to turn the start logo ON or OFF, it means the logo picture will be shown when camera start up and shutdown.

26. Default setting

When it is set as ON, the camera will auto-reboot to clear all the settings of menu, but all the playback files will still in the camera.

4. Device using



1. Turning On the Camera

In power off status, long press  for 3 seconds, the camera will be turn on and enter into preview mode automatically. Meanwhile, the status indicator will turn green.

2. Turning Off the Camera

In preview mode, long press  for 3 seconds, the camera will save the current status and power off. Meanwhile, the status indicator will turn off.



3. Snapshot

In preview mode, press  to take a photo; long press  to take more photos continuously, the quantity of photo can be configure in the menu. There is a crack sound when a photo was taken, and the photo will be saved in JPG format automatically.

4. One Touch Snapshot

In power off status, long press  to turn on the camera and a photo will be taken. The status indicator will turn red and flash. The photo will be saved in JPG format automatically.

5. Recording Video

In preview mode, short press  to start recording. Meanwhile, the status indicator will turn red and flash, and the recording icon will turn to yellow. Short press  again to stop recording, and the video will be saved in MP4 format automatically.



Remark: During video recording, long press “Audio REC” button to mark the video as important video, press again to cancel it. And press “Snapshot” button to zoom in and zoom out.

6. One Touch Video Recording



In power off status, long press  to turn on the camera and it will start recording. Meanwhile, the status indicator will turn red and flash, recording icon will turn to yellow.

Press  again to stop recording, and the video will be saved in MP4 format automatically.



7. Audio Recording

In preview mode, press  to start audio recording. Meanwhile, the status indicator will turn to yellow and flash. Press  again, the camera will stop audio recording, and the audio will be saved in WAV format automatically.

8. One Touch Audio Recording



In powered off status, long press , the camera will be turn on and start audio recording. Meanwhile, the status indicator will turn yellow and flash. Press  again, the camera will stop audio recording, and the audio will be saved in WAV format automatically.

9. IR Mode

When the users set the IR as manual mode, In preview mode or during recording a video, long press  to switch to IR mode. Long press  again to exit from IR mode.

10. White light

White light is used for auxiliary illumination when the brightness of environment is not good.





In power on status, short press  to turn on the white light, and short press  again to turn it off.





11. Laser Light

Manual mode: in preview mode or during recording a video, short press “PTT” button to turn on the laser light; short press “PTT” button again to turn it off.







Auto mode: During video recording status; it will turn on laser light to position automatically 1 min one time.

12. Playback

In the preview mode, press  to enter into the playback interface. The move left icon is  and the move right is , press  to confirm your selection, press  to exit, as the figure shown:

Left→ video  Right→ photo  OK→ playback  Exit→ menu 

13. Menu configuration

In preview mode, press  to enter menu interface, press  /  to select the option menu, and then press  to confirm the operation, and then press  /  to select corresponding icon, and then press  to active the option.

14. Charging the Battery

This camera has a chargeable battery built in. In case of low battery, please connect this camera to power supply for battery charging.

1. Charge the camera

Connect this camera and adapter via USB cable, and connect adapter to power supply to charge the battery. In charging status, the status indicator will turn red. Once the battery is fully charged, the status indicator will turn green.

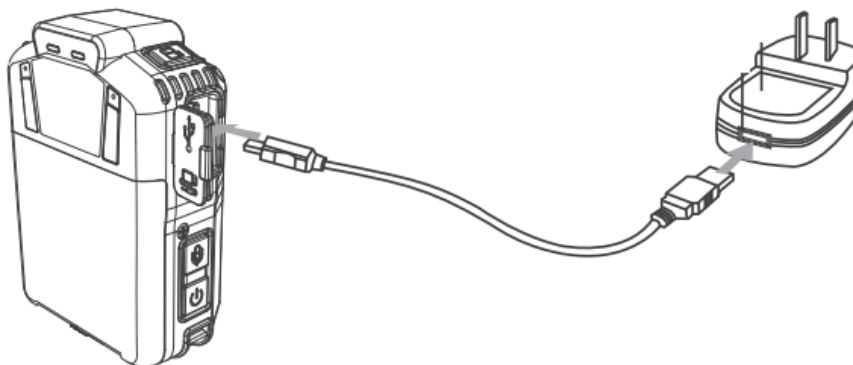

2. Charge the battery

Connect the battery charger to the power supply to charge the battery. In charging status, the status indicator will turn red. Once the battery is fully charged, the status indicator will turn green.

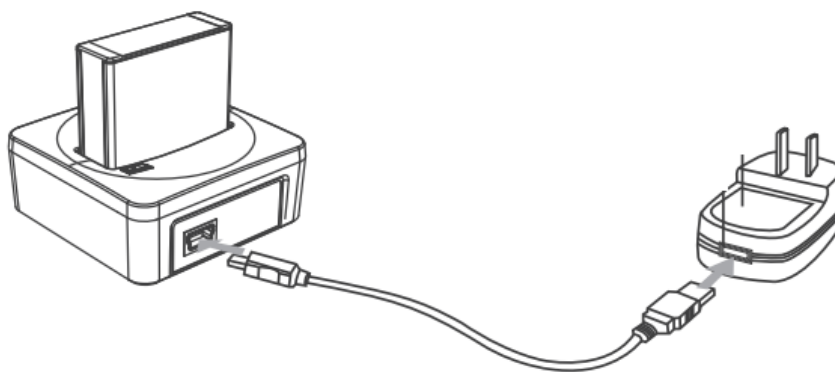

Remark: When you recharge the body camera, please make sure it is OFF. Also, even you don't use the camera for a long time; please recharge it every 3 months.

15. Replace the built-in battery

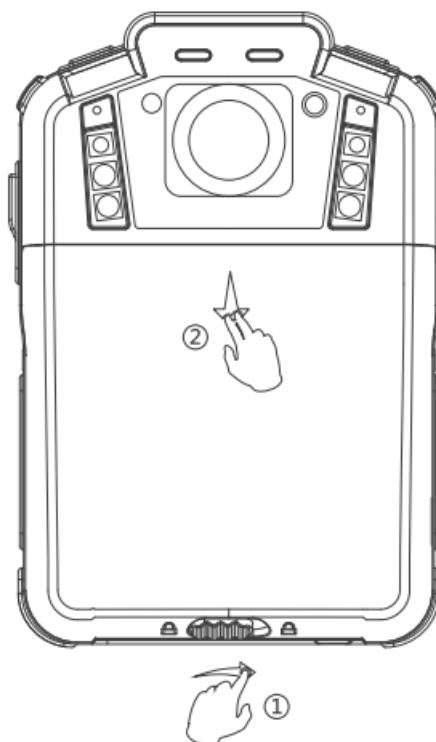

Step1: Drag the battery lock from the left side to the right side, and then the cover will be unlock. And keep the lock on the right side, and then go to step 2.

Step2: Follow the direction to pull the battery cover.