



samlexpower®

**DC-AC Power
Inverter**
Pure Sine Wave

PST-1000-12
PST-1000-24

Owner's
Manual

Please read this
manual BEFORE
installing your
inverter

OWNER'S MANUAL | Index

SECTION 1	Safety Instructions	3
SECTION 2	General Information	9
SECTION 3	Limiting Electromagnetic Interference (EMI)	16
SECTION 4	Powering Direct / Embedded Switch Mode Power Supplies (SMPS)	17
SECTION 5	Principle of Operation	19
SECTION 6	Layout.....	20
SECTION 7	General Information - Battery Related.....	21
SECTION 8	Installation	35
SECTION 9	Operation	49
SECTION 10	Protections	51
SECTION 11	Troubleshooting Guide	55
SECTION 12	Specifications	57
SECTION 13	Warranty	59

Disclaimer of Liability

UNLESS SPECIFICALLY AGREED TO IN WRITING, SAMLEX AMERICA INC.:

1. MAKES NO WARRANTY AS TO THE ACCURACY, SUFFICIENCY OR SUITABILITY OF ANY TECHNICAL OR OTHER INFORMATION PROVIDED IN ITS MANUALS OR OTHER DOCUMENTATION.
2. ASSUMES NO RESPONSIBILITY OR LIABILITY FOR LOSSES, DAMAGES, COSTS OR EXPENSES, WHETHER SPECIAL, DIRECT, INDIRECT, CONSEQUENTIAL OR INCIDENTAL, WHICH MIGHT ARISE OUT OF THE USE OF SUCH INFORMATION. THE USE OF ANY SUCH INFORMATION WILL BE ENTIRELY AT THE USERS RISK.

Samlex America reserves the right to revise this document and to periodically make changes to the content hereof without obligation or organization of such revisions or changes.

Copyright Notice/Notice of Copyright

Copyright © 2020 by Samlex America Inc. All rights reserved. Permission to copy, distribute and /or modify this document is prohibited without express written permission by Samlex America Inc.

SECTION 1 | Safety Instructions

1.1 SAFETY SYMBOLS

The following safety symbols will be used in this manual to highlight safety and information:



WARNING!

Indicates possibility of physical harm to the user in case of non-compliance.



CAUTION!

Indicates possibility of damage to the equipment in case of non-compliance.



INFO

Indicates useful supplemental information.

Please read these instructions before installing or operating the unit to prevent personal injury or damage to the unit.

1.2 SAFETY INSTRUCTIONS - GENERAL

1.2.1 Installation and wiring compliance

- Installation and wiring must comply with the Local and National Electrical Codes and must be done by a certified electrician.

1.2.2 Preventing electrical shock

- Always connect the grounding connection on the unit to the appropriate grounding system.
- Disassembly / repair should be carried out by qualified personnel only.
- Disconnect all AC and DC side connections before working on any circuits associated with the unit. Turning the ON/OFF switch on the unit to OFF position may not entirely remove dangerous voltages.
- Be careful when touching bare terminals of capacitors. Capacitors may retain high lethal voltages even after the power has been removed. Discharge the capacitors before working on the circuits.

1.2.3 Installation environment

- The inverter should be installed indoor only in a well ventilated, cool, dry environment.
- Do not expose to moisture, rain, snow or liquids of any type.
- To reduce the risk of overheating and fire, do not obstruct the suction and discharge openings of the cooling fan.
- To ensure proper ventilation, do not install in a low clearance compartment.

1.2.4 Preventing fire and explosion hazards

- Working with the unit may produce arcs or sparks. Thus, the unit should not be used in areas where there are flammable materials or gases requiring ignition protected

SECTION 1 | Safety Instructions

equipment. These areas may include spaces containing gasoline-powered machinery, fuel tanks, and battery compartments.

1.2.5 Precautions when working with batteries

- Batteries contain very corrosive diluted Sulphuric Acid as electrolyte. Precautions should be taken to prevent contact with skin, eyes or clothing.
- Batteries generate Hydrogen and Oxygen during charging resulting in evolution of explosive gas mixture. Care should be taken to ventilate the battery area and follow the battery manufacturer's recommendations.
- Never smoke or allow a spark or flame near the batteries.
- Use caution to reduce the risk of dropping a metal tool on the battery. It could spark or short circuit the battery or other electrical parts and could cause an explosion.
- Remove metal items like rings, bracelets and watches when working with batteries. The batteries can produce a short circuit current high enough to weld a ring or the like to metal and thus, cause a severe burn.
- If you need to remove a battery, always remove the ground terminal from the battery first. Make sure that all the accessories are off so that you do not cause a spark.

1.3 SAFETY INSTRUCTIONS - INVERTER RELATED

1.3.1 Preventing Paralleling of the AC Output

The AC output of the unit should never be connected directly to an Electrical Breaker Panel / Load Centre which is also fed from the utility power / generator. Such a direct connection may result in parallel operation of the different power sources and AC power from the utility / generator will be fed back into the unit which will instantly damage the output section of the unit and may also pose a fire and safety hazard. If an Electrical Breaker Panel / Load Center is fed from this unit and this panel is also required to be fed from additional alternate AC sources, the AC power from all the AC sources (*like the utility / generator / this inverter*) should first be fed to an Automatic / Manual Selector Switch and the output of the Selector Switch should be connected to the Electrical Breaker Panel / Load Center. Samlex America, Inc. Automatic Transfer Switch model No. STS-30 is recommended for this application.



CAUTION!

To prevent possibility of paralleling and severe damage to the unit, never use a simple jumper cable with a male plug on both ends to connect the AC output of the unit to a handy wall receptacle in the home / RV.



ATTENTION!

Pour éviter toute possibilité de mise en parallèle et de graves dommages à l'appareil, n'utilisez jamais un simple câble de raccordement muni d'une fiche mâle aux deux extrémités pour connecter la sortie CA de l'appareil à une prise murale pratique dans le logement / véhicule de loisir.

SECTION 1 | Safety Instructions

1.3.2 Preventing DC Input Over Voltage

It is to be ensured that the DC input voltage does not exceed 16.5 VDC for PST-1000-12 or 33.0 VDC for PST-1000-24 to prevent permanent damage to the unit. Please observe the following precautions:

- Ensure that the maximum charging voltage of the external battery charger / alternator / solar charge controller does not exceed 16.5 VDC for PST-1000-12 or 33.0 for PST-1000-24.
- Do not connect this unit to a battery system with a voltage higher than the rated nominal battery input voltage of the unit.
- When using Diversion Charge Control Mode in a Charge Controller, the solar/ wind/ hydro source is directly connected to the battery bank. In this case, the Controller will divert excess current to an external load. As the battery charges, the diversion duty cycle will increase. When the battery is fully charged, all the source energy will flow into the diversion load if there are no other loads. The Charge Controller will disconnect the diversion load if the current rating of the Controller is exceeded. Disconnection of the diversion load may damage the battery as well as the inverter or other DC loads connected to the battery due to high voltages generated during conditions of high winds (*for wind generators*), high water flow rates (*for hydro generators*). It is, therefore, to be ensured that the diversion load is sized correctly to prevent the above over voltage conditions.
- Do not use solar panel/array to directly charge the battery bank connected to the inverter. Use appropriate Charge Controller between the solar panel/array and the battery bank. Using solar panel/array to directly charge the battery will lead to over voltage shutdown of the inverter and the possible damage due to battery voltage rising close to the level of the open circuit voltage of the solar panel(s) when the battery is fully charged and is in Float stage (under this condition, the battery will be drawing very low trickle charge current & the voltage of the unregulated solar panellarray will rise close to its Open Circuit Voltage).

1.3.3 Preventing Reverse Polarity on the Input Side

When making battery connections on the input side, make sure that the polarity of battery connections is correct (Connect the Positive of the battery to the Positive terminal of the unit and the Negative of the battery to the Negative terminal of the unit). If the input is connected in reverse polarity, DC fuse(s) inside the inverter will blow and may also cause permanent damage to the inverter.



CAUTION!

Damage caused by reverse polarity is not covered by warranty.



ATTENTION!

Les dommages causés par l'inversion de polarité ne sont pas couverts par la garantie.

SECTION 1 | Safety Instructions

1.3.4 Use of External Fuse in DC input Circuit

Use Class-T or equivalent fuse of appropriate capacity within 7" of the battery Positive terminal. This fuse is required to protect DC input cable run from damage due to short circuit along the length of the cable. Please read instructions under Section 8 - Installation.

1.4 LES SYMBOLES DE SÉCURITÉ

Les symboles de sécurité suivants seront utilisés dans ce manuel pour souligner les informations liées à la sécurité lors de l'installation et de l'utilisation :



MISE EN GARDE!

L'utilisateur pourrait se blesser si les consignes de sécurité ne sont pas suivies.



ATTENTION!

Il y a un risque de faire des dégâts à l'équipement lorsque l'utilisateur ne suit pas les instructions.



INFO

Indication de l'info supplémentaire qui pourrait être utiles.

Veillez lire ces instructions avant d'installer ou de faire fonctionner l'appareil afin de prévenir des blessures corporelles ou des dégâts à l'appareil.

1.5 CONSIGNES DE SÉCURITÉ - GÉNÉRALES

1.5.1 Installation et Conformité du Câblage

- L'installation et le câblage doivent conformer aux Normes Électriques Locales et Nationales; l'installation doit être faite par un(e) électricien(ne) CERTIFIÉ(E).

1.5.2 Prévention des Décharges Électriques

- Connectez toujours la connexion de terre de l'appareil au système de terre approprié.
- Seulement une personne qualifiée devrait réparer ou désassembler cet appareil.
- Débranchez tous les raccordements latéraux d'entrée et de sortie avant de travailler sur n'importe quel circuit associé au contrôleur de charge. Même si l'interrupteur «ON/ OFF» est dans la position «off», il pourrait rester des tensions dangereuses.
- Faites attention de ne pas toucher les bornes nues des condensateurs. Elles pourraient retenir des tensions mortelles, même quand une puissance a été enlevée. Déchargez les condensateurs avant de travailler sur les circuits.

1.5.3 Lieu d'Installation

- Il faut situer l'onduleur à l'intérieur dans un endroit bien frais, sec, et ventilé.
- Ne pas exposer à l'humidité, la pluie, la neige ou à toutes liquides.
- Afin de réduire les risques de la surchauffe ou d'un incendie, ne bloquez pas les ouvertures d'admission et d'échappement pour les ventilateurs de refroidissement.
- Pour assurer une bonne ventilation, n'installez pas l'appareil dans un compartiment avec peu d'espace.

SECTION 1 | Safety Instructions

1.5.4 Prévention des Risques d'Incendie et d'Explosion

- L'utilisation de l'appareil pourrait produire des arcs électriques ou des étincelles. Par conséquent, il ne devrait pas être utilisé dans les endroits où il y a des matériaux ou gaz nécessitant des équipements ignifuges, par exemple, des espaces contenant des machines alimentées par essence, des réservoirs d'essence ou, des compartiments à batterie.

1.5.5 Précautions à Prendre en Travaillant avec des Batteries

- Les batteries contiennent de l'acide sulfurique, électrolyte corrosif. Certaines précautions doivent être prises afin d'empêcher tout contact avec la peau, les yeux ou les vêtements.
- Lorsque les batteries sont rechargées, elle produisent de l'oxygène et de l'hydrogène, ceci émet un mélange de gaz explosif. Ventilez à fond la zone de la batterie et, suivez les recommandations du fabricant pour l'emploi de la batterie.
- Ne jamais fumer ni mettre une flamme à proximité des batteries.
- Soyez prudent, réduisez toute risque de chute d'objets métalliques sur la batterie, ce qui pourrait provoquer des étincelles, ou court-circuiter la batterie et les autres pièces électriques, et causer une explosion.
- Retirez tous vos objets métalliques: bagues, bracelets, montres, etc. lorsque vous travaillez avec les batteries. Les batteries pourraient produire un court-circuit assez puissant pour souder des objets causant une brûlure grave.
- Si vous devez enlever la batterie, retirez toujours la borne négative (de terre) de la batterie en premier. Assurez que tous les accessoires soient éteints, pour ne pas provoquer des étincelles.

1.6 CONSIGNES DE SÉCURITÉ - POUR L'ONDULEUR

1.6.1 Empêcher la Sortie CA de Se Mettre en Parallèle

La sortie CA de l'appareil ne devrait jamais être branchée directement à un tableau électrique qui est aussi alimenté par la puissance d'un service public / d'un générateur. Une connexion pareille pourrait résulter dans un fonctionnement en parallèle de ces derniers et, la puissance CA produite par un service public / générateur serait alimentée à l'appareil causant des dégâts à la section de sortie, et engendrant une risque d'incendie ou de faire mal. Si le tableau électrique est alimenté par l'appareil et une puissance CA supplémentaire est requise, la puissance CA des sources comme le service public / générateur / onduleur devrait être envoyée en premier, à un sélecteur; la sortie du sélecteur devrait être liée au tableau électrique. Samlex Amérique, Inc. modèle de commutateur transter automatique n ° STS-30 est recommandé pour cette application.



ATTENTION!

Afin de d'éviter la possibilité que l'appareil se met en parallèle ou devient fortement endommagé, n'utilisez pas un câble de raccordement pour lier la sortie CA de l'appareil à un réceptacle mural commode dans la maison/le VR.

SECTION 1 | Safety Instructions

1.6.2 Prévention d'une Surtension de l'Entrée CC

Il faut assurer que la tension d'entrée CC de cet appareil n'excede pas une tension de 16,5 VCC pour PST-1000-12 ou 33.0 VCC pour PST-1000-24 afin d'empêcher des dégâts permanents à l'appareil. Veuillez suivre les consignes suivantes:

- Assurez que la tension de chargement maximale du chargeur de batterie/ l'alternateur/ contrôleur de charge externe n'excede pas une tension de 16,5 VCC pour PST-1000-12 ou 33.0 VCC pour PST-1000-24.
- Ne pas connecter cet appareil à un système de batterie avec une tension supérieure à la tension nominale d'entrée de la batterie de l'appareil.
- Lorsque vous utilisez le mode de contrôle de charge de détournement dans un contrôleur de charge, la source solaire / éolienne / hydroélectrique est directement connectée au groupe de batteries. Dans ce cas, le contrôleur détournera le surplus de courant vers une charge externe. Au fur et à mesure que la batterie se charge, le cycle de réacheminement augmente. Lorsque la batterie est complètement chargée, toute l'énergie de la source ira dans la charge de déviation s'il n'y a pas d'autres charges. Le contrôleur de charge déconnectera la charge de déviation si le courant nominal du contrôleur est dépassé. La déconnexion de la charge de dérivation peut endommager la batterie, ainsi que l'onduleur ou d'autres charges CC connectées à la batterie, en raison des tensions élevées générées par vent fort (*pour les éoliennes*) et des débits d'eau importants (*pour les centrales hydroélectriques*). Il faut donc s'assurer que la charge de dérivation est correctement dimensionnée pour éviter les conditions de surtension ci-dessus.
- N'utilisez pas de panneaux solaires pour charger directement le groupe de batteries connecté à l'onduleur. Utilisez le contrôleur de charge approprié entre le panneau / générateur solaire et le groupe de batteries. L'utilisation d'un panneau solaire pour charger directement la batterie entraînera un arrêt de surtension de l'onduleur et des dommages éventuels dus à une montée de la tension de la batterie proche du niveau de la tension de circuit ouvert du ou des panneaux solaires lorsque la batterie est complètement chargée et est en phase de flotter.

1.6.3 Prévention de Polarités Inversées sur le Côté d'Entrée

Quand vous faites des connexions à la batterie du côté d'entrée, veuillez assurer que les polarités sont mises du bon côté (*Liez le Positif de la batterie à la borne Positive de l'appareil et le Négatif de la batterie à la borne Négative de l'appareil*). Si les polarités de l'entrée sont mises à l'envers, le(s) fusible(s) CC dans l'onduleur va s'exploser et pourrait causer des dégâts permanents à l'onduleur.



ATTENTION!

Des dégâts causés par un inversement des polarités ne sont pas couverts par la garantie.

1.6.4 L'utilisation de fusible externe dans le circuit d'entrée CC

Utilisez Classe-T ou le fusible équivalent de capacités appropriées dans les 7 pouces de la borne positive de la batterie. Ce fusible est nécessaire pour protéger le câble CC d'entrée des dommages dus à un court-circuit le long de la longueur du câble. S'il vous plaît lisez les instructions vertu de l'article 8 - Installation.

SECTION 2 | General Information

2.1. DEFINITIONS

The following definitions are used in this manual for explaining various electrical concepts, specifications and operations:

Peak Value: It is the maximum value of electrical parameter like voltage / current.

RMS (Root Mean Square) Value: It is a statistical average value of a quantity that varies in value with respect to time. For example, a pure sine wave that alternates between peak values of Positive 169.68V and Negative 169.68V has an RMS value of 120 VAC. Also, for a pure sine wave, the RMS value = Peak value \div 1.414.

Voltage (V), Volts: It is denoted by "V" and the unit is "Volts". It is the electrical force that drives electrical current (I) when connected to a load. It can be DC (Direct Current – flow in one direction only) or AC (Alternating Current – direction of flow changes periodically). The AC value shown in the specifications is the RMS (Root Mean Square) value.

Current (I), Amps, A: It is denoted by "I" and the unit is Amperes – shown as "A". It is the flow of electrons through a conductor when a voltage (V) is applied across it.

Frequency (F), Hz: It is a measure of the number of occurrences of a repeating event per unit time. For example, cycles per second (or Hertz) in a sinusoidal voltage.

Efficiency, (η): This is the ratio of Power Output \div Power Input.

Phase Angle, (ϕ): It is denoted by " ϕ " and specifies the angle in degrees by which the current vector leads or lags the voltage vector in a sinusoidal voltage. In a purely inductive load, the current vector lags the voltage vector by Phase Angle (ϕ) = 90°. In a purely capacitive load, the current vector leads the voltage vector by Phase Angle, (ϕ) = 90°. In a purely resistive load, the current vector is in phase with the voltage vector and hence, the Phase Angle, (ϕ) = 0°. In a load consisting of a combination of resistances, inductances and capacitances, the Phase Angle (ϕ) of the net current vector will be $> 0^\circ < 90^\circ$ and may lag or lead the voltage vector.

Resistance (R), Ohm, Ω : It is the property of a conductor that opposes the flow of current when a voltage is applied across it. In a resistance, the current is in phase with the voltage. It is denoted by "R" and its unit is "Ohm" - also denoted as " Ω ".

Inductive Reactance (X_L), Capacitive Reactance (X_C) and Reactance (X): Reactance is the opposition of a circuit element to a change of electric current or voltage due to that element's inductance or capacitance. Inductive Reactance (X_L) is the property of a coil of wire in resisting any change of electric current through the coil. It is proportional to frequency and inductance and causes the current vector to lag the voltage vector by Phase Angle (ϕ) = 90°. Capacitive reactance (X_C) is the property of capacitive elements to oppose changes in voltage. X_C is inversely proportional to the frequency and capacitance and causes the current vector to lead the voltage vector by Phase Angle (ϕ) = 90°. The unit of both X_L and X_C is "Ohm" - also denoted as " Ω ". The effects of inductive reac-

SECTION 2 | General Information

tance X_L to cause the current to lag the voltage by 90° and that of the capacitive reactance X_C to cause the current to lead the voltage by 90° are exactly opposite and the net effect is a tendency to cancel each other. Hence, in a circuit containing both inductances and capacitances, the net **Reactance (X)** will be equal to the difference between the values of the inductive and capacitive reactances. The net **Reactance (X)** will be inductive if $X_L > X_C$ and capacitive if $X_C > X_L$.

Impedance, Z: It is the vectorial sum of Resistance and Reactance vectors in a circuit.

Active Power (P), Watts: It is denoted as "P" and the unit is "Watt". It is the power that is consumed in the resistive elements of the load. A load will require additional Reactive Power for powering the inductive and capacitive elements. The effective power required would be the Apparent Power that is a vectorial sum of the Active and Reactive Powers.

Reactive Power (Q), VAR: Is denoted as "Q" and the unit is VAR. Over a cycle, this power is alternatively stored and returned by the inductive and capacitive elements of the load. It is not consumed by the inductive and capacitive elements in the load but a certain value travels from the AC source to these elements in the (+) half cycle of the sinusoidal voltage (Positive value) and the same value is returned back to the AC source in the (-) half cycle of the sinusoidal voltage (Negative value). Hence, when averaged over a span of one cycle, the net value of this power is 0. However, on an instantaneous basis, this power has to be provided by the AC source. *Hence, the inverter, AC wiring and over current protection devices have to be sized based on the combined effect of the Active and Reactive Powers that is called the Apparent Power.*

Apparent (S) Power, VA: This power, denoted by "S", is the vectorial sum of the Active Power in Watts and the Reactive Power in "VAR". In magnitude, it is equal to the RMS value of voltage "V" X the RMS value of current "A". The Unit is VA. *Please note that Apparent Power VA is more than the Active Power in Watts. Hence, the inverter, AC wiring and over current protection devices have to be sized based on the Apparent Power.*

Maximum Continuous Running AC Power Rating: This rating may be specified as "Active Power" in Watts (W) or "Apparent Power" in Volt Amps (VA). It is normally specified in "Active Power (P)" in Watts for Resistive type of loads that have Power Factor =1. Reactive types of loads will draw higher value of "Apparent Power" that is the sum of "Active and Reactive Powers". Thus, AC power source should be sized based on the higher "Apparent Power" Rating in (VA) for all Reactive Types of AC loads. If the AC power source is sized based on the lower "Active Power" Rating in Watts (W), the AC power source may be subjected to overload conditions when powering Reactive Type of loads.

Starting Surge Power Rating: During start up, certain loads require considerably higher surge of power for short duration (lasting from tens of milliseconds to few seconds) as compared to their Maximum Continuous Running Power Rating. Some examples of such loads are given below:

- **Electric Motors:** At the moment when an electric motor is powered ON, the rotor is stationary (equivalent to being "Locked"), there is no "Back EMF" and the windings draw a very heavy surge of starting current (Amperes) called "Locked Rotor Am-

SECTION 2 | General Information

peres" (*LRA*) due to low DC resistance of the windings. For example, in motor driven loads like Air-conditioning and Refrigeration Compressors and in Well Pumps (using Pressure Tank), the Starting Surge Current / LRA may be as high as 10 times its rated Full Load Amps (*FLA*) / Maximum Continuous Running Power Rating. The value and duration of the Starting Surge Current / LRA of the motor depends upon the winding design of the motor and the inertia / resistance to movement of mechanical load being driven by the motor. As the motor speed rises to its rated RPM, "Back EMF" proportional to the RPM is generated in the windings and the current draw reduces proportionately till it draws the running FLA / Maximum Continuous Running Power Rating at the rated RPM.

- **Transformers** (e.g. *Isolation Transformers, Step-up / Step-down Transformers, Power Transformer in Microwave Oven etc.*): At the moment when AC power is supplied to a transformer, the transformer draws very heavy surge of "Magnetization Inrush Current" for a few milliseconds that can reach up to 10 times the Maximum Continuous Rating of the Transformer.
- **Devices like Infrared Quartz Halogen Heaters** (also used in *Laser Printers*) / **Quartz Halogen Lights / Incandescent Light Bulbs using Tungsten heating elements**: Tungsten has a very high Positive Temperature Coefficient of Resistance i.e. it has lower resistance when cold and higher resistance when hot. As Tungsten heating element will be cold at the time of powering ON, its resistance will be low and hence, the device will draw very heavy surge of current with consequent very heavy surge of power with a value of up to 8 times the Maximum Continuous Running AC Power.
- **AC to DC Switched Mode Power Supplies (SMPS)**: This type of power supply is used as stand-alone power supply or as front end in all electronic devices powered from Utility / Grid e.g. in audio/video/ computing devices and battery chargers (*Please see Section 4 for more details on SMPS*). When this power supply is switched ON, its internal input side capacitors start charging resulting in very high surge of Inrush Current for a few milliseconds (*Please see Fig 4.1*). This surge of inrush current / power may reach up to 15 times the Continuous Maximum Running Power Rating. The surge of inrush current / power will, however, be limited by the Surge Power Rating of the AC source.

Power Factor, (PF): It is denoted by "PF" and is equal to the ratio of the Active Power (P) in Watts to the Apparent Power (S) in VA. The maximum value is 1 for resistive types of loads where the Active Power (P) in Watts = the Apparent Power (S) in VA. It is 0 for purely inductive or purely capacitive loads. Practically, the loads will be a combination of resistive, inductive and capacitive elements and hence, its value will be $0 < PF < 1$. Normally it ranges from 0.5 to 0.8 e.g. (i) AC motors (0.4 to 0.8), (ii) Transformers (0.8) (iii) AC to DC Switch Mode Power Supplies (0.5 to 0.6) etc.

Load: Electrical appliance or device to which an electrical voltage is fed.

Linear Load: A load that draws sinusoidal current when a sinusoidal voltage is fed to it. Examples are, incandescent lamp, heater, electric motor, etc.

Non-Linear Load: A load that does not draw a sinusoidal current when a sinusoidal voltage is fed to it. For example, non-power factor corrected Switched Mode Power Supplies (*SMPS*) used in computers, audio video equipment, battery chargers, etc.

SECTION 2 | General Information

Resistive Load: A device or appliance that consists of pure resistance (*like filament lamps, cook tops, toaster, coffee maker etc.*) and draws only Active Power (*Watts*) from the inverter. The inverter can be sized based on the Active Power rating (*Watts*) of resistive type of loads without creating overload (*except for resistive type of loads with Tungsten based heating element like in Incandescent Light Bulbs, Quartz Halogen Lights and Quartz Halogen Infrared Heaters. These require higher starting surge power due to lower resistance value when the heating element is cold.*)

Reactive Load: A device or appliance that consists of a combination of resistive, inductive and capacitive elements (*like motor driven tools, refrigeration compressors, microwaves, computers, audio/ video etc.*). The Power Factor of this type of load is < 1 e.g. AC motors ($PF=0.4$ to 0.8), Transformers ($PF=0.8$), AC to DC Switch Mode Power Supplies ($PF=0.5$ to 0.6) etc. These devices require Apparent Power (*VA*) from the AC power source. The Apparent Power is a vectorial sum of Active Power (*Watts*) and Reactive Power (*VAR*). *The AC power source has to be sized based on the higher Apparent Power (VA) and also based on the Starting Surge Power.*

2.2 OUTPUT VOLTAGE WAVEFORMS

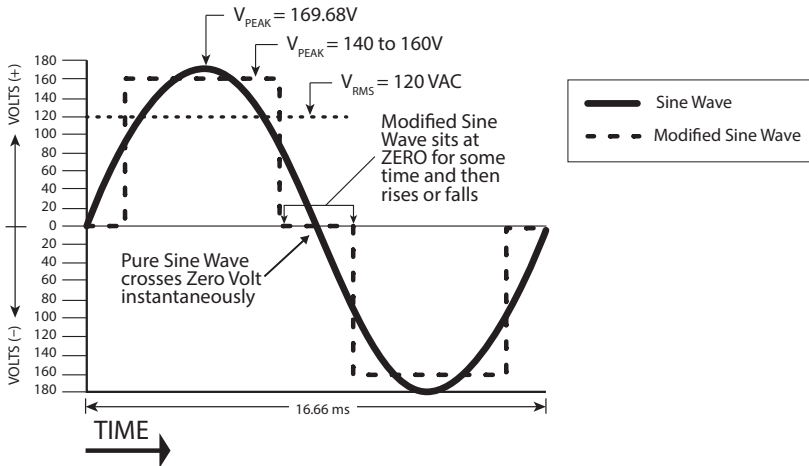

Fig. 2.1: Pure and Modified Sine Waveforms for 120 VAC, 60 Hz

The output waveform of the Samlex PST series inverters is a Pure Sine Wave like the waveform of Utility / Grid Power. Please see Sine Wave represented in the Fig. 2.1 that also shows Modified Sine Waveform for comparison.

In a Sine Wave, the voltage rises and falls smoothly with a smoothly changing phase angle and also changes its polarity instantly when it crosses 0 Volts. In a Modified Sine Wave, the voltage rises and falls abruptly, the phase angle also changes abruptly and it sits at zero V for some time before changing its polarity. Thus, any device that uses a control circuitry that senses the phase (*for voltage / speed control*) or instantaneous zero

SECTION 2 | General Information

voltage crossing (*for timing control*) will not work properly from a voltage that has a Modified Sine Waveform.

Also, as the Modified Sine Wave is a form of Square Wave, it is comprised of multiple Sine Waves of odd harmonics (*multiples*) of the fundamental frequency of the Modified Sine Wave. For example, a 60 Hz Modified Sine Wave will consist of Sine Waves with odd harmonic frequencies of 3rd (*180 Hz*), 5th (*300 Hz*), 7th (*420 Hz*) and so on. The high frequency harmonic content in a Modified Sine Wave produces enhanced radio interference, higher heating effect in inductive loads like microwaves and motor driven devices like hand tools, refrigeration / air-conditioning compressors, pumps etc. The higher frequency harmonics also produce overloading effect in low frequency capacitors due to lowering of their capacitive reactance by the higher harmonic frequencies. These capacitors are used in ballasts for fluorescent lighting for Power Factor improvement and in single-phase induction motors as Start and Run Capacitors. Thus, Modified and Square Wave inverters may shut down due to overload when powering these devices.

2.3 ADVANTAGES OF PURE SINE WAVE INVERTERS

- The output waveform is a Sine Wave with very low harmonic distortion and cleaner power like Utility / Grid supplied electricity.
- Inductive loads like microwaves, motors, transformers etc. run faster, quieter and cooler.
- More suitable for powering fluorescent lighting fixtures containing Power Factor Improvement Capacitors and single phase motors containing Start and Run Capacitors
- Reduces audible and electrical noise in fans, fluorescent lights, audio amplifiers, TV, fax and answering machines, etc.
- Does not contribute to the possibility of crashes in computers, weird print outs and glitches in monitors.

2.4 SOME EXAMPLES OF DEVICES THAT MAY NOT WORK PROPERLY WITH MODIFIED SINE WAVE AND MAY ALSO GET DAMAGED ARE GIVEN BELOW:

- Laser printers, photocopiers, and magneto-optical hard drives.
- Built-in clocks in devices such as clock radios, alarm clocks, coffee makers, bread-makers, VCR, microwave ovens etc. may not keep time correctly.
- Output voltage control devices like dimmers, ceiling fan / motor speed control may not work properly (*dimming / speed control may not function*).
- Sewing machines with speed / microprocessor control.
- Transformer-less capacitive input powered devices like (i) Razors, flashlights, night-lights, smoke detectors etc. (ii) Some re-chargers for battery packs used in hand power tools. *These may get damaged. Please check with the manufacturer of these types of devices for suitability.*
- Devices that use radio frequency signals carried by the AC distribution wiring.

SECTION 2 | General Information

- Some new furnaces with microprocessor control / Oil burner primary controls.
- High intensity discharge (*HID*) lamps like Metal Halide Lamps. *These may get damaged. Please check with the manufacturer of these types of devices for suitability.*
- Some fluorescent lamps / light fixtures that have Power Factor Correction Capacitors. *The inverter may shut down indicating overload.*
- Induction Cooktops

2.5 POWER RATING OF INVERTERS



INFO

For proper understanding of explanations given below, please refer to definitions of Active / Reactive / Apparent / Continuous / Surge Powers, Power Factor, and Resistive / Reactive Loads at Section 2.1 under "DEFINITIONS".

The power rating of inverters is specified as follows:

- Maximum Continuous Running Power Rating
- Surge Power Rating to accommodate high, short duration surge of power required during start up of certain AC appliances and devices.

Please read details of the above two types of power ratings in Section 2.1 under "DEFINITIONS"



INFO

The manufacturers' specification for power rating of AC appliances and devices indicates only the Maximum Continuous Running Power Rating. The high, short duration surge of power required during start up of some specific types of devices has to be determined by actual testing or by checking with the manufacturer. This may not be possible in all cases and hence, can be guessed at best, based on some general Rules of Thumb.

Table 2.1 provides a list of some common AC appliances / devices that require high, short duration surge of power during start up. An "Inverter Sizing Factor" has been recommended against each which is a Multiplication Factor to be applied to the Rated Continuous Running Power Rating of the AC appliance / device to arrive at the Rated Continuous Running Power Rating of the inverter.

SECTION 2 | General Information

TABLE 2.1: INVERTER SIZING FACTOR Type of Device or Appliance	Inverter Sizing Factor (See note 1)
Air Conditioner / Refrigerator / Freezer (Compressor based)	5
Air Compressor	4
Sump Pump / Well Pump / Submersible Pump	3
Dishwasher / Clothes Washer	3
Microwave (where rated output power is the cooking power)	2
Furnace Fan	3
Industrial Motor	3
Portable Kerosene / Diesel Fuel Heater	3
Circular Saw / Bench Grinder	3
Incandescent / Halogen / Quartz Lamps	3
Ceramic/ Positive Temperature Coefficient (PTC) type of heaters	5
Laser Printer / Other Devices using Infrared Quartz Halogen Heaters	4
Switch Mode Power Supplies (SMPS): no Power Factor correction	2
Photographic Strobe / Flash Lights	4 (See Note 2)

NOTES FOR TABLE 2.1

1. Multiply the Rated Continuous Running Power Rating of the appliance / device by the recommended Sizing Factor to arrive at the Rated Continuous Running Power Rating of the inverter.
2. For photographic strobe / flash unit, the Surge Power Rating of the inverter should be > 4 times the Watt Sec rating of photographic strobe / flash unit.

SECTION 3 | Limiting Electro-Magnetic Interference (EMI)

3.1 EMI AND FCC COMPLIANCE

These inverters contain internal switching devices that generate conducted and radiated electromagnetic interference (*EMI*). The EMI is unintentional and cannot be entirely eliminated. The magnitude of EMI is, however, limited by circuit design to acceptable levels as per limits laid down in North American FCC Standard FCC Part 15(B), Class B. These limits are designed to provide reasonable protection against harmful interference when the equipment is operated *in a residential environment*. These inverters can conduct and radiate radio frequency energy and, if not installed and used in accordance with the instruction manual, may cause harmful interference to radio communications.

3.2 REDUCING EMI THROUGH PROPER INSTALLATION

The effects of EMI will also depend upon a number of factors external to the inverter like proximity of the inverter to the EMI receptors, types and quality of connecting wires and cables etc. EMI due to factors external to the inverter may be reduced as follows:

3.2.1 EMI due to factors external to the inverter may be reduced as follows:

- Ensure that the inverter is firmly grounded to the ground system of the building or the vehicle
- Locate the inverter as far away from the EMI receptors like radio, audio and video devices as possible
- Keep the DC side wires between the battery and the inverter as short as possible.
- Do NOT keep the battery wires far apart. Keep them taped together to reduce their inductance and induced voltages. This reduces ripple in the battery wires and improves performance and efficiency.
- Shield the DC side wires with metal sheathing / copper foil / braiding:
 - Use coaxial shielded cable for all antenna inputs (instead of 300 ohm twin leads)
 - Use high quality shielded cables to attach audio and video devices to one another
- Limit operation of other high power loads when operating audio / video equipment

SECTION 4 | Powering Direct / Embedded Switch Mode Power Supplies (SMPS)

4.1 CHARACTERISTICS OF SWITCHED MODE POWER SUPPLIES (SMPS)

Switch Mode Power Supplies (*SMPS*) are extensively used to convert the incoming AC power into various voltages like 3.3V, 5V, 12V, 24V etc. that are used to power various devices and circuits used in electronic equipment like battery chargers, computers, audio and video devices, radios etc. SMPS use large capacitors in their input section for filtration. When the power supply is first turned on, there is a very large inrush current drawn by the power supply as the input capacitors are charged (*The capacitors act almost like a short circuit at the instant the power is turned on*). The inrush current at turn-on is several to tens of times larger than the rated RMS input current and lasts for a few milliseconds. An example of the input voltage versus input current waveforms is given in Fig. 4.1. It will be seen that the initial input current pulse just after turn-on is > 15 times larger than the steady state RMS current. The inrush dissipates in around 2 or 3 cycles i.e. in around 33 to 50 milliseconds for 60 Hz sine wave.

Further, due to the presence of high value of input filter capacitors, the current drawn by an SMPS (*With no Power Factor correction*) is not sinusoidal but non-linear as shown in Fig 4.2. The steady state input current of SMPS is a train of non-linear pulses instead of a sinusoidal wave. These pulses are two to four milliseconds duration each with a very high Crest Factor of around 3 (*Crest Factor = Peak value ÷ RMS value*).

Many SMPS units incorporate "Inrush Current Limiting". The most common method is the NTC (*Negative Temperature Coefficient*) resistor. The NTC resistor has a high resistance when cold and a low resistance when hot. The NTC resistor is placed in series with the input to the power supply. The cold resistance limits the input current as the input capacitors charge up. The input current heats up the NTC and the resistance drops during normal operation. However, if the power supply is quickly turned off and back on, the NTC resistor will be hot so its low resistance state will not prevent an inrush current event.

The inverter should, therefore, be sized adequately to withstand the high inrush current and the high Crest Factor of the current drawn by the SMPS. Normally, inverters have short duration Surge Power Rating of 2 times their Maximum Continuous Power Rating. *Hence, it is recommended that for purposes of sizing the inverter to accommodate Crest Factor of 3, the Maximum Continuous Power Rating of the inverter should be > 2 times the Maximum Continuous Power Rating of the SMPS. For example, an SMPS rated at 100 Watts should be powered from an inverter that has Maximum Continuous Power Rating of > 200 Watts.*

SECTION 4 | Powering Direct / Embedded Switch Mode Power Supplies (SMPS)

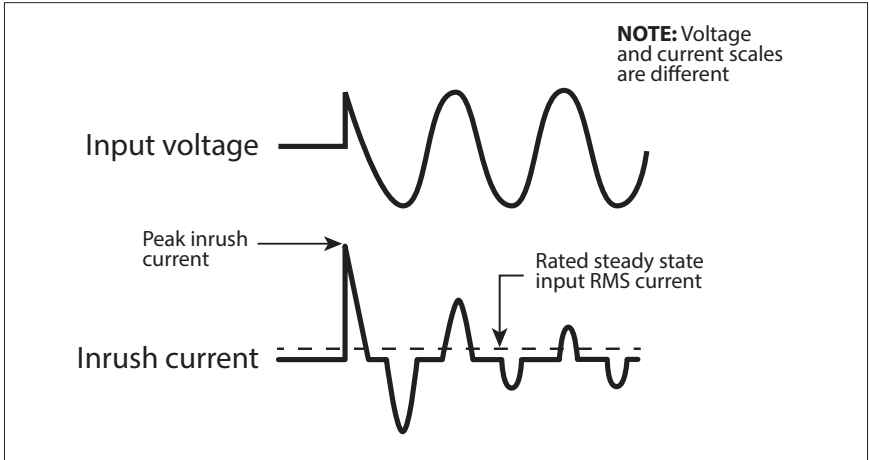

Fig 4.1: Inrush current in an SMPS

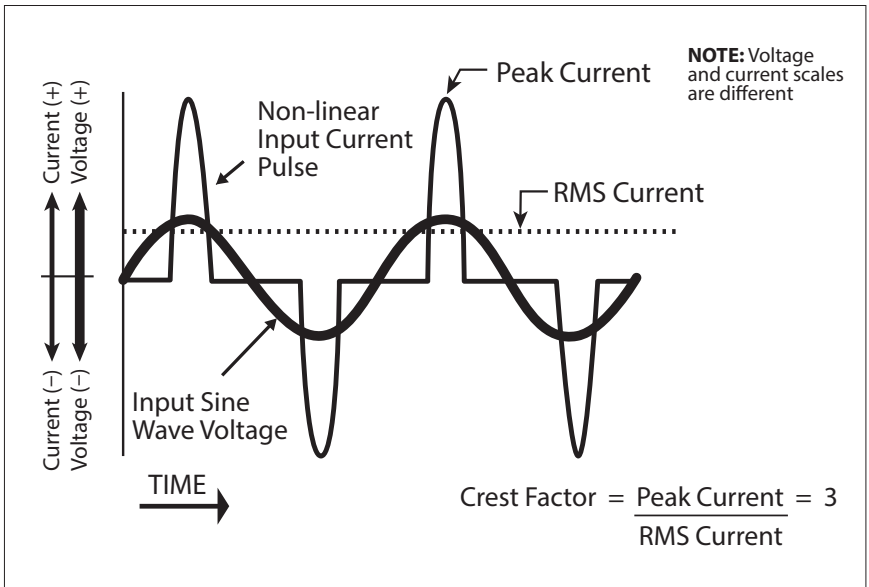

Fig. 4.2: High Crest Factor of current drawn by SMPS

SECTION 5 | Principle of Operation

5.1 GENERAL

This inverter converts 12/24 VDC battery voltage to AC voltage with an RMS (Root Mean Square) value of 120 VAC, 60 Hz RMS.

5.2 PURE SINE WAVE OUTPUT WAVEFORM

The waveform of the AC voltage is a pure Sine Waveform that is same as the waveform of Grid / Utility power (*Supplementary information on pure Sine Waveform and its advantages are discussed in Sections 2.2 to 2.4.*

Fig. 5.1 below specifies the characteristics of 120 VAC, 60 Hz pure Sine Waveform. The instantaneous value and polarity of the voltage varies cyclically with respect to time. For example, in one cycle in a 120 VAC, 60 Hz system, it slowly rises in the Positive direction from 0V to a peak Positive value " $V_{\text{peak}} = + 169.68\text{V}$ ", slowly drops to 0V, changes the polarity to Negative direction and slowly increases in the Negative direction to a peak Negative value " $V_{\text{peak}} = - 169.68\text{V}$ " and then slowly drops back to 0V. There are 60 such cycles in 1 sec. Cycles per second is called the "Frequency" and is also termed "Hertz (Hz)". The Time Period of 1 Cycle is 16.66 ms.

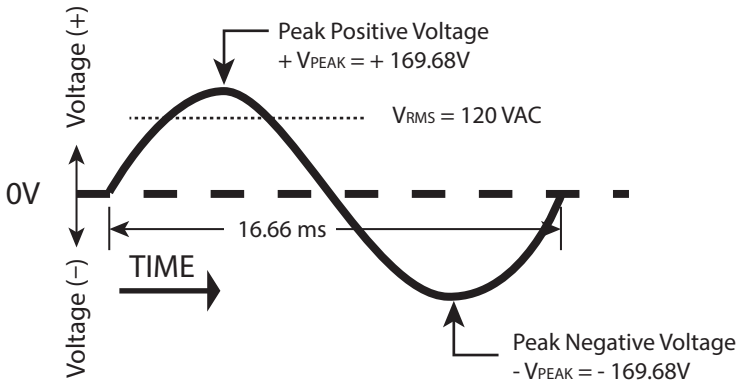

Fig. 5.1: 120 VAC, 60 Hz Pure Sine Waveform

5.3 PRINCIPLE OF OPERATION

12/24 VDC to 120 VAC conversion takes place in two stages. In the first stage, 12/24 VDC of the battery is converted to a high voltage DC using high frequency switching and Pulse Width Modulation (*PWM*) technique. In the second stage, the high voltage DC is converted to 120 VAC, 60 Hz sine wave AC again using PWM technique. This is done by using a special wave shaping technique where the high voltage DC is switched at a high frequency and the pulse width of this switching is modulated with respect to a reference sine wave.

SECTION 6 | Layout

6.1 LAYOUT

Layout of the unit is shown in Fig 6.1 below

PST-1000-12/PST-1000-24 (Front)

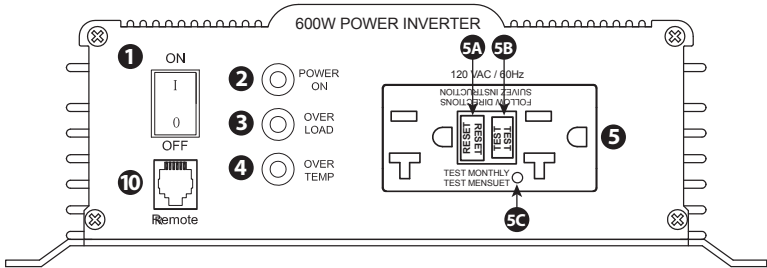

PST-1000-12/PST-1000-24 (Back)

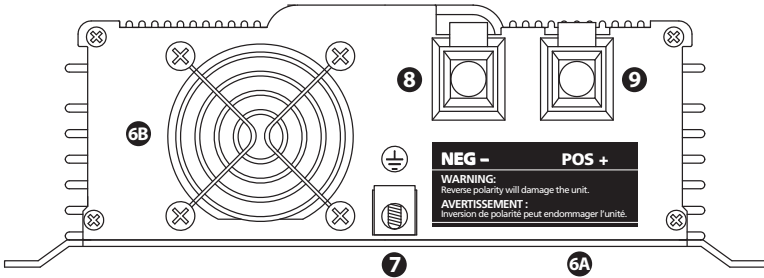

Legend

1. Two Position Rocker Switch
 - I ON – Push top end to switch ON locally
 - 0 OFF – Center to switch OFF locally
2. Green LED - Power ON
3. Red LED - Overload
4. Red LED - Over Temperature
5. NEMA5-20R Self Monitoring GFCI Duplex Outlets (Refer to Section 8.5.2)
 - 5A. Reset Button
 - 5B. Test Button
 - 5C. Dual Color (Green/Red) Status LED for GFCI
- 6A. Ventilation slots at the bottom for air suction for cooling fan
- 6B. Cooling Fan Opening for air discharge
7. Grounding Lug:
 - Wire hole diameter: 5/16"
 - Set screw: • 5/16" x 24 TPI
 - 3/8" long ; Slotted Head
8. Negative (-) DC Input Terminal
9. Positive (+) DC Input Terminal
 - Wire hole diameter: 7/16"
 - Set screw: • 5/16" x 24 TPI
 - 1/2" long ; Slotted Head
10. Modular Jack (6P6C) for RC-15A Remote Control (optional)

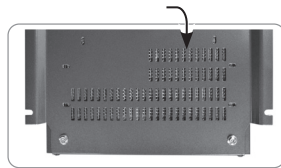

Fig. 6.1: Layout of PST-1000-12 & PST-1000-24

SECTION 7 | General Information - Battery Related



INFO

For complete information on Lead Acid Batteries and Charging Process, please visit www.samlexamerica.com > Support > White Papers > White Paper - Batteries, Chargers and Alternators.

7.1 LEAD ACID BATTERY – BASIC DESCRIPTION AND ELECTRO-CHEMICAL REACTIONS

7.1.1 A Lead Acid battery consists of a number of 2 V nominal cells (actual voltage of the cell is around 2.105 V) that are connected in series e.g. a 12 V nominal battery will have six, 2 V nominal cells in series (actual approximate voltage of the 6 cells will be 2.105 x 6 = 12.63 V). Each 2 V nominal cell in this battery consists of an independent enclosed compartment that has Positive and Negative Plates (also called Electrodes) dipped in electrolyte that is composed of diluted Sulphuric Acid.

7.1.2 A fully charged Lead Acid Battery comprises of (i) **Positive Plates:** Lead Dioxide, (ii) **Negative Plates:** Sponge Lead and (iii) **Electrolyte:** Mixture of 65% water and 35% Sulfuric Acid with Specific Gravity = 1.265 at Standard Room Temperature of 77°F / 25°C (Fully charged condition). During discharging, electro-chemical reactions lead to: (i) **At Positive Plates:** Conversion of Lead Dioxide to soft Lead Sulfate crystals, (ii) **At Negative Plates:** Conversion of Sponge Lead to soft Lead Sulfate crystals and (iii) **In Electrolyte:** Conversion of portion of Sulfuric Acid to water leading to reduction in Specific Gravity (1.120 for fully discharged condition).

7.2 TYPES OF LEAD ACID BATTERIES

7.2.1 Sealed Lead Acid (SLA) Or Valve Regulated Lead Acid (VRLA) Batteries: These can either be Gel Cell or AGM (Absorbed Glass Mat). In a Gel Cell battery, the electrolyte is in the form of a gel. In AGM (Absorbed Glass Mat) battery, the electrolyte is soaked in Glass Mat. In both these types, the electrolyte is immobile. There are no refill caps and the battery is totally sealed. Hydrogen and Oxygen released during the charging process is not allowed to escape and is recombined inside the battery through use of Recombinant Catalyst (s). Hence, there is no water loss and the batteries are maintenance free. These batteries have safety valves on each cell to release excessive pressure that may be built up inside the cell. The Gel Cell is the least affected by temperature extremes, storage at low state of charge and has a low rate of self-discharge. An AGM battery will handle overcharging slightly better than the Gel Cell.

7.2.2 Non Sealed (Vented / Flooded / Wet Cell) Lead acid Batteries: In these batteries, each individual cell compartment has a refill cap that is used to top up the cell with distilled water and to measure the specific gravity of the electrolyte using a hydrometer. When fully charged, each individual cell has a voltage of approximately 2.105 V and electrolyte specific gravity of 1.265. As the cell discharges, its voltage and specific gravity drop. Thus, a healthy, fully charged, 12 V nominal battery with each of the 6 cells

SECTION 7 | General Information - Battery Related

fully charged to 2.105 V will measure a standing voltage of 12.63 V at Standard Room Temperature of 77° F / 25° C. Also, in a healthy battery, all the individual cells will have the same voltage and same specific gravity. If there is a substantial difference in the voltages (0.2 V or higher) and specific gravities of the individual cells (0.015 or more), the cells will have to be "equalized".

7.2.3 SLI (*Starting, Lighting, and Ignition*) Batteries: Everybody is familiar with the SLI batteries that are used for automotive starting, lighting, ignition and powering vehicular accessories. SLI batteries are designed to produce high current in short bursts for cranking. This current is also called also called "Cranking Amps". SLI batteries use lots of thin plates to maximize the surface area of the plates for providing very large Cranking Amps. This allows very high starting current but causes the plates to warp when the battery is cycled. Vehicle starting typically discharges 1%-3% of a healthy SLI battery's capacity. The automotive SLI battery is not designed for repeated deep discharge where up to 80 % of the battery capacity is discharged and then recharged. If an SLI battery is used for this type of deep discharge application, its useful service life will be drastically reduced. This type of battery is not recommended for the storage of energy for inverter backup applications.

7.2.4 Deep Cycle Lead Acid Batteries: These batteries are designed with thick-plate electrodes to serve as primary power sources, to have a constant discharge rate, to have the capability to be deeply discharged up to 80 % capacity and to repeatedly accept recharging. They are marketed for use in recreation vehicles (*RV*), boats and electric golf carts – so they may be referred to as RV batteries, marine batteries or golf cart batteries.

7.3 RATED CAPACITY SPECIFIED IN AMPERE-HOUR (*Ah*)

Battery capacity "C" is specified in Ampere-hours (*Ah*). An Ampere is the unit of measurement for electrical current and is defined as a Coulomb of charge passing through an electrical conductor in one second. The Capacity "C" in Ah relates to the ability of the battery to provide a constant specified value of discharge current (also called "C-rate" - see Section 7.6) over a specified time in hours before the battery reaches a specified discharged terminal voltage (Also called "End Point Voltage") at a specified temperature of the electrolyte. As a benchmark, the automotive battery industry rates batteries at a discharge current or C-rate of C/20 Amperes corresponding to 20 Hour discharge period. The rated capacity "C" in Ah in this case will be the number of Amperes of current the battery can deliver for 20 Hours at 80°F (26.7°C) till the voltage drops to 1.75V / Cell. i.e. 10.5V for 12V battery or 21V for 24V battery. For example, a 100 Ah battery will deliver 5A for 20 Hours.

7.4 RATED CAPACITY SPECIFIED IN RESERVE CAPACITY (*RC*)

Battery capacity may also be expressed as Reserve Capacity (*RC*) in minutes typically for automotive SLI (*Starting, Lighting and Ignition*) batteries. It is the time in minutes a vehicle can be driven after the charging system fails. This is roughly equivalent to the conditions after the alternator fails while the vehicle is being driven at night with the headlights on. The battery alone must supply current to the headlights and the computer/ignition system. The assumed battery load is a constant discharge current of 25A. Reserve capacity is the time in minutes for which the battery can deliver 25 Amperes at

SECTION 7 | General Information - Battery Related

80°F (26.7°C) till the voltage drops to 1.75V / Cell i.e. 10.5V for 12V battery or 21V for 24V battery.

Approximate relationship between the two units is: **Capacity “C” in Ah = Reserve Capacity in RC minutes x 0.6**

7.5 TYPICAL BATTERY SIZES

The Table 7.1 shows details of some popular battery sizes:

BCI* Group	Battery Voltage, V	Battery Capacity, Ah
27 / 31	12	105
4D	12	160
8D	12	225
GC2**	6	220

* Battery Council International; ** Golf Cart

7.6 C-RATE OF CHARGE / DISCHARGE

7.6.1 The rate of charge / discharge of a battery is normally expressed in “C-rate” which is a *multiple* of the *numerical value* of the battery’s Ampere Hour (Ah) Capacity (C) (See Section 7.3 for information on Ampere Hour Capacity). Few examples of C-rates (2C, 1C, 0.2C etc.) for 100Ah capacity battery (C=100 Ah) are given below:

- $2C = (2 \times 100) A = 200A$ (As the battery capacity is 100 Ah, the battery will be completely discharged in 0.5 Hrs.)
- $1C = (1 \times 100) A = 100A$ (As the battery capacity is 100 Ah, the battery will be completely discharged in 1 Hr.)
- $0.2C$ (or C/5) = $(0.2 \times 100) A = 20A$ (As the battery capacity is 100 Ah, the battery will be completely discharged in 5 Hrs.)

7.6.2 Example for Determining C-rate of Charge for Particular Value of Charge Current:

- Determine the Ah capacity (C) of the battery – say 100 Ah (C=100 Ah)
- Determine the value of charge current – say 10 Amperes
- C-rate of charge at 10A = Multiple of numerical value Ampere Hour Capacity (C) = $(10 \div 100)$ C = 1/10 C or 0.1C

7.6.3 Example for Determining C-rate of Discharge for Particular Value of Discharge Current:

- Determine the Ah capacity (C) of the battery – say 100 Ah (C=100)
- Determine the value of discharge current – say 20 Amperes
- C-rate of discharge at 20A = Multiple of numerical value of Ah Capacity (C) = $(20 \div 100)$ C = 1/5 C

7.6.4 Table 7.2 gives some examples of typical C-rates of Discharge and applications:

SECTION 7 | General Information - Battery Related

TABLE 7.2 TYPICAL "C-rates" OF DISCHARGE	
C-rate of Discharge (Column 1)	Examples of C-rate of Discharge for 100 Ah capacity battery (Column 2)
2C	200A
1C	100A
C/5 or 0.2C (Inverter application)	20A
C/8 or 0.125C (UPS application)	12.5A
C/10 or 0.1C (Telecom application)	10A
C/20 or 0.05C (Automotive application)	5A
C/100 or 0.01C	1A

7.7 CHARGE / DISCHARGE CURVES TO DETERMINE STATE OF CHARGE OF LEAD ACID BATTERY BASED ON ITS TERMINAL VOLTAGE AND C-RATES OF CHARGE / DISCHARGE

7.7.1 Fig 7.1 shows examples of State of Charge / Discharge Curves for different C-rates for typical 12V / 24V Lead Acid Battery at 80°F / 26.7°C. These curves are used to determine the State of Charge / Discharge of the battery based on its terminal voltage.

The Y-Axis shows the terminal voltage of the battery. The X-Axis shows % State of Charge. % State of Discharge can be converted to % State of Charge using formula:

- % State of Charge = $(100\% - \% \text{ State of Discharge})$ e.g. 80% State of Discharge = $100\% - 80\% = 20\%$ State of Charge

7.7.2 Example of Determining State of Charge (using Fig 7.1) when Charging 12V, 100Ah Battery at C-rate of 0.1C or C/10 or 10A: Refer to Charge Curve marked C10 of the upper 4 curves marked "CHARGE". States of Charge at different battery terminal voltages will be: (a) At 15.3V = 100% charged; (b) At 14.3V = 90% charged; (c) At 13.5V = 70% charged; (d) At 12.5V = 15% charged

7.7.3 Example of Determining State of Discharge (using Fig 7.1) when Discharging 12V, 100Ah Battery at C-rate of 0.33C or C/3 or 33.3A: Refer to Charge Curve marked C3 of the lower 4 curves marked "DISCHARGE". States of Discharge at different battery terminal voltages will be: [a] At 9.5V = 100% discharged (0% charged); [b] At 10.4V = 80% discharged (20% charged); [c] At 11.5V = 28% discharged (72% charged) and [d] 11.75V = 0% discharged (100% charged)

SECTION 7 | General Information - Battery Related

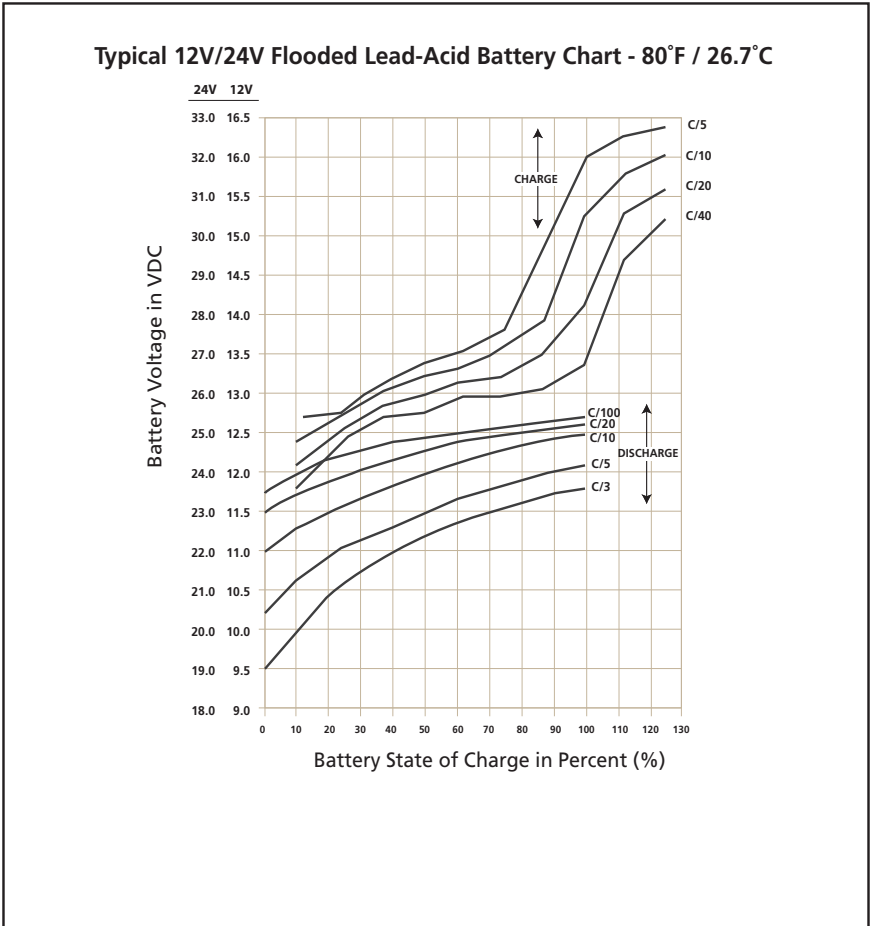

Fig 7.1 Charging / Discharging Curves for Typical 12V/24V Flooded Lead Acid Battery

7.8 REDUCTION IN USABLE CAPACITY AT HIGHER DISCHARGE RATES – TYPICAL IN INVERTER APPLICATION

As stated earlier, the Ah capacity of automotive battery is normally applicable at C-rate of $C/20$ (or $0.05C$). As the discharge rate is increased as in cases where the inverters are driving higher capacity loads, the usable Ah capacity reduces due to "Peukert Effect". This relationship is not linear but is more or less according to the Table 7.3.

SECTION 7 | General Information - Battery Related

C-rate Discharge Current	Usable Capacity (%)
C/20 or, 0.05C	100%
C/10 or, 0.10C	87%
C/8 or, 0.125C	83%
C/6 or, 0.17C	75%
C/5 or, 0.20C	70%
C/3 or, 0.34C	60%
C/2 or, 0.50C	50%
1C	40%

Table 7.3 shows that a 100 Ah capacity battery will deliver 100% (*i.e. full 100 Ah*) capacity if it is slowly discharged over 20 Hours at the rate of 5 Amperes (*50W output for a 12V inverter and 100W output for a 24V inverter*). However, if it is discharged at a rate of 50 Amperes (*500W output for a 12V inverter and 1000W output for a 24V inverter*) then theoretically, it should provide $100 \text{ Ah} \div 50 = 2$ Hours. However, Table 7.3 shows that for 2 Hours discharge rate, the capacity is reduced to 50% i.e. 50 Ah. Therefore, at 50 Ampere discharge rate (*500W output for a 12V inverter and 1000W output for a 24V inverter*) the battery will actually last for $50 \text{ Ah} \div 50 \text{ Amperes} = 1$ Hour.

7.9 STATE OF CHARGE (SOC) OF A BATTERY – BASED ON “STANDING VOLTAGE”

The “Standing Voltage” of a battery under open circuit conditions (*no charger or load connected to it*) can approximately indicate the State of Charge (SOC) of the battery. *The “Standing Voltage” is measured after disconnecting any charging device(s) and the battery load(s) and letting the battery “stand” idle for 3 to 8 hours before the voltage measurement is taken.* Table 7.4 shows the State of Charge versus Standing Voltage for a typical 12V/24V battery system at 80°F (26.7°C).

Percentage of Full Charge	Standing Voltage of Individual Cells	Standing Voltage of 12V Battery	Standing Voltage of 24AVV Battery
100%	2.105V	12.63V	25.26V
90%	2.10V	12.6V	25.20V
80%	2.08V	12.5V	25.00V
70%	2.05V	12.3V	24.60V
60%	2.03V	12.2V	24.40V
50%	2.02V	12.1V	24.20V
40%	2.00V	12.0V	24.00V
30%	1.97V	11.8V	23.60V
20%	1.95V	11.7V	23.40V
10%	1.93V	11.6V	23.20V
0%	= / < 1.93V	= / < 11.6V	= / < 23.20V

SECTION 7 | General Information - Battery Related

Check the individual cell voltages / specific gravity. If the inter cell voltage difference is more than a 0.2V, or the specific gravity difference is 0.015 or more, the cells will require equalization. Please note that only non-sealed / vented / flooded / wet cell batteries are equalized. Do not equalize sealed / VRLA type of AGM or Gel Cell Batteries.

7.10 STATE OF DISCHARGE OF A LOADED BATTERY – LOW BATTERY / DC INPUT VOLTAGE ALARM AND SHUTDOWN IN INVERTERS

Most inverter hardware estimate the State of Discharge of the loaded battery by measuring the voltage at the inverter's DC input terminals (considering that the DC input cables are thick enough to allow a negligible voltage drop between the battery and the inverter).

Inverters are provided with a buzzer alarm to warn that the loaded battery has been deeply discharged to around 80% of the rated capacity. Normally, the buzzer alarm is triggered when the voltage at the DC input terminals of the inverter has dropped to around 10.5V to 10.7V for a 12V battery or 21V to 21.4V for 24V battery at C-rate discharge current of C/5 Amps and electrolyte temp. of 80°F. The inverter is shut down if the terminal voltage at C/5 discharge current falls further to 10V for 12V battery.

The State of Discharge of a battery is estimated based on the measured terminal voltage of the battery. The terminal voltage of the battery is dependent upon the following:

- **Temperature of the battery electrolyte:** Temperature of the electrolyte affects the electrochemical reactions inside the battery and produces a Negative Voltage Coefficient – during charging / discharging, the terminal voltage drops with rise in temperature and rises with drop in temperature
- **The amount of discharging current or “C-rate”:** A battery has non linear internal resistance and hence, as the discharge current increases, the battery terminal voltage decreases non-linearly

The discharge curves in Fig. 7.1 show the % State of Charge versus the terminal voltage of typical Flooded Lead Acid Battery under different charge /discharge currents, i.e. “C-rates” and fixed temperature of 80°F. (Please note that the X-Axis of the curves shows the % of State of Charge. The % of State of Discharge will be 100% - % State of Charge).

7.11 LOW DC INPUT VOLTAGE ALARM IN INVERTERS

As stated earlier at Section 7.10, the buzzer alarm is triggered when the voltage at the DC input terminals of the inverter has dropped to around 10.5V to 10.7V for a 12V battery or 21V to 21.4V for a 24V battery at C-rate discharge current of C/5 Amps. Please note that the terminal voltage relative to a particular of State Discharge decreases with the rise in the value of the discharge current. For example, terminal voltages for a State of Discharge of 80% (State of Charge of 20%) for various discharge currents will be as given at Table 7.5 (Refer to Fig 7.1 for parameters and values shown in Table 7.5):

SECTION 7 | General Information - Battery Related

TABLE 7.5 TERMINAL VOLTAGE AND SOC OF LOADED BATTERY

Discharge Current: C-rate	Terminal Voltage at 80% State of Discharge (20% SOC)		Terminal Voltage When Completely Discharged (0% SOC)	
	12V	24V	12V	24V
C/3 A	10.45V	20.9V	09.50V	19.0V
C/5 A	10.90V	21.8V	10.30V	20.6V
C/10 A	11.50V	23.0V	11.00V	22.0V
C/20 A	11.85V	23.7V	11.50V	23.0V
C/100 A	12.15V	24.3V	11.75V	23.5V

In the example given above, the 10.5V/21.0V Low Battery / DC Input Alarm would trigger at around 80% discharged state (20% SOC) when the C-rate discharge current is C/5 Amps. However, for lower C-rate discharge current of C/10 Amps and lower, the battery will be almost completely discharged when the alarm is sounded. Hence, if the C-rate discharge current is lower than C/5 Amps, the battery may have completely discharged by the time the Low DC Input Alarm is sounded.

In view of the above, it may be seen that a fixed Low DC Input Voltage Alarm is not useful. Temperature of the battery further complicates the situation. All the above analysis is based on battery electrolyte temperature of 80°F. The battery capacity varies with temperature. Battery capacity is also a function of age and charging history. Older batteries have lower capacity because of shedding of active materials, sulfation, corrosion, increasing number of charge / discharge cycles etc. Hence, the State of Discharge of a battery under load cannot be estimated accurately. However, the low DC input voltage alarm function is designed to protect the inverter from excessive current drawn at the lower voltage.

7.12 LOW DC INPUT VOLTAGE SHUT-DOWN IN INVERTERS

As explained above at Section 7.10, at around 80% State of Discharge of the battery at C-rate discharge current of around C/5 Amps, the Low DC Input Voltage Alarm is sounded at around 10.5V to 10.7V for a 12V battery or, at around 21V to 21.4V for 24V battery to warn the user to disconnect the battery to prevent further draining of the battery. If the load is not disconnected at this stage, the batteries will be drained further to a lower voltage and to a completely discharged condition that is harmful for the battery and for the inverter.

Inverters are normally provided with a protection to shut down the output of the inverter if the DC voltage at the input terminals of the inverter drops below a threshold of around 10V for a 12V battery or, 20V for 24V battery. Referring to the Discharge Curves given in Fig 7.1, the State of Discharge for various C-rate discharge currents for battery voltage of 10V/ 20V is as follows: (Please note that the X-Axis of the curves shows the % of State of Charge. The % of State of Discharge will be 100% - % State of Charge):

- 85% State of Discharge (15% State of Charge) at very high C-rate discharge current of C/3 Amps.
- 100% State of Discharge (0% State of Charge) at high C-rate discharge current of C/5 Amps.
- 100% discharged (0% State of charge) at lower C-rate Discharge current (of C/10 Amps

SECTION 7 | General Information - Battery Related

It is seen that at DC input voltage of 10V/ 20V, the battery is completely discharged for C-rate discharge current of C/5 and lower.

In view of the above, it may be seen that a fixed Low DC Input Voltage Shutdown is not useful. Temperature of the battery further complicates the situation. All the above analysis is based on battery electrolyte temperature of 80°F. The battery capacity varies with temperature. Battery capacity is also a function of age and charging history. Older batteries have lower capacity because of shedding of active materials, sulfation, corrosion, increasing number of charge / discharge cycles etc. Hence, the State of Discharge of a battery under load cannot be estimated accurately. However, the low DC input voltage alarm and shutdown function is designed to protect the inverter from excessive current drawn at the lower voltage.

7.13 USE OF EXTERNAL PROGRAMMABLE LOW VOLTAGE DISCONNECTS

The above ambiguity can be removed by using an external, programmable Low Voltage Disconnect where more exact voltage threshold can be set to disconnect the battery based on the actual application requirements. Please consider using the following Programmable Low Battery Cut-off / "Battery Guard" Models manufactured by Samlex America, Inc., www.samlexamerica.com

- BG-40 (40A) – For up to 400W, 12V inverter or 800W, 24V Inverter
- BG-60 (60A) - For up to 600W, 12V inverter or 1200W, 24V Inverter
- BG-200 (200A) - For up to 2000W, 12V inverter or 4000W, 24V Inverter

7.14 DEPTH OF DISCHARGE OF BATTERY AND BATTERY LIFE

The more deeply a battery is discharged on each cycle, the shorter the battery life. Using more batteries than the minimum required will result in longer life for the battery bank. A typical cycle life chart is given in the Table 7.6:

Depth of Discharge % of Ah Capacity	Cycle Life of Group 27 /31	Cycle Life of Group 8D	Cycle Life of Group GC2
10	1000	1500	3800
50	320	480	1100
80	200	300	675
100	150	225	550

NOTE: It is recommended that the depth of discharge should be limited to 50%.

7.15 INSTALLING BATTERIES - SERIES AND PARALLEL CONNECTION

Batteries are normally available in voltages of 2V, 6V and 12V and with different Ah capacities. A number of individual batteries can be connected in series and in parallel to form a bank of batteries with the desired increased voltage and capacity.

SECTION 7 | General Information - Battery Related

7.15.1 Series Connection

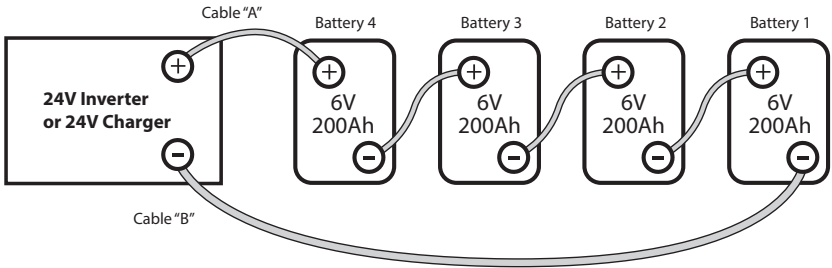

Fig 7.2 Series Connection

When two or more batteries are connected in series, their voltages add up but their Ah capacity remains the same. Fig. 7.2 shows 4 pieces of 6V, 200 Ah batteries connected in series to form a battery bank of 24V with a capacity of 200 Ah. The Positive terminal of battery 4 becomes the Positive terminal of the 24V bank. The Negative terminal of battery 4 is connected to the Positive terminal of battery 3. The Negative terminal of battery 3 is connected to the Positive terminal of battery 2. The Negative terminal of battery 2 is connected to the Positive terminal of battery 1. The Negative terminal of battery 1 becomes the Negative terminal of the 24V battery bank.

7.15.2 Parallel Connection

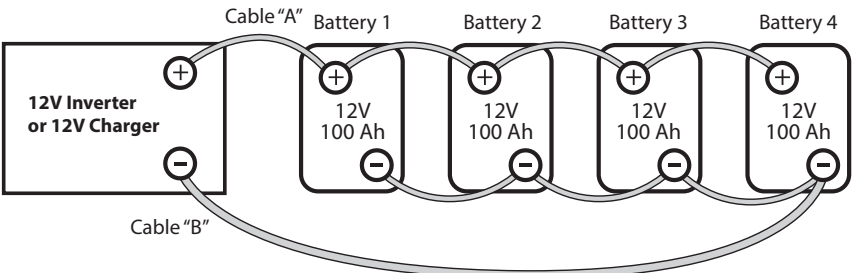

Fig 7.3 Parallel Connection

When two or more batteries are connected in parallel, their voltage remains the same but their Ah capacities add up. Fig. 7.3 shows 4 pieces of 12V, 100 Ah batteries connected in parallel to form a battery bank of 12V with a capacity of 400 Ah. The four Positive terminals of Batteries 1 to 4 are paralleled (*connected together*) and this common Positive connection becomes the Positive terminal of the 12V bank. Similarly, the four Negative terminals of Batteries 1 to 4 are paralleled (*connected together*) and this common Negative connection becomes the Negative terminal of the 12V battery bank.

SECTION 7 | General Information - Battery Related

7.15.3 Series – Parallel Connection

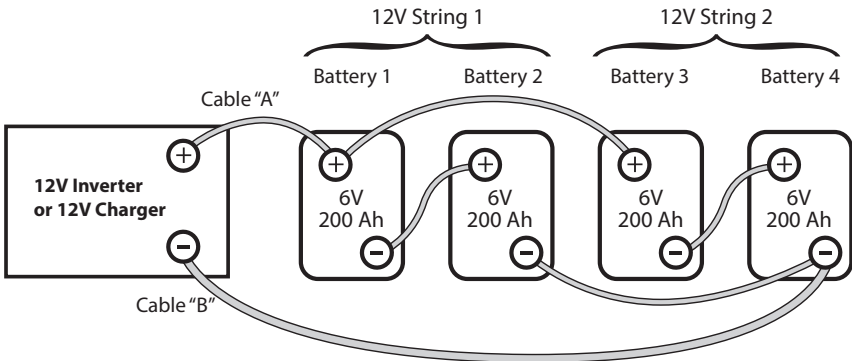

Fig. 7.4 Series-Parallel Connection

Figure 7.4 shows a series – parallel connection consisting of four 6V, 200 AH batteries to form a 12V, 400 Ah battery bank. Two 6V, 200 Ah batteries, Batteries 1 and 2 are connected in series to form a 12V, 200 Ah battery (*String 1*). Similarly, two 6V, 200 Ah batteries, Batteries 3 and 4 are connected in series to form a 12V, 200 Ah battery (*String 2*). These two 12V, 200 Ah Strings 1 and 2 are connected in parallel to form a 12V, 400 Ah bank.

7.15.4 Wiring Order in Parallel Connection of Batteries



CAUTION!

When 2 or more batteries / battery strings are connected in parallel and are then connected to inverter/charger (See Figs 7.3 and 7.4), attention should be paid to the manner in which the inverter/charger is connected to the battery bank. Please ensure that if the Positive output cable of the inverter/charger (*Cable "A"*) is connected to the Positive battery post of the first battery (*Battery 1 in Fig 7.3*) or to the Positive battery post of the first battery string (*Battery 1 of String 1 in Fig. 7.4*), then the Negative output cable of the inverter/charger (*Cable "B"*) should be connected to the Negative battery post of the last battery (*Battery 4 as in Fig. 7.3*) or to the Negative Post of the last battery string (*Battery 4 of Battery String 2 as in Fig. 7.4*). This connection ensures the following:

- The resistances of the interconnecting cables will be balanced.
- All the individual batteries / battery strings will see the same series resistance.
- All the individual batteries will charge/discharge at the same charging/ discharging current and thus, will be charged/discharged to the same state at the same time.
- None of the batteries will see an overcharge/overdischarge condition.

SECTION 7 | General Information - Battery Related

If the Positive output cable of the inverter/charger (*Cable "A"*) is connected to the Positive battery post of the first battery (*Battery 1 in Fig. 7.3*) or to the Positive battery post of the first battery string (*Battery 1 of String 1 in Fig. 7.4*), and the Negative output cable of the inverter/charger (*Cable "B"*) is connected to the Negative battery post of the first battery (*Battery 1 as in Fig. 7.3*) or to the Negative Post of the first battery string (*Battery 1 of Battery String 1 as in Fig 7.4*), the following abnormal conditions will result:

- The resistances of the connecting cables will not be balanced.
- The individual batteries will see different series resistances.
- All the individual batteries will be charged/discharged at different charging/discharging current and thus, will reach fully charged/discharged state at different times.
- The battery with lower series resistance will take shorter time to charge/dischARGE as compared to the battery which sees higher series resistance and hence, will experience over charging/over discharging and its life will be reduced.



ATTENTION!

Quand il y a 2 batteries/fils de batterie ou plus qui sont liés en parallèle et branché à la fois, à un chargeur (Voir Figs. 7.3 et 7.4), il faut faire attention à la manière dont le chargeur est branché à la banque de batterie. Veuillez assurer que le câble positif de sortie du chargeur de batterie (Câble A) est lié à la borne positive de la première batterie (La batterie 1 dans la Fig. 7.3) ou à la borne positive de batterie qui est liée au premier fil (Le fil 1 et la batterie 1, Fig 7.4), et puis le câble négatif de sortie du chargeur de batterie (Câble B) est lié à la borne négative de la dernière batterie (La Batterie 4 dans la Fig. 7.3) ou à la borne négative de batterie qui est liée au dernier fil (Le fil 2 et La batterie 4 dans la Fig. 7.4). Cette connexion assure la suivante:

- Les résistances des câbles interconnectés seront équilibrées
- Tous les batteries/ fils de batterie dans la série auront la même résistance
- Toutes les batteries individuelles vont recharger au même courant, ainsi elles seront rechargées à l'état pareille, au même temps
- Aucune des batteries auront une condition de surcharge.

Si le câble positif de sortie du chargeur de batterie (Câble A) est lié à la borne positive de la première batterie (La batterie 1 dans la Fig. 7.3) ou à la borne positive de batterie qui est liée au premier fil (Le fil 1 et La Batterie 1, Fig 7.4), et puis le câble négatif de sortie du chargeur de batterie (Câble B) est lié à la borne négative de la première batterie (La batterie 1 dans la Fig. 7.3) ou à la borne négative de batterie qui est liée au premier fil (Le fil 1 de La Batterie 1 dans la Fig. 7.4), les conditions anormales résulteront:

SECTION 7 | General Information - Battery Related

- Les résistances des câbles interconnectés seront pas équilibrées
- Tous les batteries/ fils de batterie dans la série n'auront pas la même résistance
- Toutes les batteries individuelles vont recharger à des courants différentes, ainsi elles atteindront un état de rechargement complet mais en décalage.
- La batterie ayant le moins de résistance dans la série prendrait moins de temps pour être rechargée comparé aux autres batteries. Alors elle serait surchargée et, en conséquence aurait une vie plus courte.

7.16 SIZING THE INVERTER BATTERY BANK

One of the most frequently asked questions is, "how long will the batteries last?" This question cannot be answered without knowing the size of the battery system and the load on the inverter. Usually this question is turned around to ask "How long do you want your load to run?", and then specific calculation can be done to determine the proper battery bank size. There are a few basic formulae and estimation rules that are used:

1. Active Power in Watts (W) = Voltage in Volts (V) x Current in Amperes (A) x Power Factor.
2. For an inverter running from a 12V battery system, the approximate DC current required from the 12V batteries is the AC power delivered by the inverter to the load in Watts (W) divided by 10 & for an inverter running from a 24V battery system, the approximate DC current required from the 24V batteries is the AC power delivered by the inverter to the load in Watts (W) divided by 20.
3. Energy required from the battery = DC current to be delivered (A) x Time in Hours (H).

The first step is to estimate the total AC watts (W) of load(s) and for how long the load(s) will operate in hours (H). The AC watts are normally indicated in the electrical nameplate for each appliance or equipment. In case AC watts (W) are not indicated, Formula 1 given above may be used to calculate the AC watts. The next step is to estimate the DC current in Amperes (A) from the AC watts as per Formula 2 above. An example of this calculation for a 12V inverter is given below:

Let us say that the total AC Watts delivered by the inverter = 1000W.

Then, using Formula 2 above, the approximate DC current to be delivered by the 12V batteries = $1000W \div 10 = 100$ Amperes, or by 24V batteries = $1000W \div 20 = 50A$.

Next, the energy required by the load in Ampere Hours (Ah) is determined.

For example, if the load is to operate for 3 hours then as per Formula 3 above, the energy to be delivered by the 12V batteries = 100 Amperes x 3 Hours = 300 Ampere Hours (Ah), or by the 24V batteries = $50A$ x 3 Hrs = 150 Ah.

SECTION 7 | General Information - Battery Related

Now, the capacity of the batteries is determined based on the run time and the usable capacity.

From Table 7.3 "Battery Capacity versus Rate of Discharge", the usable capacity at 3 Hour discharge rate (C/3) is 60%. Hence, the actual capacity of the 12V batteries to deliver 300 Ah will be equal to: $300 \text{ Ah} \div 0.6 = 500 \text{ Ah}$, and the actual capacity of the 24V battery to deliver 150 Ah will be equal to $150 \text{ Ah} \div 0.6 = 250 \text{ Ah}$

And finally, the actual desired rated capacity of the batteries is determined based on the fact that normally only 80% of the capacity will be available with respect to the rated capacity due to non availability of ideal and optimum operating and charging conditions. So the final requirements will be equal to:

FOR 12V BATTERY:

$500 \text{ Ah} \div 0.8 = 625 \text{ Ah}$ (*note that the actual energy required by the load was 300 Ah*).

FOR 24V BATTERY:

$250 \text{ Ah} \div 0.8 = 312.5 \text{ Ah}$ (*note that the actual energy required was 150 Ah*).

It will be seen from the above that the final rated capacity of the batteries is almost 2 times the energy required by the load in Ah. Thus, as a Rule of Thumb, the Ah capacity of the batteries should be twice the energy required by the load in Ah.

7.17 CHARGING BATTERIES

Batteries can be charged by using good quality AC powered battery charger or from alternative energy sources like solar panels, wind or hydro systems. Make sure an appropriate Battery Charge Controller is used. It is recommended that batteries may be charged at 10% to 20% of their Ah capacity (*Ah capacity based on 20 Hr Discharge Rate*). Based on the application, batteries may be charged using 2-Stage / 3-Stage / 4-Stage Charging Profiles as follows:

- **Float Application Charging (2-Stage)**
Stage 1 (*Bulk Stage at constant current*) → Stage 2 (*Absorption Stage at constant voltage. May also be called Float Stage in some applications*).
- **Normal Charging (3-Stages)**
Stage 1 (*Bulk Stage at constant current*) → Stage 2 (*Absorption Stage at constant voltage*) → Stage 3 (*Float Stage at constant voltage*).
- **Equalization Charging (4-Stages)**
Stage 1 (*Bulk Stage at constant current*) → Stage 2 (*Absorption Stage at constant voltage*) → Stage 3 (*Equalization Stage at constant voltage*) → Stage 4 (*Float Stage at constant voltage*).

SECTION 8 | Installation



WARNING!

1. Before commencing installation, please read the safety instructions explained in the Section titled "Safety Instructions" on page 3.
2. It is recommended that the installation should be undertaken by a qualified, licensed / certified electrician.
3. Various recommendations made in this manual on installation will be superseded by the National / Local Electrical Codes related to the location of the unit and the specific application.



MISE EN GARDE!

1. Avant de faire une installation, veuillez lire les «Consignes de Sécurité» à la page 3.
2. On recommande que l'installation soit faite par un(e) électricien(ne) CERTIFIÉ(E).
3. Il y a plusieurs consignes trouvées dans ce guide qui ne sont pas toujours applicables si une norme nationale ou locale en prend place, concernant par exemple l'endroit d'installation ou à l'usage de l'appareil. Quelques exemples sont écrites ci-dessous.

8.1 LOCATION OF INSTALLATION

Please ensure that the following requirements are met:

Working Environment: Indoor use

Cool: Heat is the worst enemy of electronic equipment. Hence, please ensure that the unit is installed in a cool area that is also protected against heating effects of direct exposure to the sun or to the heat generated by other adjacent heat generating devices.

Well ventilated: The unit is cooled by convection and by forced air-cooling by temperature controlled fan. The fan sucks cool air from air intake openings on the bottom (6A, Fig 6.1) and expels hot air through the exhaust openings next to the fan (6B, Fig 6.1). To avoid shut down of the inverter due to over temperature, do not cover or block these intake / exhaust openings or install the unit in an area with limited airflow. Keep a minimum clearance of 10" around the unit to provide adequate ventilation. If installed in an enclosure, openings must be provided in the enclosure, directly opposite to the air intake and exhaust openings of the inverter.

Dry: There should be no risk of condensation, water or any other liquid that can enter or fall on the unit.

SECTION 8 | Installation

Clean: The area should be free of dust and fumes. Ensure that there are no insects or rodents. They may enter the unit and block the ventilation openings or short circuit electrical circuits inside the unit.

Protection against fire hazard: The unit is not ignition protected and should not be located under any circumstance in an area that contains highly flammable liquids like gasoline or propane as in an engine compartment with gasoline-fueled engines. Do not keep any flammable / combustible material (*i.e., paper, cloth, plastic, etc.*) near the unit that may be ignited by heat, sparks or flames.

Closeness to the battery bank: Locate the unit as close to the battery bank as possible to prevent excessive voltage drop in the battery cables and consequent power loss and reduced efficiency. However, the unit should not be installed in the same compartment as the batteries (*flooded or wet cell*) or mounted where it will be exposed to corrosive acid fumes and flammable Oxygen and Hydrogen gases produced when the batteries are charged.

The corrosive fumes will corrode and damage the unit and if the gases are not ventilated and allowed to collect, they could ignite and cause an explosion.

Accessibility: Do not block access to the front panel. Also, allow enough room to access the AC receptacles and DC wiring terminals and connections, as they will need to be checked and tightened periodically.

Preventing Radio Frequency Interference (RFI): The unit uses high power switching circuits that generate RFI. This RFI is limited to the required standards. Locate any electronic equipment susceptible to radio frequency and electromagnetic interference as far away from the inverter as possible. *Read Section 3 "Limiting Electromagnetic Interference (EMI)" for additional information.*

8.2 MOUNTING ORIENTATION

The unit has air intake and exhaust openings for the cooling fan. It has to be mounted in such a manner so that small objects should not be able to fall easily into the unit from these openings and cause electrical / mechanical damage. Also, the mounting orientation should be such that if the internal components overheat and melt / dislodge due to a catastrophic failure, the melted / hot dislodged portions should not be able to fall out of the unit on to a combustible material and cause a fire hazard. The size of openings has been limited as per the safety requirements to prevent the above possibilities when the unit is mounted in the recommended orientations. In order to meet the regulatory safety requirements, the mounting has to satisfy the following requirements:

SECTION 8 | Installation

- Mount on a non-combustible material.
- The mounting surface should be able to support the weight of the unit
- Mount horizontally on a horizontal surface - above a horizontal surface (e.g. table top or a shelf).
- Mount horizontally on a vertical surface – The unit can be mounted on a vertical surface (like a wall) with the fan axis horizontal (fan opening facing left or right).



WARNING!

Mounting the unit vertically on a vertical surface is NOT allowed (fan opening facing up or down). As explained above, this is to prevent falling of objects into the unit through the fan opening when the fan opening faces up. If fan opening faces down, hot damaged component may fall out.



MISE EN GARDE!

Monter l'unité verticalement sur une surface verticale EST INTERDIT (c.a.d. que les ouvertures sont mise sur l'axe vertical). Comme c'est expliqué au-dessus, c'est pour empêcher une chute d'objet dans les ouvertures de ventilateurs (lorsqu'elles sont au-dessus) ou que des composants endommagés tombent par terre (lorsqu'elles sont en-bas).

SECTION 8 | Installation

8.3 OVERALL DIMENSIONS

Overall dimensions and location of mounting slots are shown in Fig. 8.1 below:

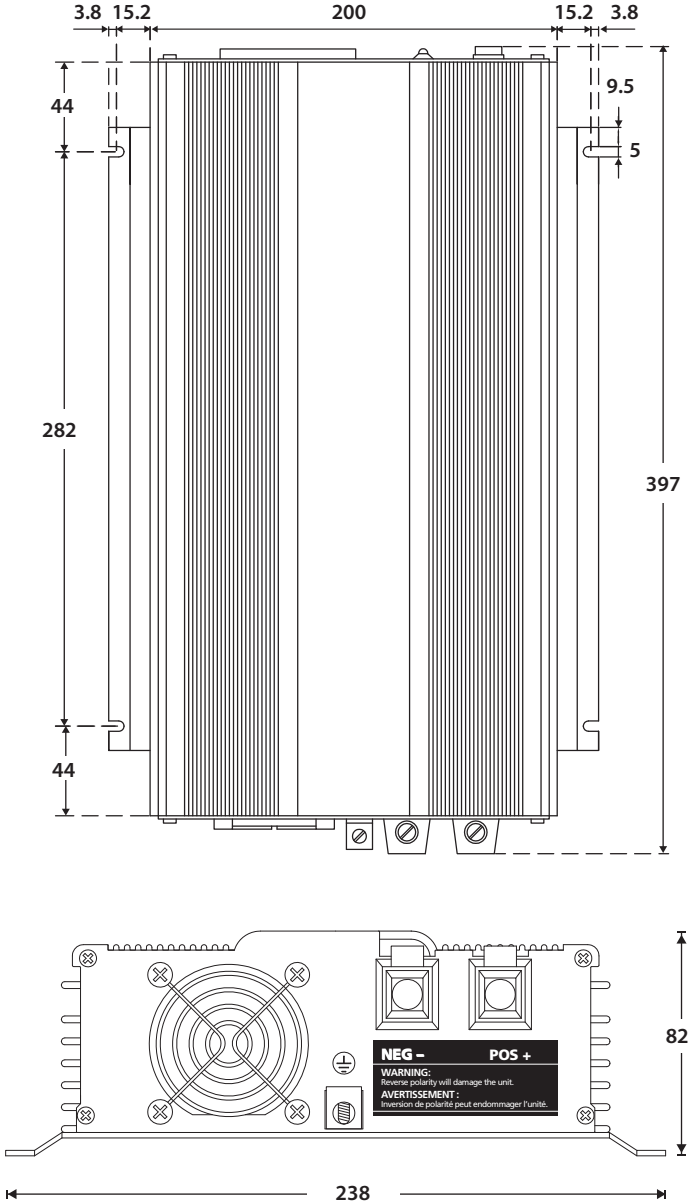

Fig. 8.1 PST-1000 Overall Dimensions & Mounting Slots (NOTE: Dimensions in mm)

SECTION 8 | Installation

8.4 DC SIDE CONNECTIONS

8.4.1 Preventing DC Input Over Voltage

It is to be ensured that the DC input voltage of this unit does not exceed 16.5 VDC for PST-1000-12 or 33.0 VDC for PST-1000-24 to prevent permanent damage to the unit. Please observe the following precautions:

- Ensure that the maximum charging voltage of the external battery charger / alternator / solar charge controller does not exceed 16.5 VDC for PST-1000-12 or 33V for PST-1000-24
- When using Diversion Charge Control Mode in a Charge Controller, the solar / wind / hydro source is directly connected to the battery bank. In this case, the Controller will divert excess current to an external load. As the battery charges, the diversion duty cycle will increase. When the battery is fully charged, all the source energy will flow into the diversion load if there are no other loads. The Charge Controller will disconnect the diversion load if the current rating of the Controller is exceeded. Disconnection of the diversion load may damage the battery as well as the inverter or other DC loads connected to the battery due to high voltages generated during conditions of high winds (*for wind generators*), high water flow rates (*for hydro generators*). It is, therefore, to be ensured that the diversion load is sized correctly to prevent the above over voltage conditions.
- Do not use solar panel/ array to directly charge the battery bank connected to the inverter. Use appropriate Charge Controller between the solar panel/ array and the battery bank. Using solar panel/ array to directly charge the battery will lead to over voltage shutdown of the inverter and possible damage due to battery voltage rising close to the level of the open circuit voltage of the solar panel(s) when the battery is fully charged and is in Float Stage (under this condition, the battery will be drawing very low trickle charge current & voltage of the unregulated solar panel(s) will rise close to its Open Circuit Voltage).
- Do not connect this unit to a battery system with a voltage higher than the rated nominal battery input voltage of the unit.

8.4.2 Preventing Reverse Polarity on the Input Side



CAUTION!

Damage caused by reverse polarity is not covered by warranty! When making battery connections on the input side, make sure that the polarity of battery connections is correct (Connect the Positive of the battery to the Positive terminal of the unit and the Negative of the battery to the Negative terminal of the unit). If the input is connected in reverse polarity, DC fuse(s) inside the inverter will blow and may also cause permanent damage to the inverter.



ATTENTION!

Des dégâts causés par un inversement des polarités ne sont pas couverts par la garantie! Quand vous faites des connexions à la batterie du côté d'entrée, veuillez assurer que les polarités sont mises du bon côté (Liez le Positif de la batterie à la borne Positive de l'appareil et le Négatif de la batterie à la borne Négative de l'appareil). Si les polarités de l'entrée sont mises à l'envers, le(s) fusible(s) CC dans l'onduleur va/vont s'exploser et pourrait causer des dégâts permanents à l'onduleur.

SECTION 8 | Installation

8.4.3 Connection from the Batteries to the DC Input Side of the Unit – Cable and External Fuse Sizes



WARNING!

The input section of the inverter has large capacitors connected across the input terminals. As soon as the DC input connection loop (Battery (+) terminal ► External fuse ► Positive input terminal of the inverter ► Negative input terminal of the inverter ► Battery (-) terminal) is completed, these capacitors will start charging and the unit will momentarily draw very heavy current that will produce sparking on the last contact in the input loop even when the ON/OFF switch on the inverter is in the OFF position. Ensure that the external fuse is inserted only after all the connections in the loop have been completed so that the sparking is limited to the fuse area.



MISE EN GARDE!

La section d'entrée de l'onduleur a des condensateurs de grande valeur qui sont connectés aux bornes d'entrée. Tant que la boucle de connexion d'entrée CC (la borne (+) de la batterie ► le fusible externe ► la borne d'entrée positive de l'onduleur ► la borne d'entrée négative de l'onduleur ► la borne (-) de la batterie) soit complet, les condensateurs commenceront à recharger. L'appareil prendra un courant fort brièvement pour s'alimenter qui va produire une étincelle sur le dernier contact du boucle d'entrée même si l'interrupteur ON/OFF du l'onduleur est dans la position OFF. Assurez que le fusible externe est insérer seulement après que toutes les connexions sont faites dans le boucle pour que des étincelles se produisent seulement à l'endroit du fusible.

The flow of electric current in a conductor is opposed by the resistance of the conductor. The resistance of the conductor is directly proportional to the length of the conductor and inversely proportional to its cross-section (*thickness*). The resistance in the conductor produces undesirable effects of voltage drop and heating. Thus, thicker and shorter conductors are desirable.

The size (*thickness / cross-section*) of the conductors is designated by AWG (American Wire Gauge). Please note that a smaller AWG # denotes a thicker size of the conductor up to AWG #1. Wires thicker than AWG #1 are designated AWG 1/0, AWG 2/0, AWG 3/0 and so on. In this case, increasing AWG # denotes thicker wire. Conductors thicker than AWG#4/0 are sized in MCM/ kcmil. Table 8.1 gives resistance of cable in Ohm (Ω) per ft at 25°C for battery cable sizing.

SECTION 8 | Installation

WIRE SIZE, AWG	RESISTANCE IN OHM (Ω) PER FOOT AT 25°C / 77°F
AWG#2	0.000159 Ω per Foot
AWG#1/0	0.000096 Ω per Foot
AWG#2/0	0.000077 Ω per Foot
AWG#4/0	0.000050 Ω per Foot

Conductors are protected with insulating material rated for specific temperature e.g. 105°C/221°F. As current flow produces heat that affects insulation, there is a maximum permissible value of current (*called "Ampacity"*) for each size of conductor based on temperature rating of its insulation. The insulating material of the cables will also be affected by the elevated operating temperature of the terminals to which these are connected. Ampacity of cables is based on UL-458 and the National Electrical Code (NEC)-2014. Please see details given under "Notes for Table 8.2".

The DC input circuit is required to handle very large DC currents and hence, the size of the wires and connectors should be selected to ensure minimum voltage drop between the battery and the inverter. Thinner wires and loose connections will result in poor inverter performance and will produce abnormal heating leading to risk of insulation melt down and fire. Normally, the thickness of the wire should be such that the voltage drop due to the current & the resistance of the length of the wire should be less than 2%. Use oil resistant, multi- stranded copper wire wires rated at 90°C minimum. Do not use aluminum wire as it has higher resistance per unit length. Wires can be bought at a marine / welding supply store.

Effects of low voltage on common electrical loads are given below:

- **Lighting circuits - Incandescent and Quartz Halogen:** A 5% voltage drop causes an approximate 10% loss in light output. This is because the bulb not only receives less power, but the cooler filament drops from white-hot towards red-hot, emitting much less visible light.
- **Lighting circuits - Fluorescent:** Voltage drop causes a nearly proportional drop in light output.
- **AC induction motors:** These are commonly found in power tools, appliances, well pumps etc. They exhibit very high surge demands when starting. Significant voltage drop in these circuits may cause failure to start and possible motor damage.
- **PV battery charging circuits:** These are critical because voltage drop can cause a disproportionate loss of charge current to charge a battery. A voltage drop greater than 5% can reduce charge current to the battery by a much greater percentage.

8.4.4 Fuse Protection In Battery Circuits

A battery is an unlimited source of current. Under short circuit conditions, a battery can supply thousands of Amperes of current. If there is a short circuit along the length of the

SECTION 8 | Installation

cables that connects the battery to the inverter, thousands of Amperes of current can flow from the battery to the point of shorting and that section of the wire will become red-hot, the insulation will melt and the cable will ultimately break. This interruption of very high current will generate a hazardous, high temperature, high-energy arc with accompanying high-pressure wave that may cause fire, damage nearby objects and cause injury. To prevent occurrence of hazardous conditions under short circuit conditions, an appropriate fuse should be used in the battery circuit that will limit the current, blow in a very short time and quench the arc in a safe manner. For this purpose, UL Class T fuse or equivalent with Ampere Interrupting Capacity (AIC) of at least 10,000A should be used (*As per UL Standard 248-15*). This special purpose current limiting, very fast acting fuse will blow in less than 8 ms under short circuit conditions. Appropriate capacity of the above Class T fuse should be installed within 7" / 178mm of the battery Plus (+) Terminal. The fuse will require a corresponding fuse holder.

MRBF-XXX Series fuses made by Cooper Bussmann may also be used. These fuses comply with ISO-8820-6 for road vehicles.



WARNING!

Use of an appropriately sized external fuse as described above is mandatory to provide safety against fire hazard due to accidental short circuit in the battery wires. Please note that the DC side fuse(s) inside the unit are designed to provide protection to the internal components of the inverter. These fuses will NOT blow if there is an external short circuit along the length of wires connecting the battery and the inverter.



MISE EN GARDE!

Il est obligatoire d'utiliser un fusible de la bonne taille (*comme décrit au-dessus*), afin de réduire la risque d'incendie à cause d'un court-circuit accidentale des fils de batterie. Veuillez noter que des fusibles de côté CC dans l'unité sont conçus pour protéger les composants internes de l'onduleur. Ces fusibles vont pas s'explorer s'il y a un court-circuit sur la longueur des câbles connectant la batterie à l'onduleur.

8.4.5 Recommended Sizes of Battery Cables and Fuses

Sizes of cables and fuses are shown in Table 8.2. Sizing is based on safety considerations specified in UL-458, NEC-2014 and ISO-10133. Please refer to "Notes for Table 8.2" for details.

SECTION 8 | Installation

Table 8.2 Recommended Sizing of Battery Cables and External Battery Side Fuse

Model No.	Rated Continuous DC Input Current (See Note 1)	Minimum Ampacity of cable as per NEC (See Note 2)	External Battery Fuse Size (Based on Column 2) (See Note 3)	Minimum cable size (See Note 4)			Part No. of Recommended Samlex America Inverter Installation Kit (See Note 5)
				3 ft / 0.91M	6 ft / 1.83M	10 ft / 3.05M	
(1)	(2)	(3)	(4)	(5)	(6)	(7)	(8)
PST-1000-12	160A	200A	160A	AWG#2	AWG#1/0	AWG#3/0	DC-2000-KIT
PST-1000-24	80A	100A	80A	AWG#6	AWG#6	AWG#4	DC-1000-KIT

NOTES FOR TABLE 8.2

- 1) Column 2 indicates the value of the rated continuous DC input current drawn from the battery. The overall current capacity of the internal DC input fusing is the same as this value.
- 2) Column 3 indicates minimum NEC Ampacity for sizing of conductors. NEC Ampacity is not less than 125% of the rated continuous DC input current (Column 2) - Refer to NEC-2014 (*National Electrical Code*) - Section 215.2(A)(1)(a) for Feeder Circuits.
- 3) Column 4 indicates the size of external fuse in the battery circuit. It is mandatory to install this fuse within 7" of the battery Positive terminal to protect the battery cables against short circuit. Amp rating of the fuse is based on the following considerations:
 - a) Not less than the Rated Continuous DC Input Current (Column 2)
 - b) Closest Standard Ampere Rating of Fuse has been used - Refer to NEC-2014 (National Electrical Code) - Section 240.6(A)
 - c) Where Standard Fuse Rating does not match the required Ampacity (Column 2), the next higher Standard Rating of the fuse has been used - Refer to NEC-2014 (National Electrical Code) - Section 240.4(B)
 - d) **Type of fuse:** Fast-acting, Current Limiting, UL Class T (UL Standard 248-15) or equivalent. MRBF-XXX Series fuses made by Cooper Bussmann may also be used. These fuses comply with ISO-8820-6 for road vehicles.
- 4) Columns 5 to 7 indicate minimum cable conductor size that is based on the following 2 considerations. **Thicker conductor out of the following 2 considerations has been chosen:**
 - a) As per guidelines in ISO 10133 for 105°C cable insulation and cable running in free air. Conductor size is based on:
 - (i) NEC Ampacity specified at Column 3,
 - (ii) Copper conductor with temperature rating of 105°C/221°F and
 - (iii) Ambient temperature of 30°C / 86°F

SECTION 8 | Installation

b) Voltage drop across the length of cables limited to 2% of 12V / 24V.

i) Voltage drop has been calculated by multiplying the Rated Continuous DC Input Current (Column 2) and the resistance of the total length of Copper conductor (**the total length of conductor has been taken as 2 times the running distance between the unit and the battery to cover 2 lengths of Positive and Negative cable conductors**).

ii) Resistance of the cable is based on Table 8.1.

5) Samlex America, Inc. makes 5 Models of generic / universal Inverter Installation Kits based on 10 ft distance between the battery and the inverter and up to 3%-5% voltage drop. These kits are designed to meet installation requirements of a wide power range from 600W to 3500W for 12V inverters and from 1200W to 7000W for 24V inverters. Please note that cable sizing recommended in Columns 5 to 7 is based on 2% voltage drop for improved efficiency for distances of 3 ft, 6 ft and 10 ft. Hence, the cable sizing for the Installation Kits shown in Column 8 may not exactly match the sizing given in Columns 5 to 7.

Fuse in the battery circuit is primarily required for protection against short circuit in the battery cable run. The size of this fuse has to be equal to or larger than the rated continuous DC input current of the inverter at Column (2). Further, the Amp rating of the fuse used for protecting a battery cable against short circuit has to be lower than the Ampacity of the cable so that the fuse blows before the cable insulation is damaged due to overheating as a result of fault current higher than the Ampacity of the cable. The Amp ratings of fuses provided with the Inverter Installation Kits are lower than the Ampacity of cables provided with the Kit.

The Kits come with 10ft length of cables to cover battery to inverter distance of up to 10 ft. If the actual cable routing distance from the battery to the inverter is less than 10ft, please cut-off the extra length of cables. This will result in reduction in the overall resistance of the cable / reduction in voltage drop and consequently, will improve the efficiency of the inverter system

8.4.6 DC Input Connection

The DC input terminals for battery connection (*8 & 9 in Fig. 6.1*) have cylindrical hole with set screw:

- Hole size: 7/16"
- Set screw:
 - 5/16" x 24 TPI
 - 1/2" long
 - Slotted head



CAUTION!

DO NOT insert the stranded bare end of the wire directly into the tubular hole as the set screw will not pinch all the strands, resulting in a partial / loose contact.



ATTENTION!

NE PAS insérer l'extrémité nue du fil directement dans le trou tubulaire, car la vis de réglage ne pincera pas tous les brins, ce qui provoquerait un contact partiel / lâche.

SECTION 8 | Installation

To ensure firm contact, a pair of pin type terminal lugs have been provided as follows:

- PST-1000-12 : For up to AWG#1/0 (Part No. PTNB50-20)
- PST-1000-24 : For up to AWG#6 (Part No. PTNB16-13)

8.4.7 Reducing RF Interference

Please comply with recommendations given in Section 3.2.

8.5 AC SIDE CONNECTIONS



WARNING! Preventing Paralleling of the AC Output

1. The AC output of the inverter cannot be synchronized with another AC source and hence, it is not suitable for paralleling. The AC output of the inverter should never be connected directly to an electrical breaker panel / load center which is also fed from the utility power/ generator. Such a connection will result in parallel operation and AC power from the utility / generator will be fed back into the inverter which will instantly damage the output section of the inverter and may also pose a fire and safety hazard. If an electrical Breaker Panel / Load Center is being fed from the utility power / generator and the inverter is required to feed this panel as backup power source, the AC power from the utility power/ generator and the inverter should first be fed to a Manual Selector Switch / Automatic Transfer Switch and the output of the Manual Selector Switch / Automatic Transfer Switch should be connected to the Electrical Breaker Panel / Load Center. *Samlex America, Inc. Automatic Transfer Switch, Model No. STS-30 is recommended for this application.*
2. To prevent possibility of paralleling and severe damage to the inverter, never use a simple jumper cable with a male plug on both ends to connect the AC output of the inverter to a handy wall receptacle in the home / RV.



MISE EN GARDE! Empêcher la Sortie CA de Se Mettre en Parallèle

1. La sortie CA de l'appareil ne peut pas être synchronisée avec une autre source CA et ainsi, ce n'est pas approprié de la mettre en parallèle. La sortie CA de l'appareil devrait jamais être directement branchée à un tableau électrique qui est aussi alimenté par la puissance d'un service public / générateur. Une connexion pareille pourrait résulter dans un fonctionnement en parallèle de ces sources de puissance diverses et, la puissance CA produite par le service public / générateur serait alimentée à l'appareil causant des dégâts à la section de sortie, engendrant un risque d'incendie ou de faire mal. Si tableau électrique est alimenté par l'appareil et une puissance provenant des autres sources CA est requise, la puissance CA venant de toutes les sources comme le service public / générateur / l'onduleur devrait être alimentée en premier, à un sélecteur et, la sortie du sélecteur devrait être liée au tableau électrique.
2. Pour empêcher la possibilité que l'onduleur se met en parallèle ou s'endommage sévèrement, n'utilisez pas un câble de raccordement avec un fiche de chaque côté pour brancher la sortie CA de l'onduleur à un réceptacle mural commode dans la maison / VR.

SECTION 8 | Installation

8.5.1 Bonding of AC Output Neutral to Chassis Ground

The Neutral slots of the NEMA5-20R GFCI Duplex Receptacles ([5, Fig 6.1](#)) are internally bonded to the metal chassis of the inverter.

8.5.2 AC Output Connection Through Self Monitoring Ground Fault Circuit Interrupter (GFCI)

An un-intentional electric path between a source of current and a grounded surface is referred to as a "Ground Fault". Ground faults occur when current is leaking somewhere. In effect, electricity is escaping to the ground. How it leaks is very important. If your body provides a path to the ground for this leakage (*dry human body has a low resistance of only around 1 K Ohm*), you could be injured, burned, severely shocked or electrocuted. A Ground Fault Circuit Interrupter (*GFCI*) protects people from electric shock by detecting leakage and cutting off the AC source. The leakage detection circuit compares the current sent to the load and returned back from the load. If the returned current is less by 6 mA due to leakage, Class "A" GFCI will trip. The Class "A" GFCI will also trip if it sees Neutral to Ground bond on the load side of the GFCI.

The AC output of this inverter is available through a NEMA5-20R Self Monitoring GFCI Duplex Receptacle ([5, Fig 6.1](#)). The Neutral slot of this receptacle (*longer rectangular slot*) is internally bonded to the metal chassis of the inverter.

8.5.2.1 Operation of Self Monitoring GFCI: The GFCI used in this unit is Class "A", "Self Monitoring Type" as per UL Standard UL-943. The self monitoring function checks proper operation of the ground fault protection circuitry every 1 to 10 min. If any defect is detected the load side is permanently disconnected with status LED ([5C in Fig 6.1](#)) turning Red. *The GFCI will be required to be replaced.* Details of operation are given below:

- As soon as the inverter is switched on and VAC is made available at the internal line side of the GFCI, status LED ([5C in Fig 6.1](#)) will turn Green, then Red & then steady Green. AC Power will be available at the Load side outlets.
- As soon as the Inverter is switched OFF and 120 VAC is removed from the internal Line Side of the GFCI, the GFCI will be de-energized and there will be no AC output. Status LED ([5C in Fig 6.1](#)) will switch off.
- The Self Monitoring Function inside the GFCI will monitor proper operation of ground fault protection circuitry every 1 to 10 minutes. If defect in the ground fault protection circuit is detected, the LED will turn Red. This indicates permanent fault and *the GFCI will have to be replaced.*

8.5.2.2 Monthly Testing of Self Monitoring GFCI: Test the operation of the GFCI monthly as follows:

- Switch ON the inverter. As explained at Section 8.5.2.1, status LED ([5C in Fig 6.1](#)) will be Green indicating energization of the GFCI.
- Plug a test lamp into the outlet and switch ON the test lamp.
- Press the "Test Button" ([5B in Fig 6.1](#)). The "Reset Button" ([5A in Fig 6.1](#)) will pop out. The GFCI will be forced to trip and cut off AC power to the load side outlets. Status LED ([5C in Fig 6.1](#)) will switch OFF. The test lamp will also switch OFF.

SECTION 8 | Installation

- Press the “Reset Button” (*5A in Fig 6.1*). The GFCI will reset and AC power to the load side outlets will be restored. Status LED (*5C in Fig 6.1*) will turn Green. The test lamp will also switch ON.
- If the above Test / Reset operation cannot be carried out, replace the GFCI.

8.5.2.3 GFCI Tripping and Reset: If there is a leakage of 5 to 6mA due to ground fault on the load side or , there is a Neutral to Ground bond on the load side, the GFCI will trip and the “Reset Button” (*5A in Figs 6.1*) will pop out. AC power to the load side outlets will be cut off. Status LED (*5C in Figs 6.1*) will switch OFF. Remove the ground fault in the load circuit. Press the “Reset Button” (*5A in Fig 6.1*). The GFCI will reset and AC power to the load side outlets will be restored. Status LED (*5C in Figs 6.1*) will turn Green.



INFO

For the Reset Button (*5A, Fig 6.1*) to operate, the Inverter has to be in ON condition so that AC power is available to the internal Line Side of the GFCI.



CAUTION!

1. Do not feed the output from the GFCI receptacle to a Panel Board / Load Center where the Neutral is bonded to the Earth Ground. This will trip the GFCI.
2. If an extension cord is used, please ensure that the cord is 2-Pole Grounding Type (*3 pin*).



ATTENTION!

1. N'alimentent pas la sortie de la prise GFCI à un Panel de sélection / Charger Centre où la position neutre est lié à la terre. Ce qui déclenche le disjoncteur.
2. Si une rallonge est utilisée, veuillez vous assurer que le cordon est mise à la terre à 2 pôles (*3 broches*).

8.6 PROVIDING BACKUP POWER USING TRANSFER SWITCH

For this application, use a Transfer Switch that has Double Pole, Double Throw Contacts like in Samlex America, Inc. Transfer Switch Model No. STS-30. This type of Transfer Switch will be able to switch both the Hot and the Neutral and will prevent tripping of the GFCI due to Neutral to Ground bond in the Utility power (*See Section 8.5.2.3*):

- Feed utility power and output power from the inverter to the two inputs of the Transfer Relay
- Feed the output of the Transfer Switch to a Sub-Panel to feed AC loads requiring backup power
- Do not bond (*connect*) the Neutral and the Ground in the Sub-Panel
- When Utility power is available, the 2 poles of the Transfer Switch will connect the

SECTION 8 | Installation

Hot and Neutral of the Utility power to the Hot and Neutral in the Sub-Panel. The Neutral of the Sub-Panel will be bonded to the Earth Ground through the Main Utility Supply Panel. As the Neutral of the inverter will be isolated from the Neutral of the utility power, the Neutral of the GFCI output will not be bonded to the Earth Ground and the GFCI will not trip

- When the Utility power fails or is interrupted, the Hot and the Neutral of the GFCI will be connected to the Hot and Neutral of the Sub-Panel. As the Neutral is not bonded to Earth Ground in the Sub-Panel, the GFCI in the inverter will not trip. Ground fault protection for the loads connected through the Sub-Panel will be provided by the GFCI on the inverter.

8.7 GROUNDING TO EARTH OR TO OTHER DESIGNATED GROUND

For safety, ground the metal chassis of the inverter to the Earth Ground or to the other designated ground (*For example, in a mobile RV, the metal frame of the RV is normally designated as the Negative DC Ground*). An equipment grounding Lug (*7, Fig 6.1*) has been provided for grounding the metal chassis of the inverter to the appropriate ground.

When using the inverter in a building, connect a 10 mm² or AWG #8 insulated stranded copper wire from the above equipment grounding lug to the Earth Ground connection (*a connection that connects to the Ground Rod or to the water pipe or to another connection that is solidly bonded to the Earth Ground*). The connections must be tight against bare metal. Use star washers to penetrate paint and corrosion.

When using the inverter in a mobile RV, connect a 10 mm² or AWG #8 insulated stranded copper wire from the above equipment grounding lug to the appropriate ground bus of the RV (*usually the vehicle chassis or a dedicated DC Ground Bus*). The connections must be tight against bare metal. Use star washers to penetrate paint and corrosion.

8.8 OPTIONAL WIRED REMOTE CONTROL MODEL RC-15A

An optional Wired Remote Control Model No. RC-15A (*with 16.5 ft. / 5 metre cable*), is available for switching ON and switching OFF. The remote has LED indications similar to the indications on the front panel (*2,3,4 in Fig. 6.1*). Read Remote Control RC-15A Manual for details.

NOTE: For the Remote Control RC-15A to operate, the inverter HAS TO BE POWERED ON FIRST using the On/Off Rocker Switch (1, Fig 6.1).

SECTION 9 | Operation

9.1 SWITCHING THE INVERTER ON/OFF

Before switching on the inverter, check that all the AC loads have been switched off.

2-Position Rocker Switch marked ON/OFF (*1, Fig 6.1*) is used to switch ON / switch OFF the unit locally.

This switch operates a low power control circuitry, which in turn controls all the high power circuitry.

Optional Remote Control Model RC-15A (*Section 8.8*) may also be used to switch ON and switch OFF the inverter.



CAUTION!

Please note that the ON/OFF Switch is not switching the high power battery input circuit. Parts of the DC side circuit will still be alive even when the switch is in the OFF position. Hence, disconnect the DC and AC sides before working on any circuits connected to the inverter.



ATTENTION!

Veillez noter que l'interrupteur ON/OFF ne gère pas le circuit d'entrée de batterie à haute puissance. Certaines parties du circuit de côté CC seraient encore actives même si l'onduleur a été fermé. Alors, il faut déconnecter tous les côtés CC et CA avant de travailler sur n'importe quel circuit connecté à l'onduleur.

When the inverter is switched ON, the GREEN "POWER ON" LED (*2, Fig. 6.1*) will be lighted. This LED indicates that the input section of the inverter is operating normally. Under normal operating conditions, AC output voltage will now be available at the GFCI Duplex Receptacle (*5, Fig 6.1*). The Status LED on the GFCI (*5C in Fig 6.1*) will be lighted Green.

Switch on the AC load(s). The GREEN "POWER ON" LED (*2, Fig 6.1*) and the Green Status LED on the GFCI (*5C in Fig 6.1*) should remain lighted for normal operation of the load.

9.2 POWERING ON THE LOADS

After the inverter is switched on, it takes a finite time to become ready to deliver full power. Hence, always switch on the load(s) after a few seconds of switching on the inverter. Avoid switching on the inverter with the load already switched on. This may prematurely trigger the overload protection.

When a load is switched on, it may require initial higher power surge to start. Hence, if multiple loads are being powered, they should be switched on one by one so that the inverter is not overloaded by the higher starting surge if all the loads are switched on at once.

SECTION 9 | Operation

9.3 TEMPERATURE CONTROLLED COOLING FAN

The cooling fan is thermostatically controlled. The fan sucks air from the ventilation openings at the bottom of the unit (*6A, Fig 6.1*) and discharges through opening at the back of the unit (*6B, Fig 6.1*). Temperature of a critical hot spot inside the inverter is monitored to activate the fan and the over temperature shut-down. When the temperature of this hot spot reaches $55^{\circ}\text{C} \pm 3^{\circ}\text{C}$, the fan is switched ON. The fan will be automatically switched OFF once the hot spot cools down to $45^{\circ}\text{C} \pm 3^{\circ}\text{C}$. Please note that the fan may not come on at low loads or if the ambient temperature is cooler. This is normal.

9.4 INDICATIONS FOR NORMAL OPERATION

When the inverter is operating normally and supplying AC load(s), the GREEN "POWER ON" LED (*2, Fig 6.1*) and the Status LED on the GFCI (*5C in Fig 6.1*) will be lighted Green. Please see under "Protections" (Section 10) and "Troubleshooting Guide" (Section 11) for symptoms of abnormal operation.

9.5 NO LOAD DRAW (IDLE CURRENT)

When the ON/OFF switch is turned on, all the circuitry inside the inverter becomes alive and the AC output is made available. In this condition, even when no load is being supplied (or, if a load is connected but has been switched OFF), the inverter draws a small amount of current from the batteries to keep the circuitry alive and ready to deliver the required power on demand ($<800\text{mA}$ for *PST-1000-12* and $<600\text{mA}$ for *PST-1000-24*). This is called the "idle current" or the "no load draw". Hence, when the load is not required to be operated, turn OFF the ON/OFF switch on the inverter to prevent unnecessary current drain from the battery.



INFO

When the inverter is turned OFF using the optional Remote Control RC-15A, some control circuitry in the inverter is still alive and will draw very low current. Therefore, to prevent any drain from the battery, switch OFF the inverter from the ON/OFF switch provided on the front panel of the inverter.



INFO

Si l'onduleur est fermé avec la Télécommande RC-15, quelques circuits resteront actifs et continueront à tirer un faible courant. Afin de prévenir une perte de tension de la batterie, fermez l'onduleur en utilisant l'interrupteur ON/OFF situé sur le devant de l'onduleur.

SECTION 10 | Protections

10. PROTECTIONS

The inverter has been provided with protections detailed below:

10.1 POWER SURGE / OVERLOAD / SHORT CIRCUIT PROTECTIONS



INFO

Please refer to definitions of Active Power (Watts, W), Apparent Power (VA) and Power Factor (PF) at Section 2.1. In the explanation below, the values of Power are expressed in Apparent Power (VA). Corresponding Active Power (Watts, W) will depend upon the type of load (Resistive or Reactive) and its Power Factor, (PF) (The value of PF may range from 1 to 0.5). Please note the following:

- Active Power (Watts, W) = Apparent Power (VA) x Power Factor (PF).
- For resistive type of loads, the Power Factor (PF) = 1 and hence, Apparent Power (VA) = Active Power (Watts, W)
- For reactive types of loads, the Power Factor (PF) will be < 1 (up to 0.5) and hence, the Active Power (Watts, W) will be less than the Apparent Power (VA)



INFO

Veillez vous reporter aux définitions de la puissance active (Watts, W), la puissance apparente (VA) et le facteur de puissance (PF) à la section 2.1. Dans l'explication ci-dessous, les valeurs de puissance sont exprimées dans la puissance apparente (VA). Puissance active correspondante (Watts, W) dépendra du type de charge (charge résistive ou réactif) et c'est le facteur de puissance (facteur de puissance peut aller de 1 à 0,5). Veuillez noter ce qui suit :

- Puissance active (W) = Puissance apparente (VA) x Facteur de puissance (PF).
- Pour les charges de type résistif, le facteur de puissance = 1 et par conséquent, la puissance apparente (VA) = Puissance active (Watts, W)
- Pour les types de charges, le facteur de puissance sera < 1 (jusqu'à 0,5) et par conséquent, la puissance active (Watts, W) est inférieure à la puissance apparente (VA)

10.1.1 Surge Power Rating: "Surge Power Rating" of an inverter indicates its short term overload capability i.e. its capability to provide higher than its rated continuous power for a very short duration to enable starting of certain types of devices/ appliances like electric motor driven pumps, compressors etc. that require higher starting power than their rated continuous running power. More examples of such types of devices/ appliances are given at Section 2.5, Table 2.1.

Surge Power ratings of PST-1000-12/ PST-1000-24 is 2000W (200% of its rated continuous power of 1000W) for < 1 sec.

If the AC load continues to draw power equal to the above surge power/ short-term overload limits, the inverter will shut down due to overload / short circuit protection described at Sections 10.1.2 and 10.1.3 below.

SECTION 10 | Protections

10.1.2 Overload: If there is a continuous overload of 110% to 115% for 2 to 3 sec, the output voltage will be shut down. Red LED marked "OVERLOAD" (3, Fig 6.1) will turn ON, the Status LED on the GFCI outlet (5C, Fig 6.1) will be OFF and buzzer alarm will sound. The Green LED marked "POWER ON" (2, Fig 6.1) will continue to be lighted. The unit will be latched in this shut down condition and will require manual reset. To reset, switch OFF the unit using the ON/OFF Switch (1, Fig 6.1), wait for 3 minutes and then switch ON the unit again. Before switching ON, determine and remove the cause of overloading.

10.1.3 Short Circuit: Short circuit condition will be detected when the AC output voltage drops to 80VAC or lower over a period of up to 5 sec. The AC output voltage will be shut down thereafter. Red LED marked "OVERLOAD" (3, Fig 6.1) will turn ON, the Status LED on the GFCI outlet (5C, Fig 6.1) will be OFF and buzzer alarm will sound. The Green LED marked "POWER ON" (2, Fig 6.1) will continue to be lighted. The unit will be latched in this shut down condition and will require manual reset. To reset, switch OFF the unit using the ON/OFF Switch (1, Fig 6.1), wait for 3 minutes and then switch ON the unit again. Before switching ON, determine and remove the cause of short circuit.

10.2 WARNING ALARM - LOW DC INPUT VOLTAGE

The voltage at the DC input terminals will be lower than the voltage at the battery terminals due to voltage drop in the battery cables and connectors. The drop in the voltage at the DC input terminals of the inverter could be due to lower battery terminal voltage or due to abnormally high drop in the battery cables if the cables are not thick enough (Please see Section 8.4.3). If the voltage at the DC input terminals drops to $10.7V \pm 0.1V$ for PST-1000-12 or to $21.4V \pm 0.2V$ for PST-1000-24, a buzzer alarm will be sounded. The GREEN "POWER ON" LED (2, Fig 6.1) and the Status LED on the GFCI (5C, Fig 6.1) will continue to be GREEN and the AC output voltage would continue to be available. This warning buzzer alarm indicates that the battery is running low and that the inverter will be shut down after sometime if the voltage at the inverter terminals further drops to $10V \pm 0.1V$.

10.3 LOW DC INPUT VOLTAGE SHUT DOWN

If the voltage at the DC input terminals drops to $10V \pm 0.1V$ for PST-1000-12 or to $20V \pm 0.2V$ for PST-1000-24, the AC output is shut down. Buzzer alarm is sounded. The GREEN "POWER ON" LED (2, Fig 6.1) will remain lighted. The Status LED on the GFCI (5C, Fig 6.1) will be OFF.

The unit will reset automatically when the DC input voltage rises to $11.5V \pm 0.3V$ for PST-1000-12 or to $23.0V \pm 0.5V$ for PST-1000-24.

10.4 HIGH DC INPUT VOLTAGE SHUTDOWN

If the voltage at the DC input terminals rises to 16.5V for PST-1000-12 or 33.0V for PST-1000-24, the inverter will be shut down temporarily. Buzzer alarm will be sounded. The GREEN "POWER ON" LED (2, Fig 6.1) will remain lighted. The Status LED on the GFCI (5C, Fig 6.1) will be OFF. The unit will be reset automatically when the voltage drops down to $< 16.5V$ for PST-1000-12 or $< 33.0V$ for PST-1000-24.

SECTION 10 | Protections

10.5 OVER-TEMPERATURE SHUT DOWN

In case of failure of the cooling fan or in the case of inadequate heat removal due to higher ambient temperatures / insufficient air exchange, the temperature inside the unit will increase. The temperature of a critical hot spot inside the inverter is monitored and at $90^{\circ} \pm 5^{\circ}\text{C}$, the AC output of the inverter is shut down temporarily. Buzzer alarm will be sounded. The GREEN "POWER ON" LED (2, Fig 6.1) will remain lighted. The Status LED on the GFCI (5C, Fig 6.1) will be OFF.

The unit will automatically reset after the hot spot has cooled down to $65^{\circ} \pm 5^{\circ}\text{C}$.

10.6 GROUND FAULT/ LEAKAGE PROTECTION

AC Output is supplied through NEMA5-20R Self Monitoring GFCI Duplex Receptacle (5, Fig 6.1). The GFCI will trip if there is 6 mA leakage/ Ground fault on the load side or, if Neutral and Ground are bonded on the load side. When tripped, the Status LED (5C, Fig 6.1) will be switched OFF. Remove the cause of tripping. Switch ON the inverter if OFF and then, press the "Reset Button" (5A, Fig 6.1) on the GFCI to reset (*GFCI will not reset if the inverter is OFF and there is no AC voltage on the internal Line Side of the GFCI*). (Refer to Section 8.5.2 for detailed information on the GFCI and its operation)

10.7 REVERSE POLARITY AT THE DC INPUT TERMINALS

The Positive of the battery should be connected to the Positive DC input terminal of the inverter (9, Fig 6.1) and the Negative of the battery should be connected to the Negative DC input terminal of the inverter (8, Fig 6.1). A reversal of polarity (*the Positive of the battery wrongly connected to the Negative DC input terminal of the inverter and the Negative of the battery wrongly connected to the Positive DC input terminal of the inverter*) will blow the external / internal DC side fuses. If the DC side fuse is blown, the inverter will be dead. Green LED marked "POWER ON" (2, Fig 6.1) and the Status LED on the GFCI (5C, Fig 6.1) will be switched OFF and there will be no AC output.



INFO

Reverse polarity connection is likely to damage the DC input circuitry. The internal fuse(s) should be replaced with the correct size of fuse shown under specifications. If the unit does not work after replacing the fuse(s), it has been permanently damaged and will require repair / replacement (*Please read Section 11 - "Troubleshooting Guide" for more details*).



INFO

Un inversement des polarités va probablement endommager les circuits d'entrée CC. Il faut remplacer le(s) fusible(s) avec un/des fusible(s) d'une taille pareille. Si après l'installation, l'appareil ne marche pas, c'est qu'il soit endommagé en permanence et aura besoin d'une réparation ou un remplacement (*Pour des renseignements supplémentaires, veuillez regarder à la Section 11 - «Guide de Dépannage»*).

SECTION 10 | Protections



CAUTION!

Damage caused by reverse polarity is not covered by warranty! When making battery connections on the input side, make sure that the polarity of battery connections is correct (Connect the Positive of the battery to the Positive terminal of the unit (9, Fig 6.1) and the Negative of the battery to the Negative terminal of the unit (8, Fig 6.1)). If the input is connected in reverse polarity, DC fuse(s) inside the inverter / external fuse will blow and may also cause permanent damage to the inverter.



ATTENTION!

Des dégâts causés par un inversement de polarités ne sont pas couverts par la garantie! Quand vous faites des connexions à la batterie du côté d'entrée, veuillez assurer que les polarités sont mises du bon côté (Lié le Positif de la batterie à la borne Positive de l'appareil et le Négatif de la batterie à la borne Négative de l'appareil). Si les polarités de l'entrée sont mises à l'envers, le fusible CC externe du côté d'entrée va s'exploser et pourrait causer des dégâts permanents à l'onduleur.

10.8 INTERNAL DC SIDE FUSES

The following internal fuses have been provided to protect against ground fault/ overload/ reverse polarity on the DC side. The fuses are 32V, Automotive Type Blade Fuses, Type "ATO" by Littell Fuse or equivalent:

- **PST-1000-12:** 4 pieces of 40A fuses in parallel = 160A total; 32V
- **PST-1000-24:** 4 pieces of 20A fuses in parallel = 80A total; 32V

NOTE: The fuses are installed in Fuse Holders. Hence, these can be removed and replaced easily.

SECTION 11 | Troubleshooting Guide

SYMPTOMS	POSSIBLE CAUSE	REMEDY
<p>When switched ON:</p> <ul style="list-style-type: none"> Green LED marked "POWER" (2, Fig 6.1) does not light Buzzer is OFF There is no AC output Status LED on the GFCI (5C, Fig 2.1) is OFF 	<p>There is no voltage at the DC input terminals</p>	<ul style="list-style-type: none"> Check the continuity of the battery input circuit. Check that the internal/external DC input fuses are intact. Replace if blown. Check that all connections in the battery input circuit are tight.
	<p>Polarity of the DC input voltage has been reversed that has blown the external / internal DC side fuses (Note: Reverse polarity may cause permanent damage. Damage caused due to reverse polarity is not covered by warranty)</p>	<ul style="list-style-type: none"> Check external and internal fuses. Replace fuses. If unit does not work, call Technical Support for repair.
<ul style="list-style-type: none"> Low AC output voltage (< 120VAC but > 80VAC) No buzzer alarm 	<ul style="list-style-type: none"> AC load is exceeding Surge Overload of 2000W Load is approaching Surge Overload of 2000W during lower DC input voltage 	<ul style="list-style-type: none"> Check that the battery is fully charged. Recharge, if low. Check that the battery cables are thick enough to carry the required current over the required length. Use thicker cables, if required. Tighten connections of battery input circuit. Reduce load.
<ul style="list-style-type: none"> AC output voltage is available Buzzer alarm is sounded at no load or, when load is switched on The Green LED marked "POWER ON" (2, Fig 6.1) is lighted Status LED on the GFCI outlet (5C, Fig 6.1) is lighted Green 	<ul style="list-style-type: none"> Low DC input voltage alarm PST-1000-12: DC input voltage is $10.7 \pm 0.1V$ or lower but higher than $10V \pm 0.1V$ PST-1000-24: DC input voltage is $21.4 \pm 0.2V$ or lower but higher than $20V \pm 0.2V$ 	<ul style="list-style-type: none"> Check that the battery is fully charged. Recharge, if low. Check that the battery cables are thick enough to carry the required current over the required length. Use thicker cables, if required. Tighten connections of the battery input circuit.
<ul style="list-style-type: none"> There is no AC output voltage Buzzer alarm is sounded at no load or when load is switched on Green LED marked "POWER ON" (2, Fig 6.1) is lighted Status LED on the GFCI outlet (5C, Fig 6.1) is OFF 	<ul style="list-style-type: none"> AC output voltage has been shut down due to low DC input voltage PST-1000-12: DC input voltage is $10 \pm 0.1V$ or lower PST-1000-24: DC input voltage is $20 \pm 0.2V$ or lower 	<ul style="list-style-type: none"> Check that the battery is fully charged. Recharge, if low. Check that the battery cables are thick enough to carry the required current over the required length. Use thicker cables, if required. Tighten connections of the battery input circuit. The AC output voltage will switch ON automatically when the DC input voltage rises to $11.5V \pm 0.3V$ or higher for PST-1000-12 or, $23V \pm 0.5V$ or higher for PST-1000-24
<p>...Continued on page 56</p>		

SECTION 11 | Troubleshooting Guide

SYMPTOMS	POSSIBLE CAUSE	REMEDY
<ul style="list-style-type: none"> There is no AC output The Green LED marked "POWER" (2, Fig 6.1) is lighted Buzzer is on. Status LED on the GFCI outlet (5C, Fig 6.1) is OFF 	<p>Shut-down due to high input DC voltage</p> <ul style="list-style-type: none"> DC input voltage is 16.5V or higher for PST-1000-12 DC input voltage is 33V or higher for PST-1000-24 	<p>Refer to precautions detailed at Section 8.4.1 to prevent DC input over voltage</p> <ul style="list-style-type: none"> The unit will reset automatically when the DC input voltage drops below 16.5V for PST-1000-12 or below 33V for PST-1000-24
<ul style="list-style-type: none"> AC output shuts down completely Red LED marked "OVERLOAD" (3, Fig 6.1) is lighted Buzzer alarm is ON Green LED marked "POWER ON" (2, Fig 6.1) is lighted Status LED on the GFCI outlet (5C, Fig 6.1) is OFF 	<p>Permanent shut-down of the AC output due to:</p> <ul style="list-style-type: none"> Continuous overload more than 110% - 115% OR Short circuit on the AC load side 	<ul style="list-style-type: none"> Reduce the load / remove the short circuit The load is not suitable as it requires higher power to operate. Use an inverter with higher power rating. If the unit goes into permanent overload again after resetting and removing the load completely, the unit has become defective. Call Technical support. <p>NOTE: The unit will be latched in this shut-down condition and will require manual reset. To reset, switch OFF the power ON/OFF switch (1, Fig 6.1), wait for 3 minutes and then switch ON again. Before switching ON again, remove the cause of the shut-down.</p>
<ul style="list-style-type: none"> There is no AC output. Buzzer alarm is sounded. The Green LED marked "POWER" (2, Fig 6.1) is lighted. Green indication light on the GFCI is OFF. Buzzer alarm is ON Red LED marked "OVER TEMP" (4, Fig 6.1) is lighted Green LED marked "POWER ON" is lighted Status LED on the GFCI outlet (5C, Fig 6.1) is OFF 	<p>Shut-down due to over temperature because of fan failure or inadequate cooling as a result of high ambient temperature or insufficient air exchange</p> <ul style="list-style-type: none"> Internal hot spot is at $90 \pm 5^\circ\text{C}$ or higher 	<p>Check that the fan is working. If not, the fan control circuit may be defective. Call Technical Support.</p> <p>If the fan is working, check that the ventilation slots on the suction side and the openings on the discharge side of the fan are not obstructed.</p> <p>If the fan is working and the openings are not obstructed, check that enough cool replacement air is available. Also check that the ambient air temperature is less than 40°C.</p> <p>Reduce the load to reduce the heating effect. After the cause of overheating is removed and the internal hot spot cools down to $65 \pm 5^\circ\text{C}$, the AC output will be restored automatically.</p>
<ul style="list-style-type: none"> There is no AC output from the GFCI outlet (5, Fig 6.1) Green LED marked "POWER ON" (2, Fig 6.1) is lighted No buzzer alarm Status LED on the GFCI outlet (5C, Fig 6.1) is OFF Reset Button on the GFCI outlet (5A, Fig 6.1) has popped out 	<p>GFCI has tripped due to leakage or due to Neutral to Ground bond on the load side.</p>	<p>Check load side circuits for leakage or Neutral to Ground bond and remove this ground fault condition. Switch ON the inverter if in OFF condition. Check that the Green LED marked "POWER ON" (2, Fig 6.1) is lighted. Press Reset Button (5A, Fig 6.1) on the GFCI to reset the GFCI. On resetting, the Status LED on the GFCI (5C, Fig 6.1) will be lighted Green.</p>
<ul style="list-style-type: none"> There is no AC output from the GFCI outlet (5, Fig 6.1) Green LED marked "POWER ON" (2, Fig 6.1) is lighted No buzzer alarm Status LED on the GFCI outlet (5C, Fig 6.1) is lighted Red 	<p>Self monitoring circuit of GFCI is defective.</p>	<p>Call Technical Support. GFCI will be required to be replaced.</p>

SECTION 12 | Specifications

MODEL NO.	PST-1000-12	PST-1000-24
OUTPUT		
OUTPUT VOLTAGE	120 VAC ± 3%	120 VAC ± 3%
MAXIMUM OUTPUT CURRENT	8.5A	8.5A
OUTPUT FREQUENCY	60 Hz ± 1%	60 Hz ± 1%
TYPE OF OUTPUT WAVEFORM	Pure Sine Wave	Pure Sine Wave
TOTAL HARMONIC DISTORTION OF OUTPUT WAVEFORM	< 3%	< 3%
CONTINUOUS OUTPUT POWER (At Power Factor = 1)	1000 Watts	1000 Watts
SURGE OUTPUT POWER	2000 Watts	2000 Watts
PEAK EFFICIENCY	> 85%	> 85%
AC OUTPUT CONNECTIONS	NEMA5-20R GFCI Duplex Outlets.	NEMA5-20R GFCI Duplex Outlets.
INPUT		
NOMINAL DC INPUT VOLTAGE	12V	24V
DC INPUT VOLTAGE RANGE	10.7 - 16.5 VDC	21.4 - 33 VDC
MAXIMUM DC INPUT CURRENT	160A	80A
DC INPUT CURRENT AT NO LOAD	< 800 mA	< 600 mA
DC INPUT CONNECTIONS	Tubular hole diameter: 7/16"; Set Screw 5/16" x 24TPI 1/2" long, slotted	
DC INPUT FUSES (INTERNAL)	4 x 40A = 160A (Each 40A, 32V, Automotive, Blade Type)	4 x 20A = 80A (Each 20A, 32V, Automotive, Blade Type)
DISPLAY		
LED	Power, Overload, Over Temperature	Power, Overload, Over Temperature
PROTECTIONS		
LOW DC INPUT VOLTAGE ALARM	10.7V ± 0.1V	21.4V ± 0.2V
LOW DC INPUT VOLTAGE SHUTDOWN	10V ± 0.1V; Auto-reset: 11.5V ± 0.3V	20V ± 0.2V; Auto-reset: 23V ± 0.5V
HIGH DC INPUT VOLTAGE SHUTDOWN	16.5V; Auto-reset: < 16.5V	33V; Auto-reset: < 33V
SHORT CIRCUIT SHUTDOWN	When output voltage drops to 80V or lower	
OVERLOAD SHUTDOWN	At overload of 110% to 115%	
GROUND FAULT SHUTDOWN	Through GFCI outlets (6 mA leakage)	
OVER TEMPERATURE SHUTDOWN	90°C ± 5°C; Auto reset at 65°C ± 5°C	
REVERSE POLARITY ON DC INPUT SIDE	External / internal DC sides fuses will blow	
REMOTE CONTROL		
WIRED REMOTE CONTROL	• Remote Control Model RC-15A with LED display & 5 m / 16.5 ft cable connected through Modular Jack Connector (6P6C) (optional)	
COOLING		
FORCED AIR COOLING	Temperature controlled fan Fan ON at 55°C ± 3°C; Fan OFF at 45°C ± 3°C	
COMPLIANCE		
SAFETY	Intertek - ETL Listed. Conforms to ANSI/UL Standard 458 and certified to CSA Standard C22.2 No. 107.1-01	
EMI / EMC	FCC Part 15(B), Class B	
HAZARDOUS SUBSTANCE RESTRICTION	Lead Free 	
ENVIRONMENT		
WORKING ENVIRONMENT	Indoor use	
OPERATING TEMPERATURE RANGE	-20 to 40°C / -4 to 104°F	
STORAGE TEMPERATURE	-30 to 70°C / -22 to 158°F	
RELATIVE HUMIDITY	90%, non condensing	
DIMENSIONS		
(W X D X H), MM	238 x 397 x 82	238 x 397 x 82
(W X D X H), INCHES	9.37 x 15.63 x 3.23	9.37 x 15.63 x 3.23
WEIGHT		
KG	4.0	4.0
LBS	8.8	8.8

NOTES:

1. All power ratings are specified for resistive load at Power Factor = 1.
2. All specifications given above are at ambient temperature of 25°C / 77°F.
3. Specifications are subject to change without notice

SECTION 12 | Specifications



CAUTION! RISK OF FIRE

Do not replace any vehicle fuse with a rating higher than recommended by the vehicle manufacturer. PST-1000-12 is rated to draw 160A from 12V vehicle circuit and PST-1000-24 is rated to draw 80A from 24V vehicle circuit. Ensure that the electrical system in your vehicle can supply this product without causing the vehicle fusing to open. This can be determined by making sure that the fuse in the vehicle, which protects the circuit, is rated higher than 160A for PST-1000-12 or higher than 80A for PST-1000-24. Information on the vehicle fuse ratings is typically found in the vehicle operator's manual. If a vehicle fuse opens repeatedly, do not keep on replacing it. The cause of the overload must be found. On no account should fuses be patched up with tin foil or wire as this may cause serious damage elsewhere in the electrical circuit or cause fire.



ATTENTION! RISQUE D'INCENDIE!

Ne remplacez pas un fusible de véhicule avec une taille plus grande que celle qui est re-comandée par le fabricant du véhicule. Le PST-1000-12 est conçu pour tirer 160A du circuit de véhicule 12V et PST-1000-24 pour 80A du circuit de véhicule 24V. Alors, il faut assurer que le système électrique dans le véhicule puisse alimenter l'onduleur sans que le fusible s'ouvre. Vérifiez, en lisant le manuel du véhicule, que le fusible qui protège la prise (du véhicule) est fabriqué pour plus que 160A pour PST-1000-12 ou supérieur à 80A pour PST-1000-24. Si le fusible s'ouvre plusieurs fois, ne continuez pas de le remplacer. Dans ce cas, il faut trouver la cause de la surcharge. Il faut jamais essayer de réparer/com-bler un fusible avec un fil ou papier aluminium, ça pourrait engendrer des dégâts dans le circuit électrique ou même causer un incendie.

SECTION 13 | Warranty

3 YEAR LIMITED WARRANTY

PST-1000-12/ PST-1000-24 manufactured by Samlex America Inc. (the "Warrantor") are warranted to be free from defects in workmanship and materials under normal use and service. The warranty period is 3 years for the United States and Canada, and is in effect from the date of purchase by the user (the "Purchaser").

Warranty outside of the United States and Canada is limited to 6 months. For a warranty claim, the Purchaser should contact the place of purchase to obtain a Return Authorization Number.

The defective part or unit should be returned at the Purchaser's expense to the authorized location. A written statement describing the nature of the defect, the date of purchase, the place of purchase, and the Purchaser's name, address and telephone number should also be included.

If upon the Warrantor's examination, the defect proves to be the result of defective material or workmanship, the equipment will be repaired or replaced at the Warrantor's option without charge, and returned to the Purchaser at the Warrantor's expense. (Contiguous US and Canada only)

No refund of the purchase price will be granted to the Purchaser, unless the Warrantor is unable to remedy the defect after having a reasonable number of opportunities to do so. Warranty service shall be performed only by the Warrantor. Any attempt to remedy the defect by anyone other than the Warrantor shall render this warranty void. There shall be no warranty for defects or damages caused by faulty installation or hook-up, abuse or misuse of the equipment including exposure to excessive heat, salt or fresh water spray, or water immersion.

No other express warranty is hereby given and there are no warranties which extend beyond those described herein. This warranty is expressly in lieu of any other expressed or implied warranties, including any implied warranty of merchantability, fitness for the ordinary purposes for which such goods are used, or fitness for a particular purpose, or any other obligations on the part of the Warrantor or its employees and representatives.

There shall be no responsibility or liability whatsoever on the part of the Warrantor or its employees and representatives for injury to any persons, or damage to person or persons, or damage to property, or loss of income or profit, or any other consequential or resulting damage which may be claimed to have been incurred through the use or sale of the equipment, including any possible failure of malfunction of the equipment, or part thereof. The Warrantor assumes no liability for incidental or consequential damages of any kind.

Samlex America Inc. (the "Warrantor")

www.samlexamerica.com

Contact Information

Toll Free Numbers

Ph: 1 800 561 5885

Fax: 1 888 814 5210

Local Numbers

Ph: 604 525 3836

Fax: 604 525 5221

Website

www.samlexamerica.com

USA Shipping Warehouses

Kent, WA

Plymouth, MI

Canadian Shipping Warehouse

Delta, BC

Email purchase orders to

orders@samlexamerica.com



samlexamerica®