



HiSecEngine USG6000F Series

Quick Start

Issue 04

Date 2023-01-18

Copyright © Huawei Technologies Co., Ltd. 2023. All rights reserved.

No part of this document may be reproduced or transmitted in any form or by any means without prior written consent of Huawei Technologies Co., Ltd.

Trademarks and Permissions



HUAWEI and other Huawei trademarks are trademarks of Huawei Technologies Co., Ltd.

All other trademarks and trade names mentioned in this document are the property of their respective holders.

Notice

The purchased products, services and features are stipulated by the contract made between Huawei and the customer. All or part of the products, services and features described in this document may not be within the purchase scope or the usage scope. Unless otherwise specified in the contract, all statements, information, and recommendations in this document are provided "AS IS" without warranties, guarantees or representations of any kind, either express or implied.

The information in this document is subject to change without notice. Every effort has been made in the preparation of this document to ensure accuracy of the contents, but all statements, information, and recommendations in this document do not constitute a warranty of any kind, express or implied.

Huawei Technologies Co., Ltd.

Address: Huawei Industrial Base
Bantian, Longgang
Shenzhen 518129
People's Republic of China

Website: <https://e.huawei.com>

Contents

1 About This Document.....	1
2 Device Introduction and Cable Connection.....	4
2.1 USG6510F-D, USG6530F-D.....	4
2.2 USG6510F-DL, USG6530F-DL.....	6
2.3 USG6525F, USG6555F, USG6565F, USG6585F.....	8
2.4 USG6525F, USG6555F, USG6565F, USG6585F, USG6615F, USG6625F.....	10
2.5 USG6635F, USG6655F, USG6685F.....	12
2.6 USG6710F, USG6715F.....	13
2.7 USG6725F.....	16
3 Accessing the Internet.....	18
4 Appendix.....	30
4.1 Supplier's Declaration of Conformity (SDoC).....	30
4.2 Obtaining Product Documents and Technical Support.....	30

1 About This Document

Overview

Thank you for using USG6000F series products. This document shows the product appearance and provides the essential information required for cable connections and initial configuration of the USG6000F, helping you quickly complete the initial installation and configuration of the USG6000F. For detailed hardware description, refer to the *Hardware Guide*. For detailed configurations, refer to the *Configuration Guide*.

The following table lists the product version related to this document.





Product Name	Version
• USG6510F-D	V600R020C10
• USG6510F-DL	V600R021C00
• USG6525F	V600R021C10
• USG6530F-D	V600R022C00
• USG6530F-DL	V600R022C10
• USG6555F	
• USG6565F	
• USG6585F	
• USG6615F	
• USG6625F	
• USG6635F	
• USG6655F	
• USG6685F	
• USG6710F	
• USG6715F	
• USG6725F	

Intended Audience

This document is intended for installation personnel and administrators who install and maintain USG6000F. The installation personnel or administrators must have experience in the installation and maintenance of networking devices.

Symbol Conventions

The symbols that may be found in this document are defined as follows.

Symbol	Description
 DANGER	Indicates a hazard with a high level of risk which, if not avoided, will result in death or serious injury.
 WARNING	Indicates a hazard with a medium level of risk which, if not avoided, could result in death or serious injury.
 CAUTION	Indicates a hazard with a low level of risk which, if not avoided, could result in minor or moderate injury.
 NOTICE	Indicates a potentially hazardous situation which, if not avoided, could result in equipment damage, data loss, performance deterioration, or unanticipated results. NOTICE is used to address practices not related to personal injury.
 NOTE	Supplements the important information in the main text. NOTE is used to address information not related to personal injury, equipment damage, and environment deterioration.

Update History

Updates between document issues are cumulative. Therefore, the latest document issue contains all updates made in previous issues.

Issue 05 (2023-04-21)

The fifth commercial release.

- Added the [USG6525F](#), [USG6555F](#), [USG6565F](#), [USG6585F](#), [USG6510F-D](#), [USG6530F-D](#), [USG6510F-DL](#), [USG6530F-DL](#).

Issue 04 (2022-11-24)

The fourth commercial release.

Issue 03 (2022-05-12)

The third commercial release.

- Added the **USG6685F**.
- Added the **USG6710F, USG6715F**.
- Added the **USG6725F**.

Issue 02 (2021-08-20)

The second commercial release.

Issue 01 (2021-01-29)

Initial commercial release.

2 Device Introduction and Cable Connection

 **DANGER**

- Deactivate power whenever possible before performing maintenance on power cables.
 - Always wear a properly-grounded wrist strap before touching the device.
 - Laser beams will cause eye damage. Do not look into bores of optical modules or optical fibers without eye protection.
-

 **NOTE**

- Figures in the document are for reference only and may be different from actual devices.
- The type and quantity of items in a packing list vary with the product model. Check the delivered items against the actual packing list.
- Some devices are delivered with dust plugs. Cover idle optical interfaces with dust plugs. Keep the unused dust plugs for future use.
- The power cable varies according to the delivery country.
- To use adjustable mounting ears at the rear or adjustable guide rails, purchase them separately.

2.1 USG6510F-D, USG6530F-D

Device and Auxiliary Materials

Figure 2-1 Appearance and auxiliary materials of the USG6510F-D, USG6530F-D

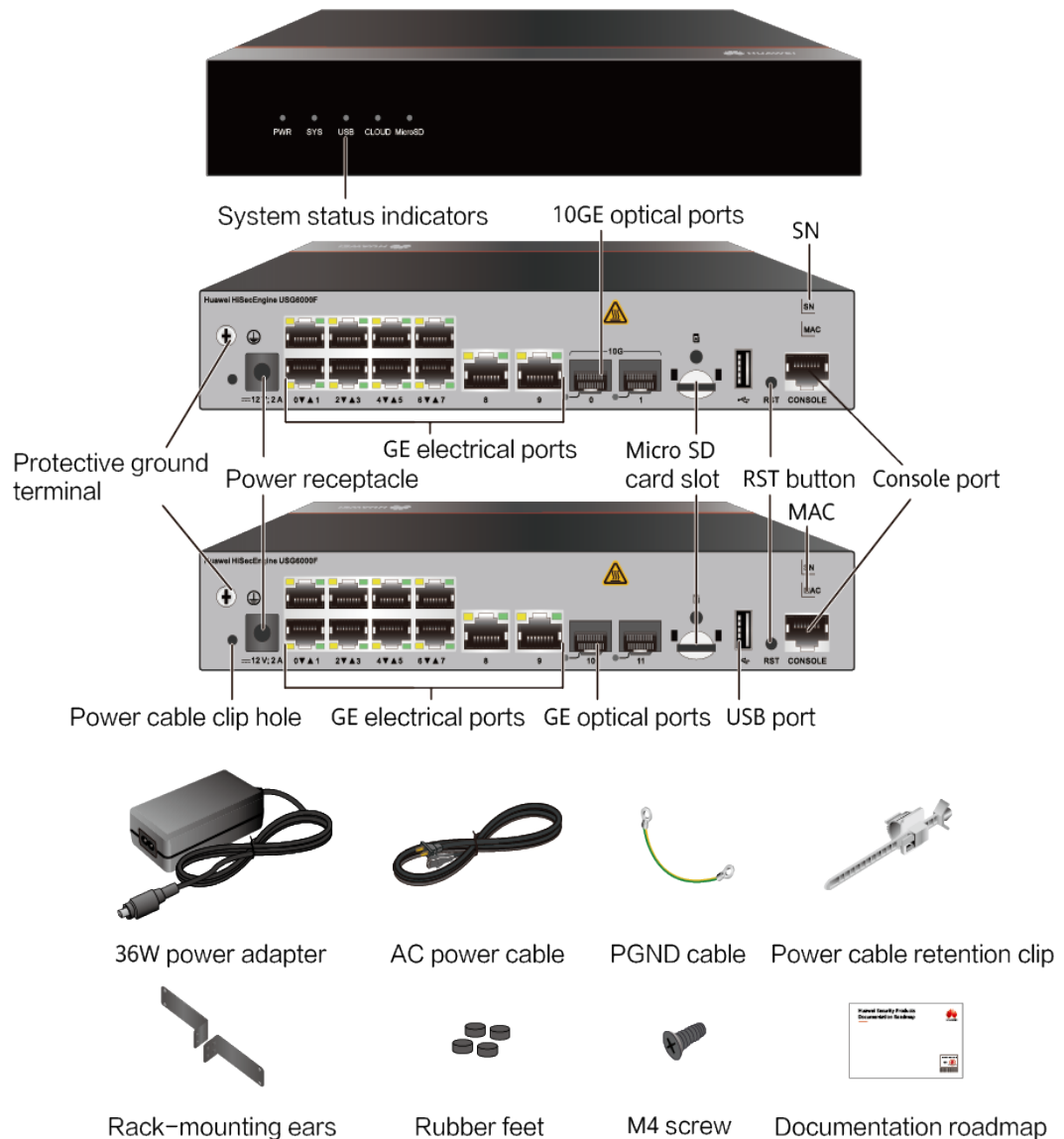

In the preceding figure, the USG6530F-D rear panel is on the center and the USG6510F-D rear panel is on the lower.

NOTE

- The mounting ears are optional.
- The power cable varies according to the delivery country.

Cable Connection

Connect cables according to [Figure 2](#) and power on the device. As device does not provide a power switch, it starts up immediately after receiving power. When the SYS indicator on the front panel is blinking (once every two seconds), the device is running and ready for configuration.

Figure 2-2 Connecting cables of USG6510F-D, USG6530F-D

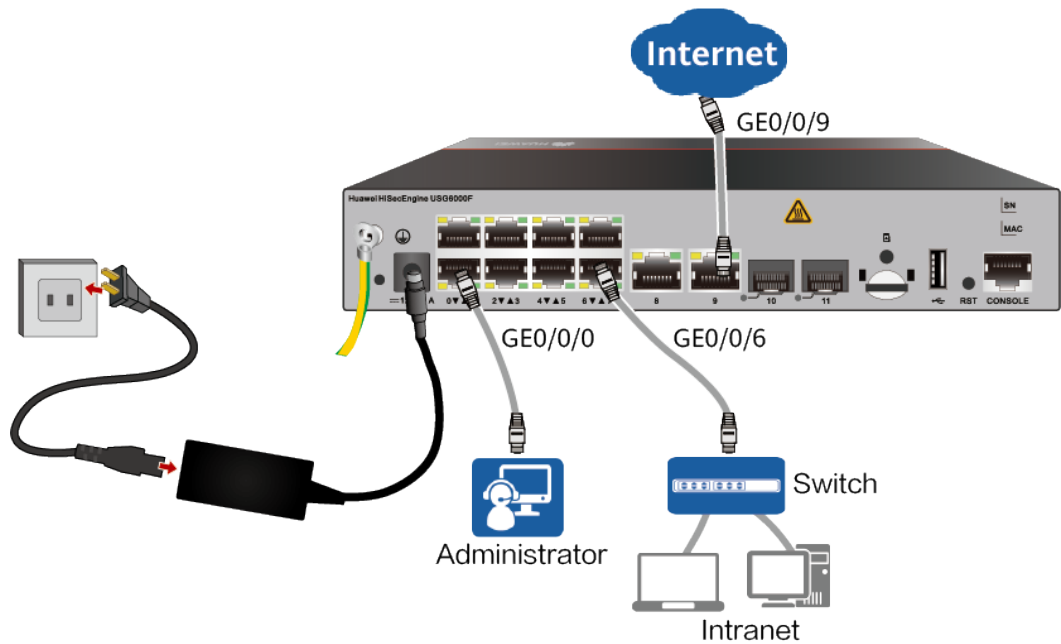

NOTE

After the power cable is installed, adjust the cable-retention clip to an appropriate position, use a cable-retention clip to bundle the cable of the power adapter, and adjust the cable-retention clip to fasten the cable.

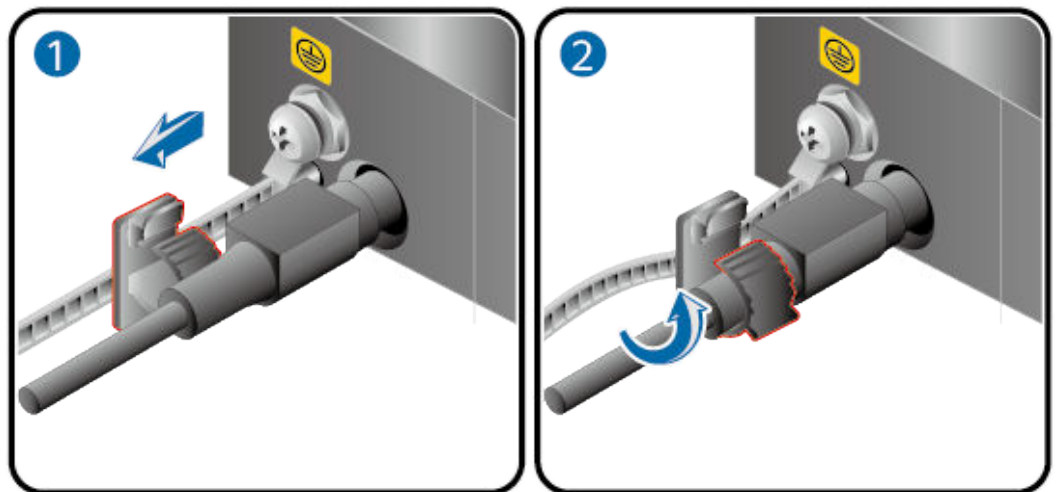

2.2 USG6510F-DL, USG6530F-DL

Device and Auxiliary Materials

Figure 2-3 Appearance and auxiliary materials of the USG6510F-DL, USG6530F-DL

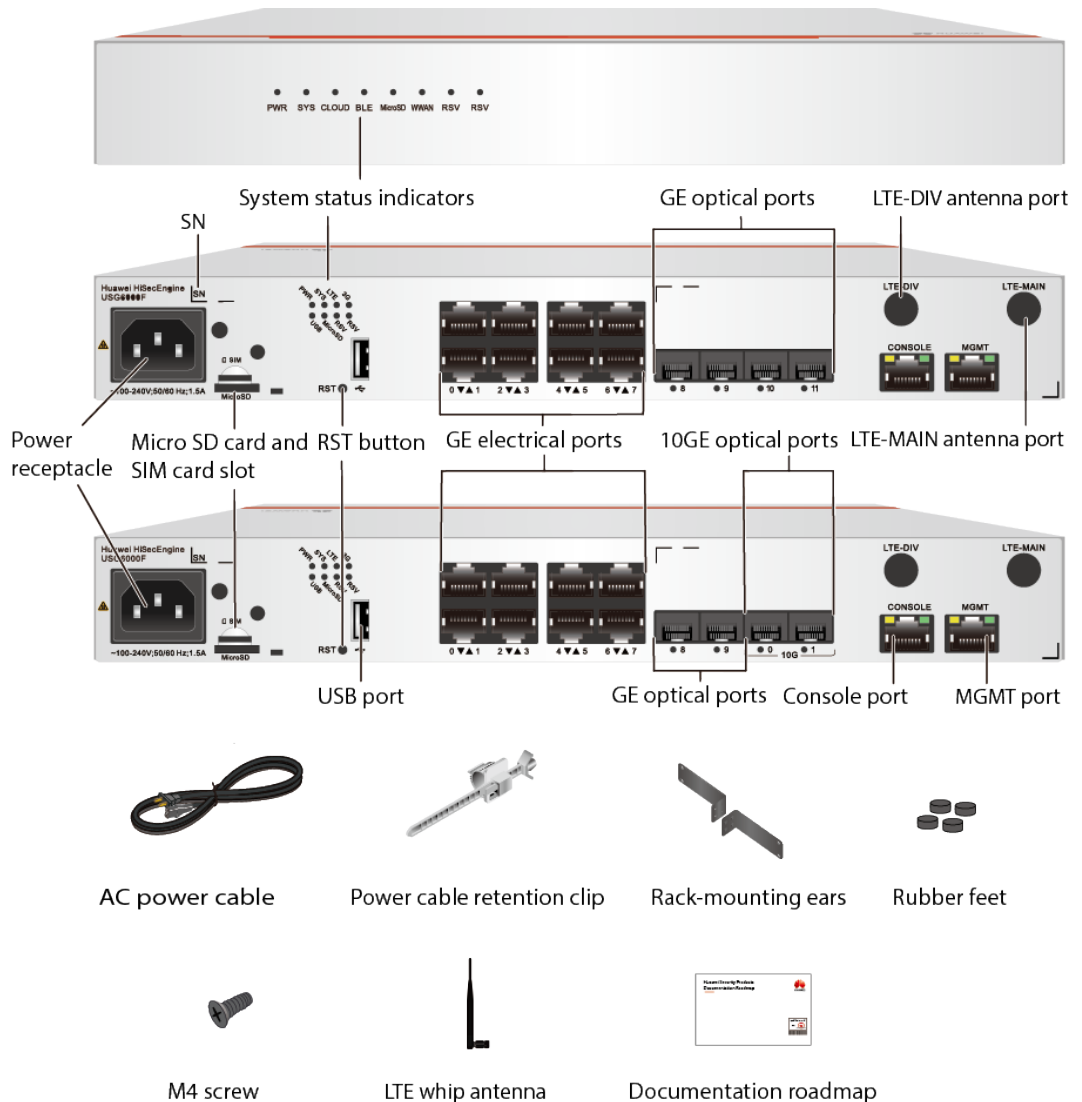

In the preceding figure, the USG6510F-DL rear panel is on the center and the USG6530F-DL rear panel is on the lower.

NOTE

- The mounting ears are optional.
- The power cable varies according to the delivery country.

Cable Connection

Connect cables according to [Figure 2](#) and power on the device. As device does not provide a power switch, it starts up immediately after receiving power. When the SYS indicator on the front panel is blinking (once every two seconds), the device is running and ready for configuration.

Figure 2-4 Connecting cables of USG6510F-DL, USG6530F-DL

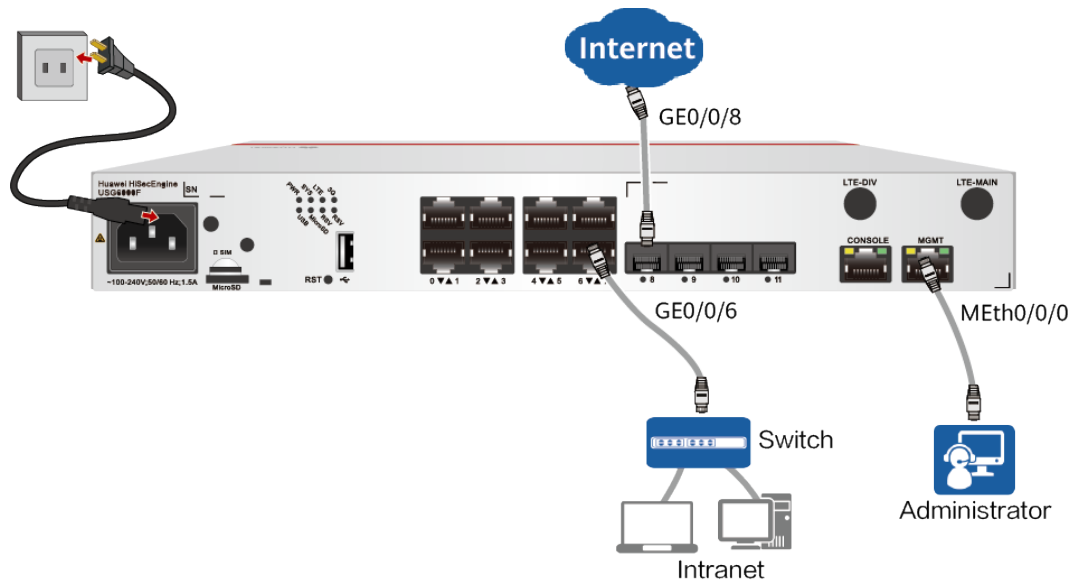

NOTE

After the power cable is installed, adjust the cable-retention clip to an appropriate position, use a cable-retention clip to bundle the cable of the power adapter, and adjust the cable-retention clip to fasten the cable.

2.3 USG6525F, USG6555F, USG6565F, USG6585F

Device and Auxiliary Materials

Figure 2-5 Appearance and auxiliary materials of the USG6525F, USG6555F, USG6565F, USG6585F

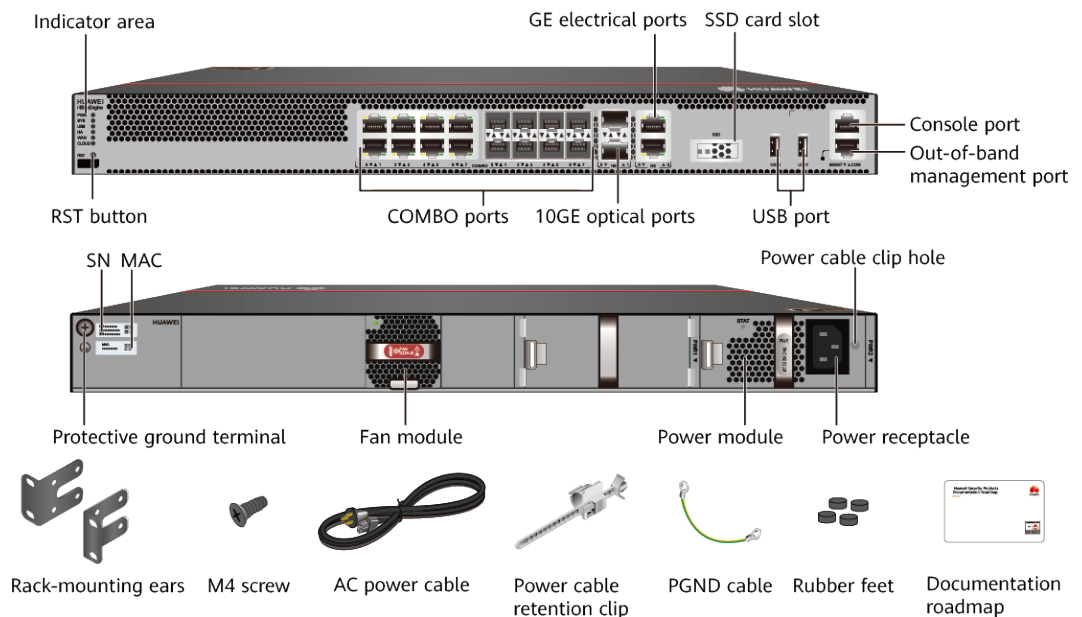

Cable Connection

Connect cables according to [Figure 2](#) and power on the device. As device does not provide a power switch, it starts up immediately after receiving power. When the SYS indicator on the front panel is blinking (once every two seconds), the device is running and ready for configuration.

Figure 2-6 Connecting cables of USG6525F, USG6555F, USG6565F, USG6585F

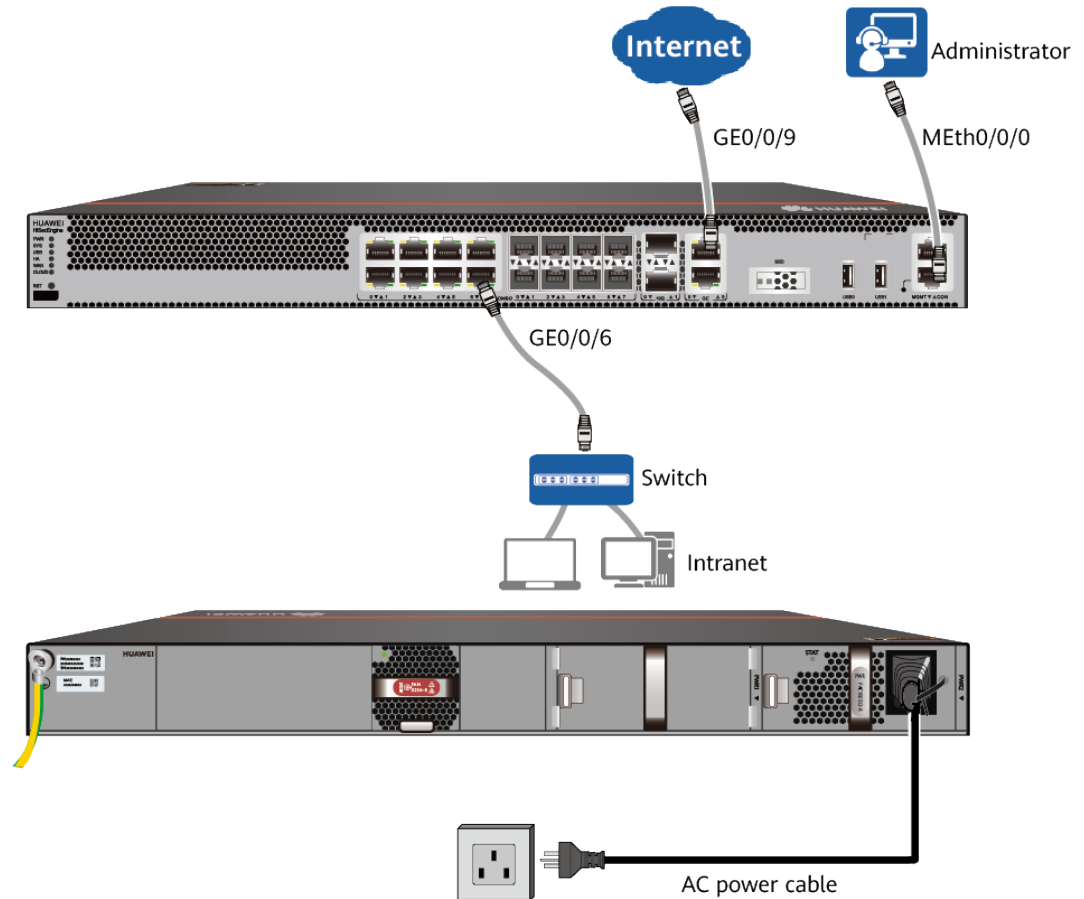

2.4 USG6525F, USG6555F, USG6565F, USG6585F, USG6615F, USG6625F

Device and Auxiliary Materials

Figure 2-7 Appearance and auxiliary materials of the USG6525F, USG6555F, USG6565F, USG6585F, USG6615F, USG6625F

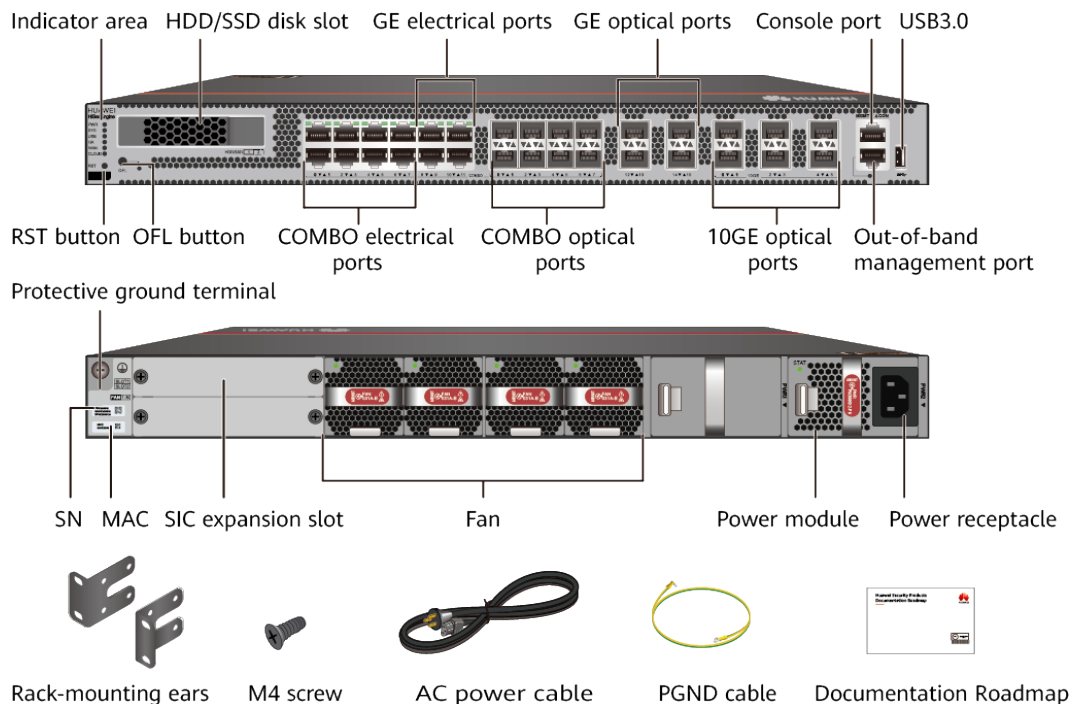

Cable Connection

Connect cables according to [Figure 2](#) and power on the device. As device does not provide a power switch, it starts up immediately after receiving power. When the SYS indicator on the front panel is blinking (once every two seconds), the device is running and ready for configuration.

Figure 2-8 Connecting cables of USG6525F, USG6555F, USG6565F, USG6585F, USG6615F, USG6625F

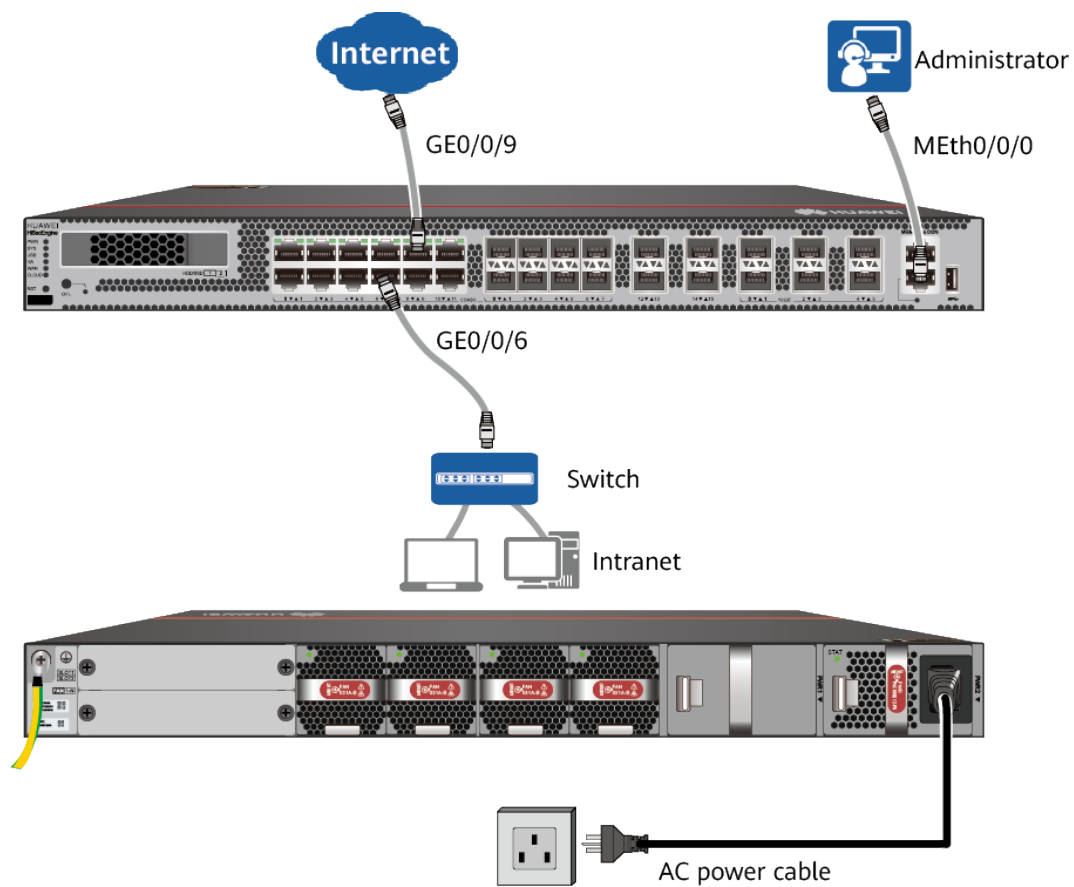

2.5 USG6635F, USG6655F, USG6685F

Device and Auxiliary Materials

Figure 2-9 Appearance and auxiliary materials of USG6635F, USG6655F, USG6685F

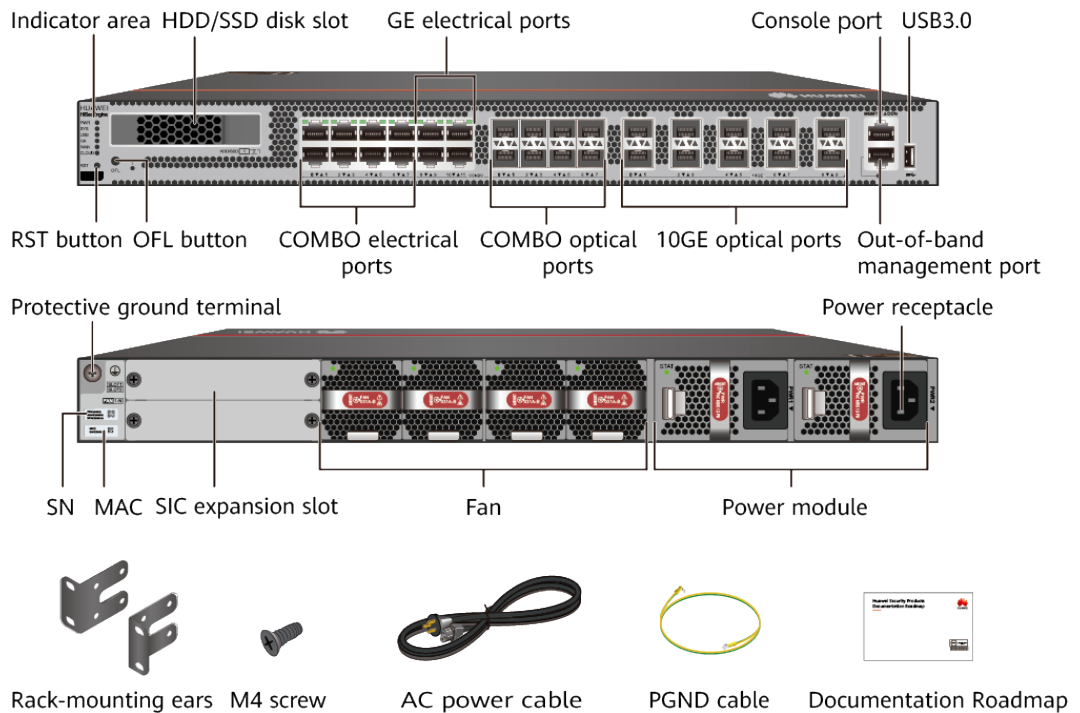

Cable Connection

Connect cables according to [Figure 2](#) and power on the device. As device does not provide a power switch, it starts up immediately after receiving power. When the SYS indicator on the front panel is blinking (once every two seconds), the device is running and ready for configuration.

Figure 2-10 Connecting cables of USG6635F, USG6655F, USG6685F

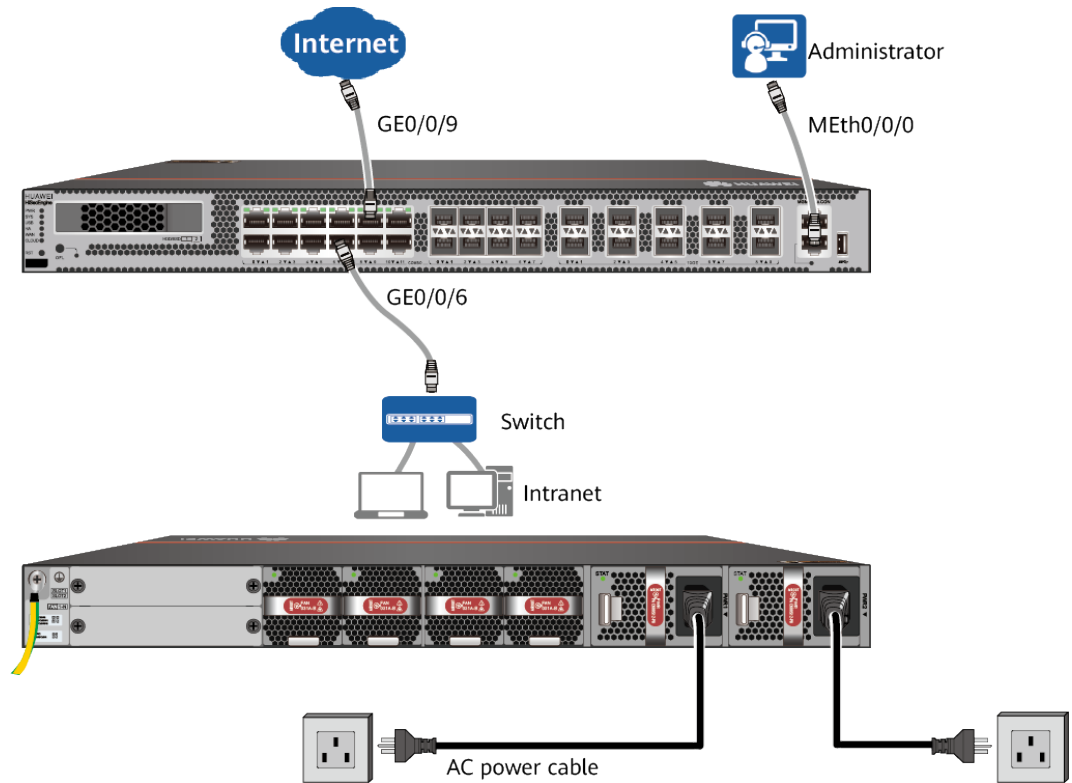

2.6 USG6710F, USG6715F

Device and Auxiliary Materials

In the preceding figure, the AC model is used as an example. The USG6715F AC and DC models differ only in the power supply mode.

Figure 2-11 Appearance and auxiliary materials of the USG6710F, USG6715F

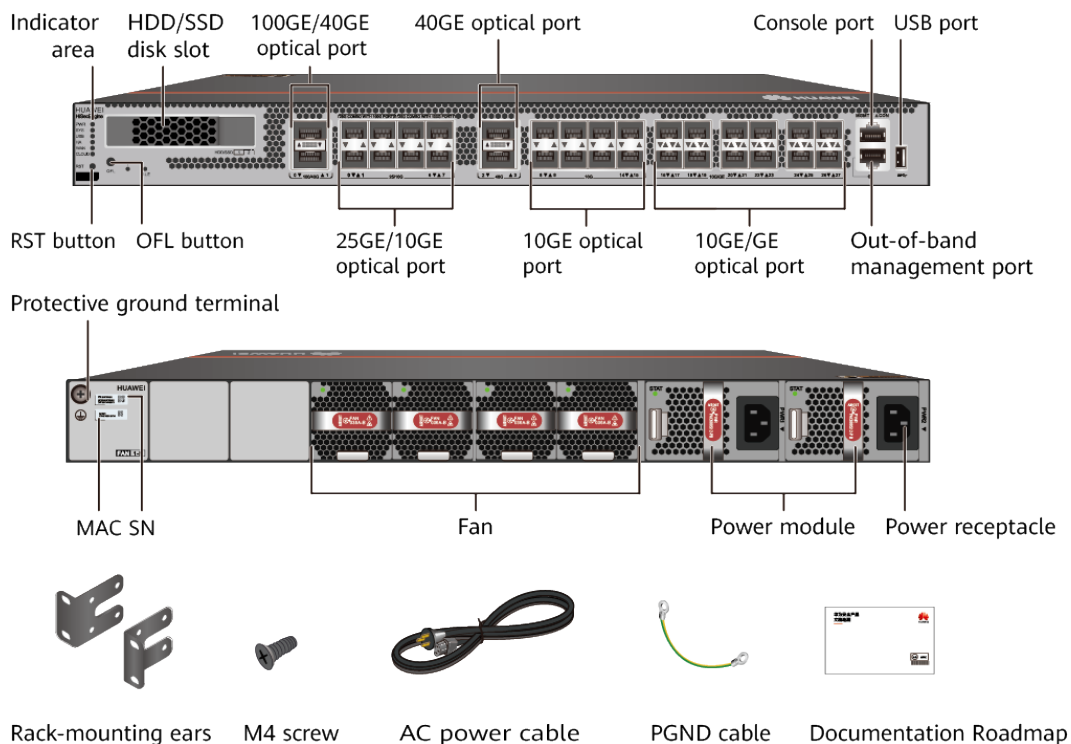

Cable Connection

Connect cables according to [Figure 2](#) and power on the device. As device does not provide a power switch, it starts up immediately after receiving power. When the SYS indicator on the front panel is blinking (once every two seconds), the device is running and ready for configuration.

Figure 2-12 Connecting cables of USG6710F, USG6715F

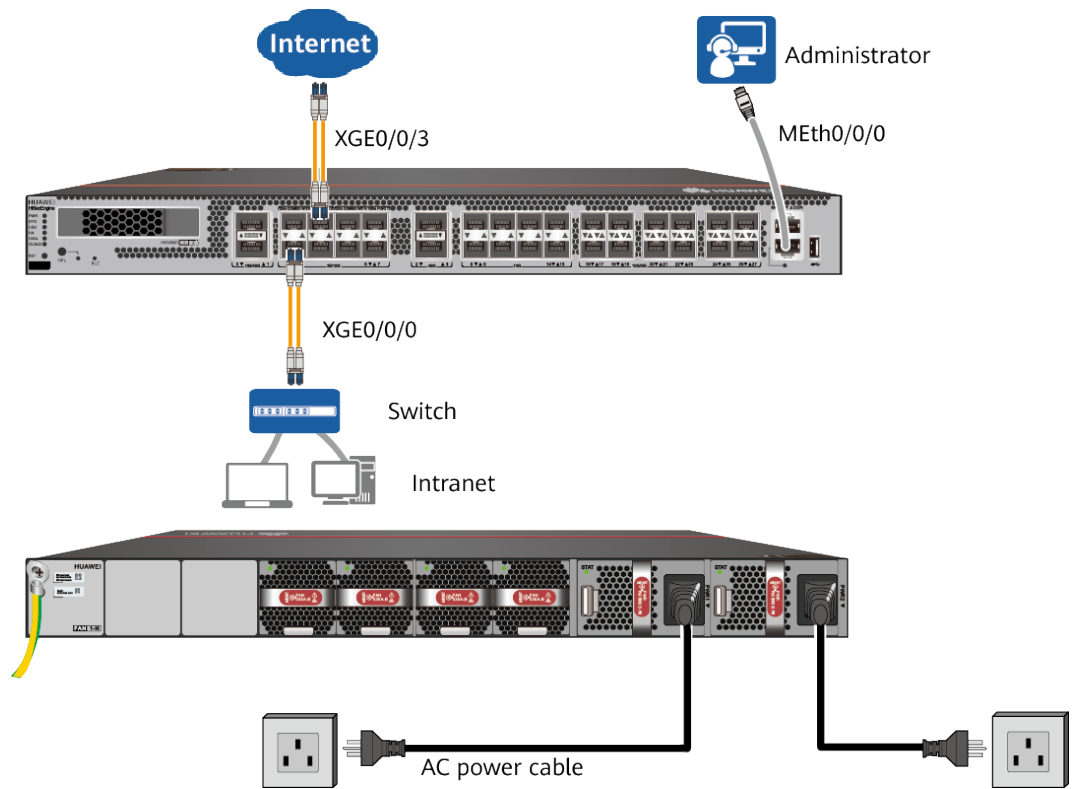

2.7 USG6725F

Device and Auxiliary Materials

Figure 2-13 Appearance and auxiliary materials of the USG6725F

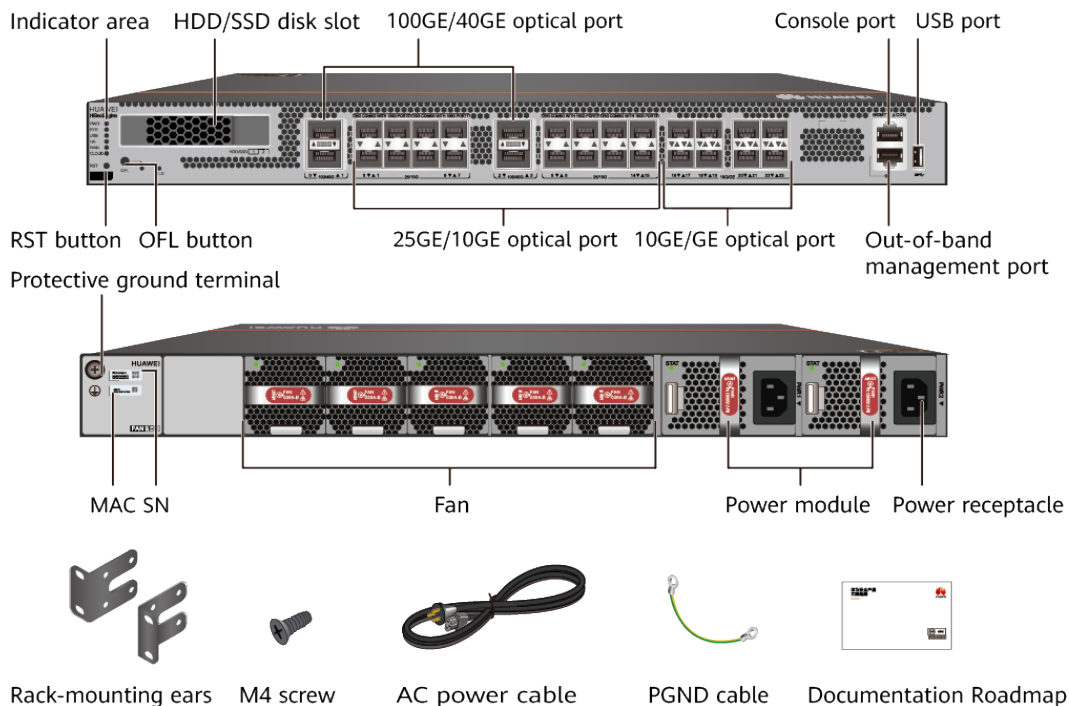

Cable Connection

Connect cables according to [Figure 2](#) and power on the device. As device does not provide a power switch, it starts up immediately after receiving power. When the SYS indicator on the front panel is blinking (once every two seconds), the device is running and ready for configuration.

Figure 2-14 Connecting cables of USG6725F

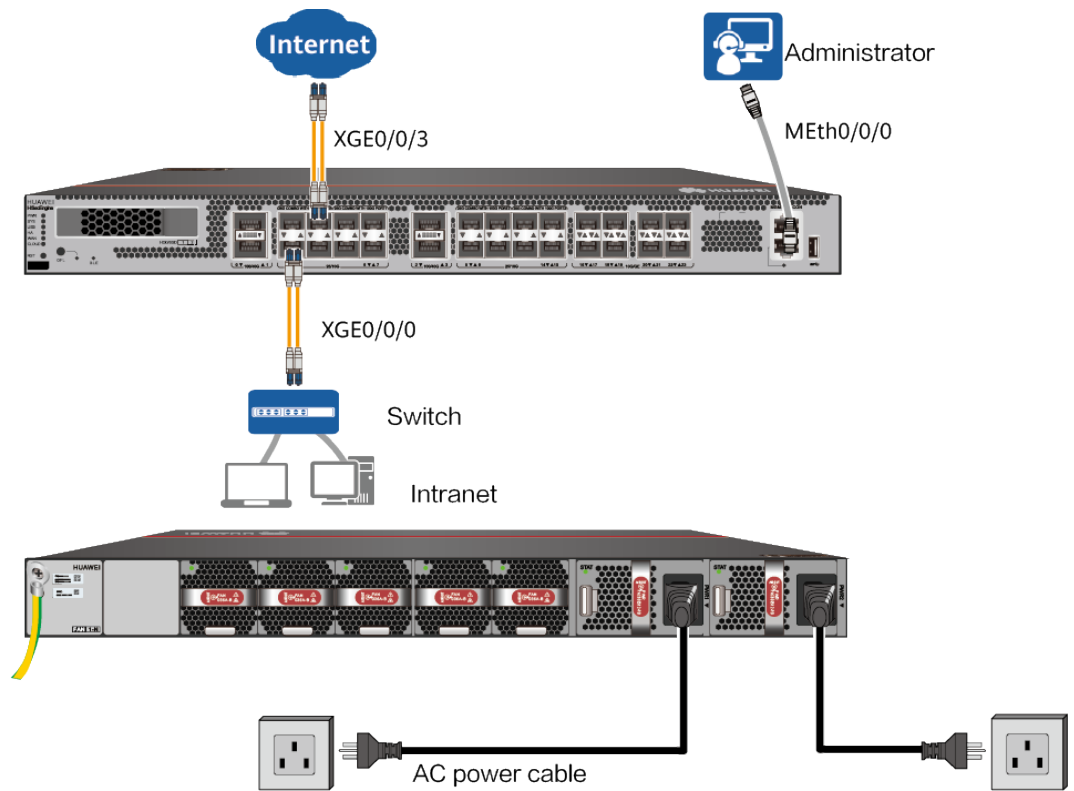

3 Accessing the Internet

Default Configuration

Table 3-1 lists the default configuration of the device.

Table 3-1 Default configuration

Item	Description
Management port	The IP address is 192.168.0.1.
Administrator account/password	No default account/password (Instead, registration is required upon your first login.)

Procedure

- Step 1** Set the IP address to 192.168.0.2 (or any other in the range of 192.168.0.2 to 192.168.0.254) and subnet mask to 255.255.255.0 of the corresponding network interface on the administration PC.
- Step 2** Open a web browser and navigate to <https://192.168.0.1:8443>.
- Step 3** Log in to the web management page of the device and register an administrator account and password as prompted.

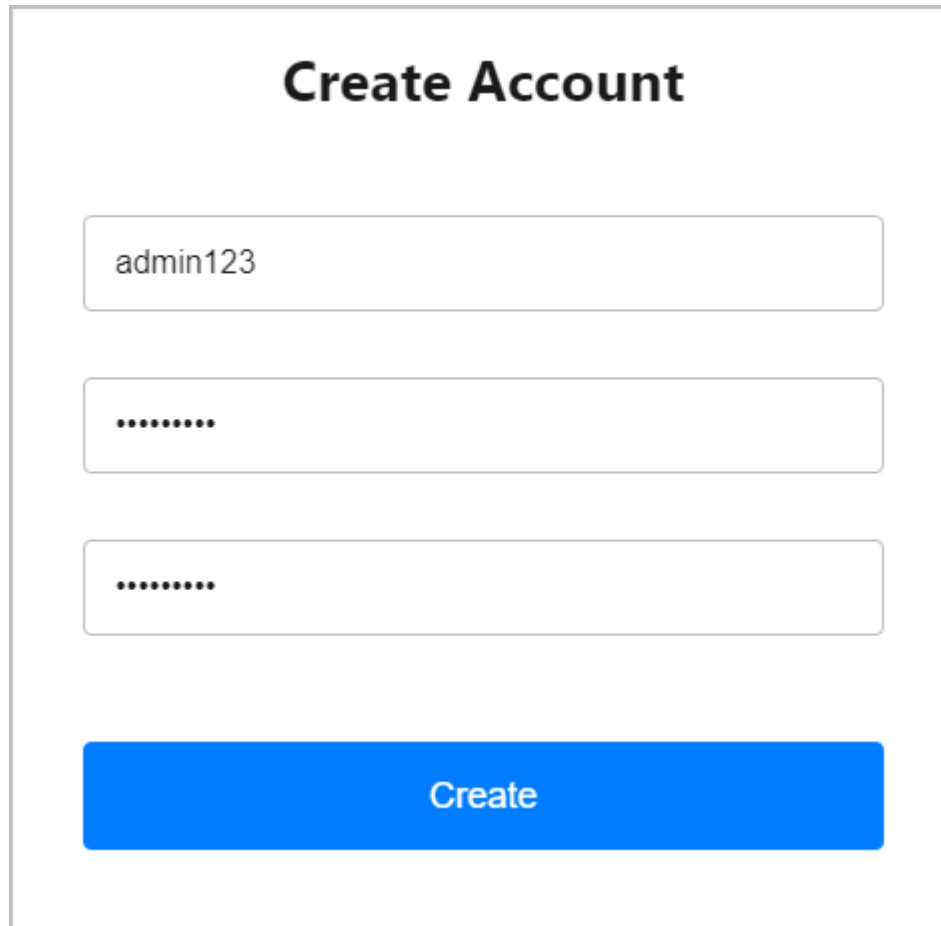

Create Account

admin123

.....

.....

Create

- Step 4** After the account is created successfully, the system displays a message prompting you to use the account to log in to the device. Click **OK**.
- Step 5** On the login page that is displayed, enter the created user name and password ,enter the captcha coad and click **Login**.

admin123

.....

f9zjd

f9zjd

Login

Download CA Certificate | English

Step 6 Entering the **Startup Wizard** page, on the **Basic Configuration** tab page, configure basic device information and system time parameters, and then click **Next**. For details about related parameters, see [Table 3-2](#).

NOTE

By default, the **Startup Wizard** page is displayed after you log in. If you do not want to enter the **Startup Wizard** page immediately after login, select **Do not show again** in the lower left corner of the page. Then the **Dashboard** page is displayed after you log in next time.

Startup Wizard

1 Basic Configuration 2 Device Deployment 3 Security Policy 4 Confirm 5 License Activation

Basic Information

* Device Name

Change Password

* Current Password

* New Password

The password must be a string of 8 to 128 characters.
Enter a password containing 4 of the following character types: uppercase letters, lowercase letters, digits, and special characters (such as !, \$, #, and %).
And the password cannot be the same as the administrator name or its reverse form.

* Confirm Password

System Time Configuration

Configuration Mode

Time Zone

Date & Time

DST Automatically adjust for daylight saving time

Start Time on the of of

End Time on the of of

⚠ The configuration data delivered through the wizard will overwrite the existing configuration data.

Do not show again.

Next Cancel

Table 3-2 Basic configuration parameters

Parameter	Description
Device Name	Host name of the device. The host name appears in the command prompt, and can be modified as required.
Change Password	Configure whether to change the administrator password for logging in to the web system. You are required to change the administrator password upon the first login.
Current Password	Enter the old password of the account.
New Password	Enter a new password.
Confirm Password	Enter the new password again. Ensure that the new passwords you entered twice are consistent.
Configuration Mode	Use one of the following methods to set the system time: <ul style="list-style-type: none"> • Manual • Synchronize with local system If you select this method, the time zone, date, and system time cannot be manually set. • Synchronize with NTP server If you select this method, you also need to set the IP address of the NTP server.

Parameter	Description
Time Zone	Select the time zone in which the device is located from the drop-down list.
Date & Time	Use either of the following methods to set the system date and time: <ul style="list-style-type: none">• Enter the system date and time in the text boxes. The date format is YYYY/MM/DD, and the time format is HH:MM:SS.• Click  and select the date and time from the calendar that is displayed.
DST	If this option is selected, the system automatically adjusts the clock for daylight saving time (DST).
Start Time	Start time of the DST. This parameter is displayed when Automatically adjust for daylight saving time is selected.
End Time	End time of the DST. This parameter is displayed when Automatically adjust for daylight saving time is selected.
Offset	DST offset. This parameter is displayed when Automatically adjust for daylight saving time is selected. For example, set Start Time to 08:00 on the first Monday in August, End Time to 10:00 on the first Monday in October, and Offset to 01:00. After the setting is complete, the system time is automatically set to 09:00:00 at 08:00:00 on the first Monday in August, and to 09:00:01 at 10:00:01 on the first Monday in October.

Step 7 On the **Device Deployment** tab page, select a device deployment mode and click **Confirm**.

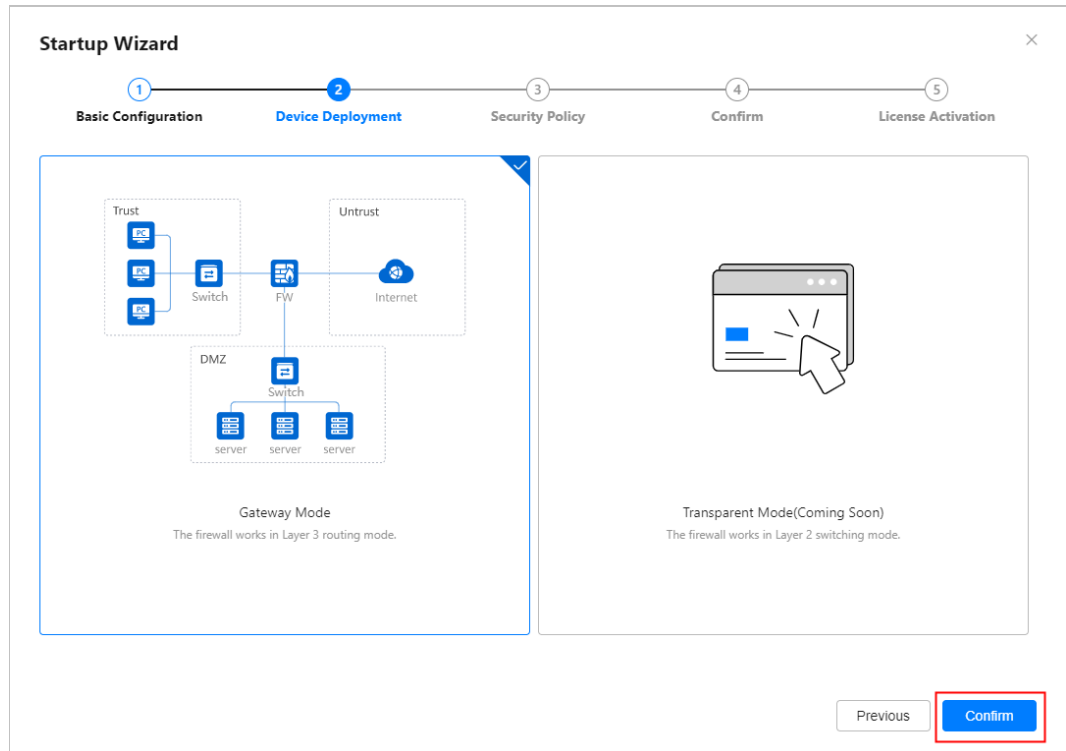

NOTE

Currently, only the **Gateway Mode** configuration wizard is supported.

Step 8 On the **Device Deployment** tab page, set network parameters. If the DMZ needs to be deployed for the device, click  to enable the DMZ configuration, set related parameters, and click **Next**. For details about related parameters, see [Table 3-3](#), [Table 3-4](#), and [Table 3-5](#).

Startup Wizard

1 Basic Configuration 2 **Device Deployment** 3 Security Policy 4 Confirm 5 License Activation

^ Internet Configuration (Untrust Zone) Configure the device to access the Internet based on the information provided by the network service provider.

* Internet Access Interface: 10GE4/0/1

Internet Access Mode: Static IP DHCP

* IP/Mask: 3.3.3.6/255.255.255.0

* Default Gateway: 10.10.10.10

* DNS1: 1.1.1.1

DNS2: 2.2.2.2

DNS3: 3.3.3.3

^ LAN Configuration (Trust Zone) Deploy a LAN so that devices on the intranet can access the Internet.

* Interface: 10GE4/0/2

* IP/Mask: 192.168.0.1/24

DHCP Server:

* IP Address Range: 192.168.0.1 - 192.168.0.10

* Subnet Mask: 255.255.255.0

Previous **Next**

Table 3-3 Parameter description for **Internet Configuration (Untrust Zone)**

Parameter	Description
Internet Access Interface	Select an interface for accessing the Internet.
Internet Access Mode	Select an Internet access mode. <ul style="list-style-type: none"> • Static IP: If you obtain a fixed IP address or an IP address range from a network service provider, select this access mode. • DHCP: If you automatically obtain IP addresses from a network service provider, select this access mode.
IP/Mask	IP address and subnet mask of the Internet access interface. This parameter is mandatory when Internet Access Mode is set to Static IP . The IP address is provided by a network service provider and is in dotted decimal notation, for example, 1.1.1.1. A typical subnet mask is similar to 255.x.x.x.

Parameter	Description
Default Gateway	<p>IP address of the default gateway of the Internet access interface. The Internet access interface sends Internet access packets from intranet users to the default gateway, which then forwards the packets. This parameter is mandatory when Internet Access Mode is set to Static IP.</p> <p>The default gateway is provided by a network service provider and is in dotted decimal notation, for example, 1.1.1.254.</p>
DNS1	<p>IP address of the primary DNS server. This parameter is mandatory when Internet Access Mode is set to Static IP.</p> <p>Hosts in the LAN need to use domain names to access websites. Therefore, you need to specify the IP address of the DNS server. This parameter is provided by a network service provider.</p>
DNS2	<p>IP address of the secondary DNS server. When the primary DNS server is faulty, the device accesses the secondary DNS server to resolve domain names.</p> <p>This parameter is provided by a network service provider.</p>
DNS3	<p>IP address of the secondary DNS server. When the primary DNS server is faulty, the device accesses the secondary DNS server to resolve domain names.</p> <p>This parameter is provided by a network service provider.</p>

Table 3-4 Parameter description for **LAN Configuration (Trust Zone)**

Parameter	Description
Interface	Select the interface connected to the LAN on the device.
IP/Mask	IP address and subnet mask of the interface connected to the LAN. A private address such as 10.0.0.1 or 192.168.0.1 is recommended.
DHCP Server	<p>Click  to enable the DHCP service on the LAN. After the DHCP service on the LAN is enabled, users on the LAN can be automatically assigned IP addresses ranging from the start IP address to the end IP address.</p> <p>Enter the start and end IP addresses to be assigned to DHCP clients next to IP Address Range. Enter the subnet mask next to Subnet Mask.</p>



Parameter	Description
NAT Policy	Click  to enable the NAT service to translate internal IP addresses into public IP addresses. The value can be Outbound interface or Address in the IP address pool .

Table 3-5 Parameter description for **DMZ Configuration(DMZ)**

Parameter	Description
DMZ Interface	Select the interface connecting the device to the DMZ.
IP/Mask	IP address and subnet mask of the interface connected to the DMZ. A private address such as 10.0.0.1 or 192.168.0.1 is recommended.

Parameter	Description
Server Mapping Configuration	<ol style="list-style-type: none"> 1. Click Add to configure server mapping and map the private IP address of the intranet server to a public IP address. 2. Click  to save the configuration. 3. (Optional) Click Configure in the Advanced column to perform advanced configuration. <ul style="list-style-type: none"> - Protocol and Port Configuration: This function is disabled by default. After this function is enabled, you can configure the protocol type used by the server to provide services for external systems, the port number provided by the server for external users, and the internal port number of the server. When Protocol is set to TCP or UDP, Public Port and Private Port are displayed. - Allow Server to Use Public IP for Internet Access: If this option is not selected, the device generates only forward server mapping entries. When the server proactively accesses the Internet, the device cannot translate the private IP address of the server into a public IP address. As a result, the server cannot initiate connections to the Internet. If this option is selected, the device generates return server mapping entries, and the server can use public IP addresses to access the Internet proactively. For security purposes, do not select this option if the server does not need to access Internet resources. - Auto Generate Blackhole Route: If this option is selected, the blackhole route to the public IP address is automatically delivered to prevent routing loops. In addition, after a dynamic routing protocol such as OSPF is configured to import static routes, public IP addresses can be advertised through the dynamic routing protocol, and the upstream and downstream routers can receive the routes to the public IP addresses. If the global address configured in NAT Server and the public network interface address are on different network segments, you must configure a blackhole route. If they are on the same network segment, you are advised to configure a blackhole route. If the IP addresses are the same, no routing loops will be generated, and the blackhole route cannot be configured.

Step 9 On the **Security Policy** tab page, set security policy parameters for the Trust zone or DMZ zone. The configuration mode can be **Basic access** or **Security protection**. Then click **Next**.

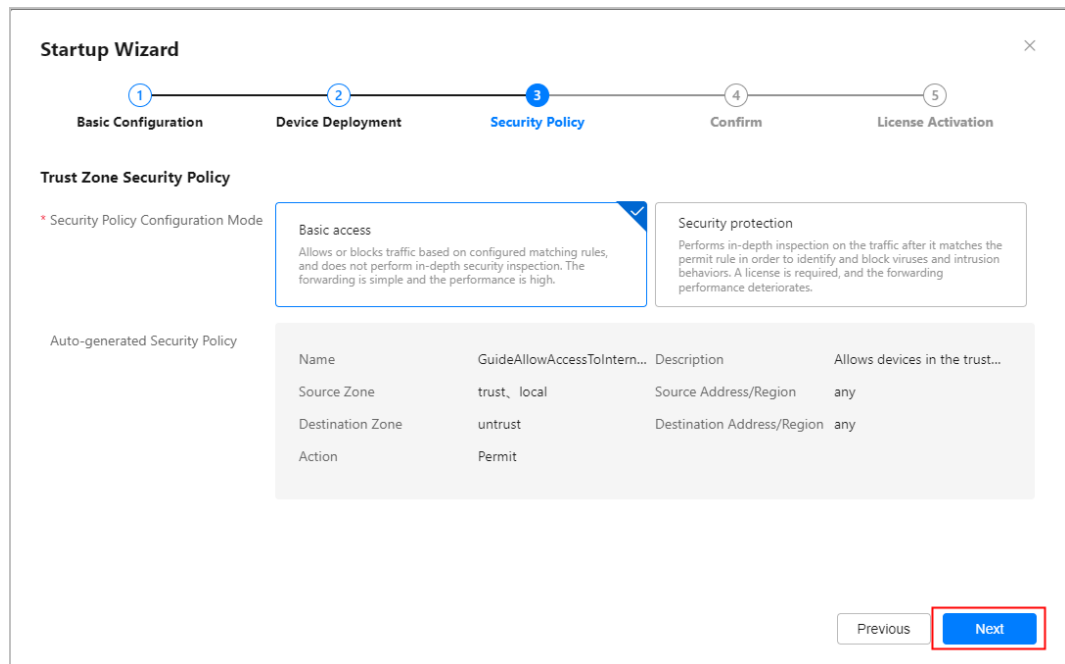

Step 10 On the **Confirm** tab page, confirm the configuration information and click **Submit**.

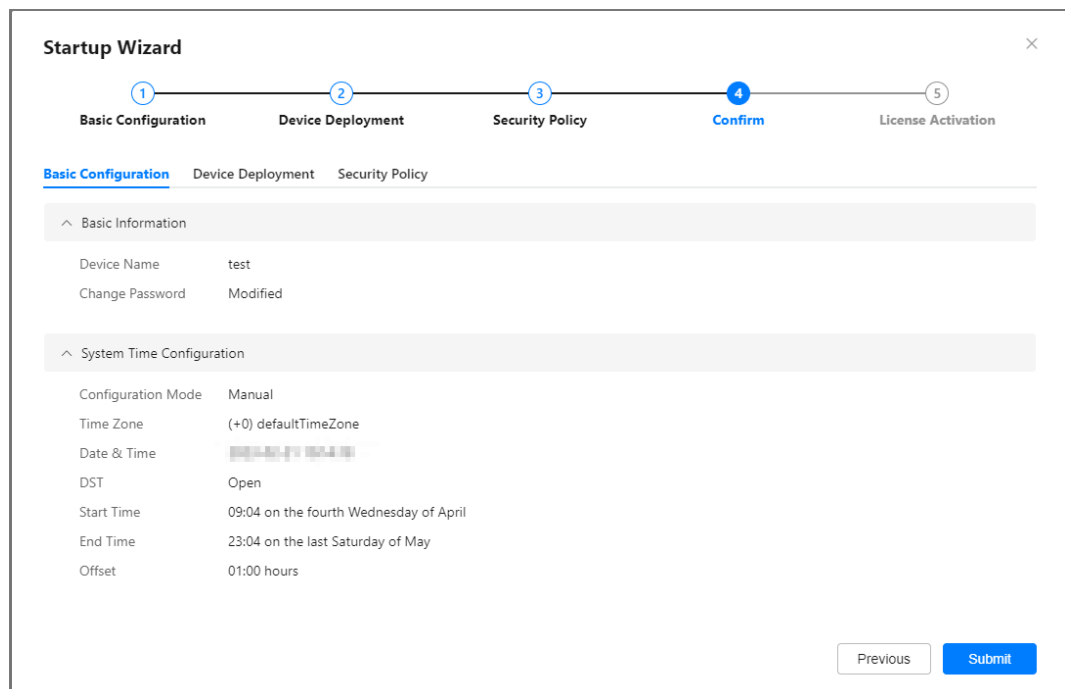

Step 11 On the **License Activation** tab page, click **Browse** to upload a license file. Click **Activate**. After the basic license is activated, click **Complete**.

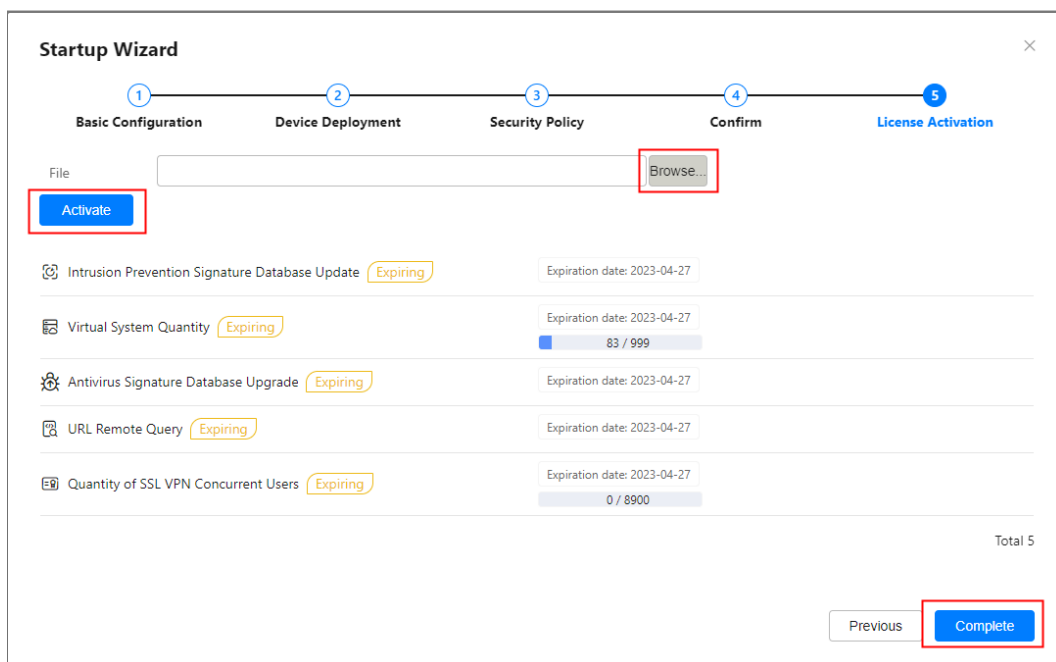

Step 12 After the configuration is complete, choose **System > Startup Wizard** to access the configuration wizard page again.

----End

4 Appendix

4.1 Supplier's Declaration of Conformity (SDoC)

Unique Identifier: trade name: HUAWEI; product name: Firewall; model number: USG6000F

Responsible Party- U.S. Contact Information

Huawei Technologies USA Inc. 5700 Tennyson Parkway, Suite 500

Plano, Texas 75024

Main: 214-919-6000 / TAC Hotline: 877-448-2934

FCC Compliance Statement (for products subject to Part 15)

This device complies with part 15 of the FCC Rules. Operation is subject to the following two conditions:

- (1) This device may not cause harmful interference, and
- (2) this device must accept any interference received, including interference that may cause undesired operation.

4.2 Obtaining Product Documents and Technical Support

- Log in to <https://support.huawei.com/weiknow/?lang=en> to ask questions online.
- Log in to [Support-E](#), and select a specific product model and version to find its documentation.
- Log in to the Info-Finder website [Info-Finder](#), view the hardware and software specifications of the device based on the product model and version information.
- Log in to <https://forum.huawei.com/enterprise> and post your questions in the community.

- Contact your local representative for further information.

 **NOTE**

The contact information is available at <https://e.huawei.com/en/service-hotline>.