



DS-AT1000S Series Storage System  
Quick Start Guide

# TABLE OF CONTENTS

<b>Chapter 1 Working Environment and Installation .....</b>	<b>5</b>
1.1 Environment of Equipment Room.....	5
1.1.1 Power Supply System .....	5
1.1.2 Temperature and Humidity of Equipment Room.....	5
1.2 Installation and Initial Power-on .....	7
1.3 Notes for Installation.....	7
<b>Chapter 2 Appearance and Installation .....</b>	<b>8</b>
2.1 Device Appearance.....	8
2.1.1 Chassis Overall View .....	8
2.1.2 Front Panel .....	8
2.1.3 Description of Buttons in Front Panel .....	9
2.1.4 Rear Panel .....	11
2.2 Install Accessories .....	13
2.2.1 Installation Requirement.....	13
2.2.2 Install HDD.....	14
2.3 Startup.....	16
2.4 Shutdown .....	17
<b>Chapter 3 Function Configuration .....</b>	<b>18</b>
<b>Chapter 4 Network.....</b>	<b>19</b>
4.1 Activate Storage System .....	19
4.2 Configure Network Parameters.....	19
4.2.1 Modify Network Parameters.....	19
4.2.2 Modify IP Address of Bond Network Interface .....	21
<b>Chapter 5 System Configuration.....</b>	<b>22</b>
5.1 One-Key Configuration .....	22
5.2 Format Storage Space .....	23
5.2.1 Activate Hybrid SAN Sub-System .....	23
5.2.2 Format Storage Space .....	24
<b>Chapter 6 Basic Configuration.....</b>	<b>25</b>
6.1 Camera Management.....	25
6.2 Configure Recording Schedule .....	26
6.3 Live View .....	27
6.4 Playback.....	27

### **Quick Start Guide**

COPYRIGHT ©2019 Hangzhou Hikvision Digital Technology Co., Ltd.

#### **ALL RIGHTS RESERVED.**

Any and all information, including, among others, wordings, pictures, graphs are the properties of Hangzhou Hikvision Digital Technology Co., Ltd. or its subsidiaries (hereinafter referred to be “Hikvision”). This user manual (hereinafter referred to be “the Manual”) cannot be reproduced, changed, translated, or distributed, partially or wholly, by any means, without the prior written permission of Hikvision. Unless otherwise stipulated, Hikvision does not make any warranties, guarantees or representations, express or implied, regarding to the Manual.

#### **About this Manual**

This Manual is applicable to DS-AT1000S Series Storage System.

The Manual includes instructions for using and managing the product. Pictures, charts, images and all other information hereinafter are for description and explanation only. The information contained in the Manual is subject to change, without notice, due to firmware updates or other reasons. Please find the latest version in the company website (<http://overseas.hikvision.com/en/>).

Please use this user manual under the guidance of professionals.

#### **Trademarks Acknowledgement**

**HIKVISION** and other Hikvision’s trademarks and logos are the properties of Hikvision in various jurisdictions. Other trademarks and logos mentioned below are the properties of their respective owners.

#### **Legal Disclaimer**

TO THE MAXIMUM EXTENT PERMITTED BY APPLICABLE LAW, THE PRODUCT DESCRIBED, WITH ITS HARDWARE, SOFTWARE AND FIRMWARE, IS PROVIDED “AS IS”, WITH ALL FAULTS AND ERRORS, AND HIKVISION MAKES NO WARRANTIES, EXPRESS OR IMPLIED, INCLUDING WITHOUT LIMITATION, MERCHANTABILITY, SATISFACTORY QUALITY, FITNESS FOR A PARTICULAR PURPOSE, AND NON-INFRINGEMENT OF THIRD PARTY. IN NO EVENT WILL HIKVISION, ITS DIRECTORS, OFFICERS, EMPLOYEES, OR AGENTS BE LIABLE TO YOU FOR ANY SPECIAL, CONSEQUENTIAL, INCIDENTAL, OR INDIRECT DAMAGES, INCLUDING, AMONG OTHERS, DAMAGES FOR LOSS OF BUSINESS PROFITS, BUSINESS INTERRUPTION, OR LOSS OF DATA OR DOCUMENTATION, IN CONNECTION WITH THE USE OF THIS PRODUCT, EVEN IF HIKVISION HAS BEEN ADVISED OF THE POSSIBILITY OF SUCH DAMAGES.

REGARDING TO THE PRODUCT WITH INTERNET ACCESS, THE USE OF PRODUCT SHALL BE WHOLLY AT YOUR OWN RISKS. HIKVISION SHALL NOT TAKE ANY RESPONSIBILITIES FOR ABNORMAL OPERATION, PRIVACY LEAKAGE OR OTHER DAMAGES RESULTING FROM CYBER ATTACK, HACKER ATTACK, VIRUS INSPECTION, OR OTHER INTERNET SECURITY RISKS; HOWEVER, HIKVISION WILL PROVIDE TIMELY TECHNICAL SUPPORT IF REQUIRED.

SURVEILLANCE LAWS VARY BY JURISDICTION. PLEASE CHECK ALL RELEVANT LAWS IN YOUR JURISDICTION BEFORE USING THIS PRODUCT IN ORDER TO ENSURE THAT YOUR USE CONFORMS THE APPLICABLE LAW. HIKVISION SHALL NOT BE LIABLE IN THE EVENT THAT THIS PRODUCT IS USED WITH ILLEGITIMATE PURPOSES.

IN THE EVENT OF ANY CONFLICTS BETWEEN THIS MANUAL AND THE APPLICABLE LAW, THE LATER PREVAILS.

## Regulatory Information

### FCC Information

**FCC compliance:** This equipment has been tested and found to comply with the limits for a Class A digital device, pursuant to part 15 of the FCC Rules. These limits are designed to provide reasonable protection against harmful interference when the equipment is operated in a commercial environment. This equipment generates, uses, and can radiate radio frequency energy and, if not installed and used in accordance with the instruction manual, may cause harmful interference to radio communications. Operation of this equipment in a residential area is likely to cause harmful interference in which case the user will be required to correct the interference at his own expense.

The device is advised to note that as a seller or a business user (Class A) Devices and intended for use outside the Home area.

### FCC Conditions

This device complies with part 15 of the FCC Rules. Operation is subject to the following two conditions:

1. This device may not cause harmful interference.
2. This device must accept any interference received, including interference that may cause undesired operation.

### EU Conformity Statement

 This product and - if applicable - the supplied accessories too are marked with "CE" and comply therefore with the applicable harmonized European standards listed under the EMC Directive 2014/30/EU, the RoHS Directive 2011/65/EU, the LVD Directive 2014/35/EU.

 2012/19/EU (WEEE directive): Products marked with this symbol cannot be disposed of as unsorted municipal waste in the European Union. For proper recycling, return this product to your local supplier upon the purchase of equivalent new equipment, or dispose of it at designated collection points. For more information see: [www.recyclethis.info](http://www.recyclethis.info)

 2006/66/EC (battery directive): This product contains a battery that cannot be disposed of as unsorted municipal waste in the European Union. See the product documentation for specific battery information. The battery is marked with this symbol, which may include lettering to indicate cadmium (Cd), lead (Pb), or mercury (Hg). For proper recycling, return the battery to your supplier or to a designated collection point. For more information see: [www.recyclethis.info](http://www.recyclethis.info)

### Industry Canada ICES-003 Compliance

This device meets the CAN ICES-3 (A)/NMB-3(A) standards requirements.



## Applicable Models

This manual is applicable to the models listed in the following table.

Series	Model
DS-AT1000S series	DS-AT1000S/160
	DS-AT1000S/240
	DS-AT1000S/300
	DS-AT1000S/320
	DS-AT1000S/360
	DS-AT1000S/440
	DS-AT1000S/480

## Symbol Conventions

The symbols that may be found in this document are defined as follows.

Symbol	Description
 <b>NOTE</b>	Provides additional information to emphasize or supplement important points of the main text.
 <b>WARNING</b>	Indicates a potentially hazardous situation, which if not avoided, could result in equipment damage, data loss, performance degradation, or unexpected results.
 <b>DANGER</b>	Indicates a hazard with a high level of risk, which if not avoided, will result in death or serious injury.

# Chapter 1 Working Environment and Installation

Devices described in this manual should be installed in the standard equipment room.

## 1.1 Environment of Equipment Room

### 1.1.1 Power Supply System

The storage system is sensitive to the change of a voltage, and an excessively high or low voltage, or a sudden change of the voltage may delete the data in the memory or even cause the damage of the components. To avoid of such damage, you must ensure the power supply is stable and grounded. You are recommended to use the UPS, or the multiple power supply if permitted.

- The voltage should be  $220V \pm 4\%$ , the sudden change should be  $220V \pm 15\%$ , and frequency should be  $50Hz \pm 0.5Hz$ .
- Make the neutral line and GND line connections correct, and the voltage between them must be less than 1 V.
- Grounding for AC power supply system: ensure the GND line is properly connected. The grounding for the chassis is recommended.
- Grounding for DC power supply system: the chassis must be properly grounded.
- Connect all power cords before applying power to the redundant power supply module.

### 1.1.2 Temperature and Humidity of Equipment Room

Item	Requirement
Working temperature	5 °C to 40 °C (41 °F to 104 °F)
temperature equipment room	21 °C $\pm$ 25 °C (69.8 °F $\pm$ 77 °F)
Storage temperatue	-40 °C to +70 °C (-40 °F to +158 °F)
Temperature change rate	< 5 °C/h (non-condensing)
Working humidity	20% RH to 80% RH
Storage humidity	5% RH to 95% RH
Location	Equipment room should be dust-free, and away from harmful gas, and inflammable and explosive objects. Environment with electromagnetic interference, strong virbation, noise, and unstable voltage is also not recommended.

Construction	The area of the equipment room should meet the requirements of equipment installation and capacity expansion. And the ground can bear product loading. The rooting facilities should be well designed and ready.
Air conditioner	Install an air conditioner which supports power off restart function in the machine room. The installation position of air conditioning should ensure no air will blow to the equipment directly.
Ventilation and heat dissipation	To guarantee the equipments can be well ventilated, the distance between the cabinet and the wall shall not be less than 100 cm, and the distance between two cabinets shall not be less than 120 cm. It is recommended to reserver 1U space between two equipments. Ensure aire can effectively convect between the cabinet and the equipment room.
Dust-free	For the equipment room locating near the dust source (coal mine, rural road, farmland, etc.), the windows and doors should be able to keep out the wind and sand.
Transportation	Pack the equipment into the package. Do not transport via open truck or open warehouse. And do not transport the equipment with inflammable, explosive, and corrosive goods. Protect the equipment from rain, dust, and damage.
Particulate pollutant	$\geq 0.5 \mu\text{m}$ . Dust in static air should be less than 18,000 in each litre.
Corrosive gas concentration	The corrosion rate of copper test plate must be lower than 300 Åc in each month. (According to the requirements of G1 level on corrosive gas in ANSId/ISAE-71.04-1985 standard)
Floor bearing capability	Floor load-bearing capability requirement is 600 kg/m <sup>2</sup> . The height from the floor to the ceiling should be larger than 2.7M. The required load-bearing capacity for the rack is 10 KG multiply by device chassis size. E.g., a 4U equipment requires 40 KG bearing capability.
Vertical and horizontal vibration acceleration on floor surface	When the equipment is halted, acceleration value should not be larger than 0.5m/S <sup>2</sup> .
Grounding	Ensure that each equipment is grounded. Serial grounding is not allowd. The resistance between the equipment shell and earth must be less than 4 Ω.
Å is a length unit. 1 Å = 1/10,000,000,000 m	

## 1.2 Installation and Initial Power-on

- The device shall be placed on the fixed flat surface. Tilting surface is not allowed.
- You can use the standard plate in the industrial cabinet or use the guide rail (not provided) to install the device to the rack. It is recommended to use the bolts to fix the device to the rack through the mounting screw holes on the rack.
- Connect all the power cords of the device to the power socket and wait for 12 hours before starting up. The temperature of the device and the equipment room must be consistent to prevent the damage caused by a huge temperature difference.
- If the device has been transported and stored for more than 10 days; perform the previous operation and then start up and run the device for 30 minutes without the hard disks. And then you shut down the device, insert the hard disks and start the device again.

## 1.3 Notes for Installation

- The device is a high-precision equipment. Please keep stable and gentle when moving it.
- Installation and running environment must meet standards. Take regular investigations and records for the equipment room, or apply a remote monitoring for the working status of the device.
- Do not unplug the power cord when the device is running.
- In case of alarm beeper produced during the system running, please take immediate check and solution.



## Chapter 2 Appearance and Installation

### 2.1 Device Appearance

The system adopts rack-mounted chassis which provides LED indicators for the system status.

#### 2.1.1 Chassis Overall View



Figure 2-1 Overall View of DS-AT1000S/360, DS-AT1000S/440, and DS-AT1000S/480



Figure 2-2 Overall View of DS-AT1000S/160, DS-AT1000S/240, DS-AT1000S/300, and DS-AT1000S/320

#### 2.1.2 Front Panel

The disk slots view of the device is shown below.

Hard disks of 3.5 inches are supported. As shown above, slot order obeys the principle of left to right and bottom to top. The HDDs in bottom floor, from left to right, are HDD ①~④. The HDDs in second floor, from left to right, are HDD ⑤~⑧. And so on.



Figure 2-3 Front Panel of DS-AT1000S/360, DS-AT1000S/440, and DS-AT1000S/480



Figure 2-4 Front Panel of DS-AT1000S/160, DS-AT1000S/240, DS-AT1000S/300, and DS-AT1000S/320

### 2.1.3 Description of Buttons in Front Panel

#### DS-AT1000S/360, DS-AT1000S/440, and DS-AT1000S/480

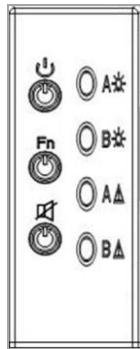









Figure 2-5 Front Panel Buttons

Figure 2-6 Button Description

Button	Name	Description
	Power switch and indicator	<ul style="list-style-type: none"> <li>When the system is off, press the button to turn on it.</li> <li>When the system is running, hold the button for at least 4s and not more than 15s to turn off the</li> </ul>

		<p>system.</p> <ul style="list-style-type: none"> <li>• The indicator shows green when the system is running.</li> </ul>
	Positioning button and indicator	<ul style="list-style-type: none"> <li>• Press this button or click <b>Positioning</b> on GUI to trigger locating function. Press the button again to disable locating function.</li> <li>• The indicator flashes in blue when locating function is triggered.</li> </ul>
	Mute button and alarm indicator	When an alarm is triggered, the indicator flashes in red and buzzer beeps. Press the button to stop beeping.
	Power indicator for controller A	When controller A is connected and is running, the indicator is green.
	Power indicator for controller B	When controller B is connected and is running, the indicator is green.
	Fault indicator for controller A	<ul style="list-style-type: none"> <li>• When a fault occurs in controller A, the indicator flashes in red.</li> <li>• When controller A does not exit, the indicator is unlit.</li> </ul>
	Fault indicator for controller B	<ul style="list-style-type: none"> <li>• When a fault occurs in controller B, the indicator flashes in red.</li> <li>• When controller B does not exit, the indicator is unlit.</li> </ul>

DS-AT1000S/160, DS-AT1000S/240, DS-AT1000S/300, and DS-AT1000S/320

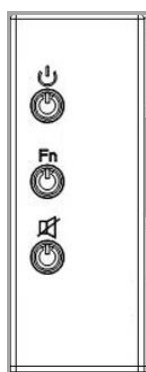





Figure 2-7 Front Panel Buttons

Figure 2-8 Button Description

Button	Name	Description
--------	------	-------------

	<p>Power switch and indicator</p>	<ul style="list-style-type: none"> <li>• When the system is off, press the button to turn on it.</li> <li>• When the system is running, hold the button for at least 4s and not more than 15s to turn off the system.</li> <li>• The indicator shows green when the system is running.</li> </ul>
	<p>Positioning button and indicator</p>	<ul style="list-style-type: none"> <li>• Press this button or click <b>Positioning</b> on GUI to trigger locating function. Press the button again to disable locating function.</li> <li>• The indicator flashes in blue when locating function is triggered.</li> </ul>
	<p>Mute button and alarm indicator</p>	<p>When an alarm is triggered, the indicator flashes in red and buzzer beeps. Press the button to stop beeping.</p>

### 2.1.4 Rear Panel

DS-AT1000S/360, DS-AT1000S/440, and DS-AT1000S/480

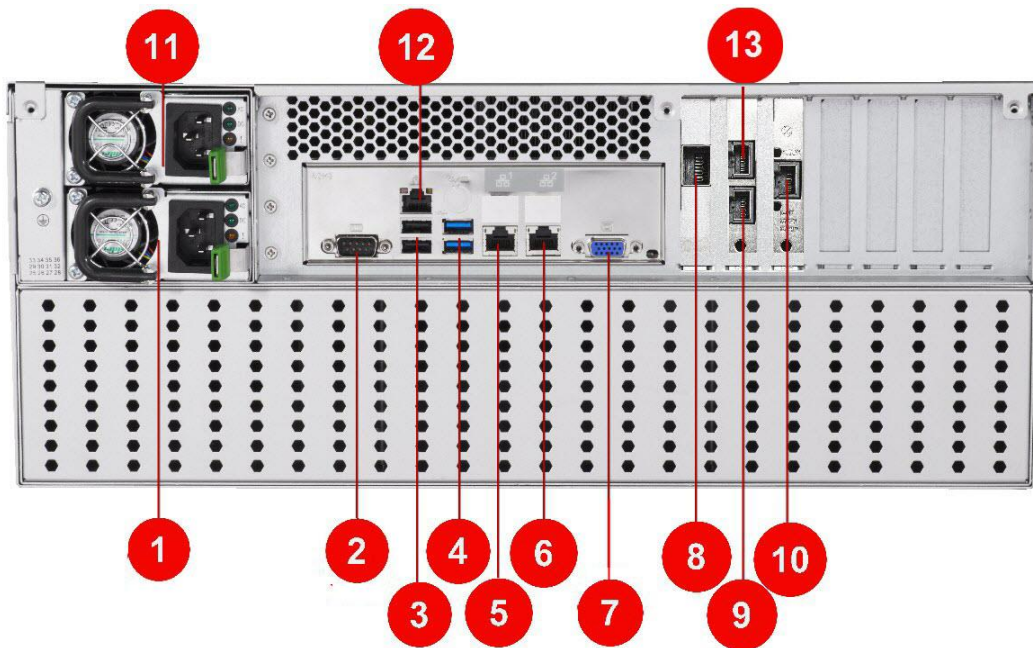

Figure 2-9 Rear Panel

Table 2-1 Description

No.	Name	No.	Name
1	Power module 1	8	SAS interface
2	COM interface	9	Data network interface 3
3	Two USB interfaces	10	Management network interface
4	Two USB interfaces	11	Power module 2
5	Data network interface 1	12	IPMI
6	Data network interface 2	13	Data network interface 4
7	VGA interface		

DS-AT1000S/160, DS-AT1000S/240, DS-AT1000S/300, and DS-AT1000S/320

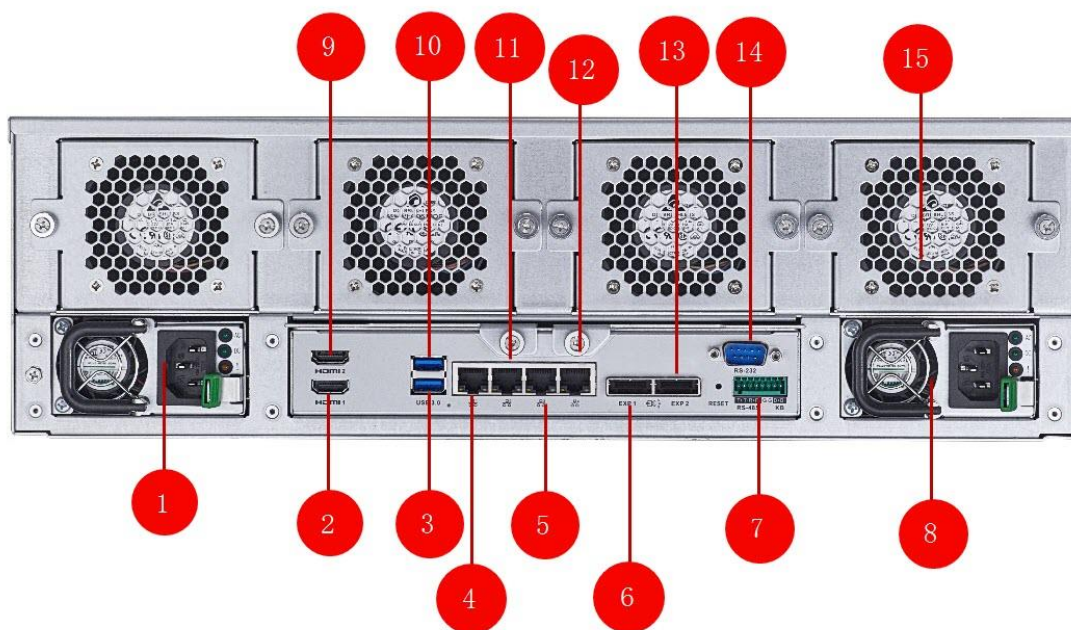

Figure 2-10 Rear Panel

Table 2-2 Description

No.	Name	No.	Name
1	Power module 1	9	HDMI interface 2
2	HDMI interface 1	10	USB interface 2
3	USB interface 1	11	Data LAN 2
4	Data LAN 1	12	Management LAN
5	Data LAN 3	13	EXP interface 2
6	EXP interface 1	14	RS-232 interface
7	RS-485 interface	15	Fan module
8	Power module 2		

## 2.2 Install Accessories

### 2.2.1 Installation Requirement

Before installation, please check whether following objects are in the package.

- Storage system
- Power cord
- Gigabit Ethernet cable
- Delivered CD
- Screw package

The following accessories are optional or user-provided:

- Gigabit Ethernet switch
- Rack guide rail

Following the installation requirements to install the storage system. Before powering on your storage system, please check the following hardware connection:

- Connect the power cord to 220 VAC power supply.
- Use the delivered Ethernet cable to connect all data network interfaces to a gigabit network switch.
- Serial port of the storage system, if any, is mainly designed for debugging. You are recommended to use it with the help of our technical support.

## 2.2.2 Install HDD

### Selecting HDD Model

It is recommended to adopt the certificated professional HDD models so as to ensure the stable running of the system and the reliable data storage. You are recommended to use the HDD in recommended HDD list. Please contact our technical support for the recommended HDD list.



In order to avoid damages during transportation, it is recommended to package and transport the hard disks separately with the chassis of network storage system.

### Installing HDD

Follow the steps below to install HDDs.

Step 1 Remove the front panel cover.

- 1) Unlock the front panel cover with delivered key.
- 2) Hold the cover and pull it out till it gets out of the control of the lock.
- 3) Move the cover to right to remove it from front panel.

Step 2 Press the spring lock of the HDD on the left, drag the handle and then pull out the dummy HDD from the chassis along the guide rail.

Step 3 (Optional) Remove the baffle, if any, from the dummy HDD.

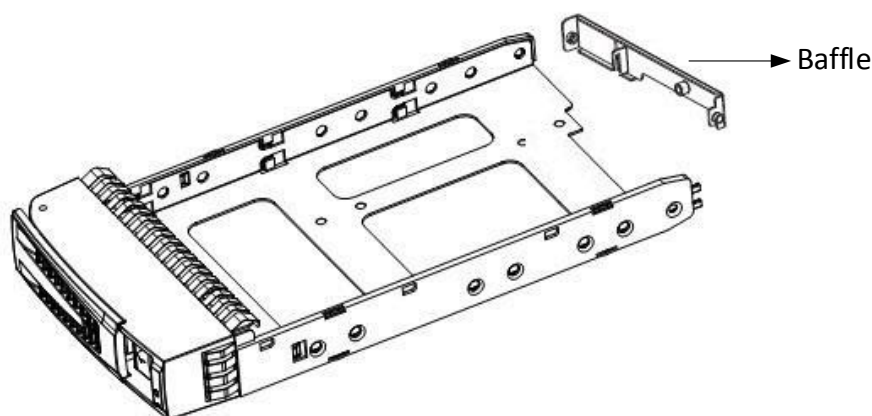

Figure 2-11 Remove Baffle

Step 4 Use four screws to secure the HDD (with the PCB side downward) to the bracket. In order to ensure the HDD pin holds the line with the rear of the plate, mount screws to the specific screw hole as shown.

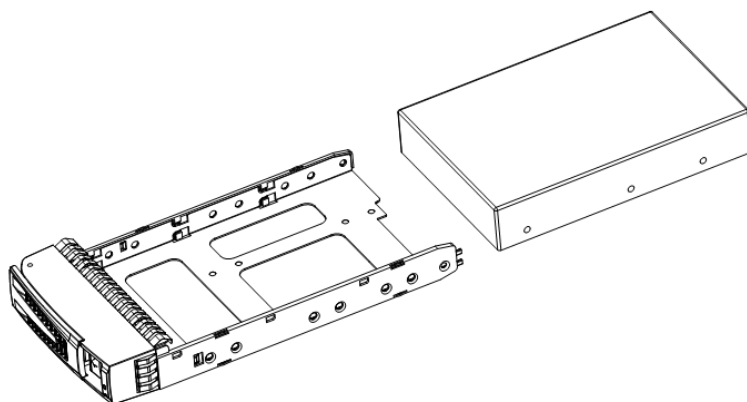

Figure 2-12 Splitting HDD Plate

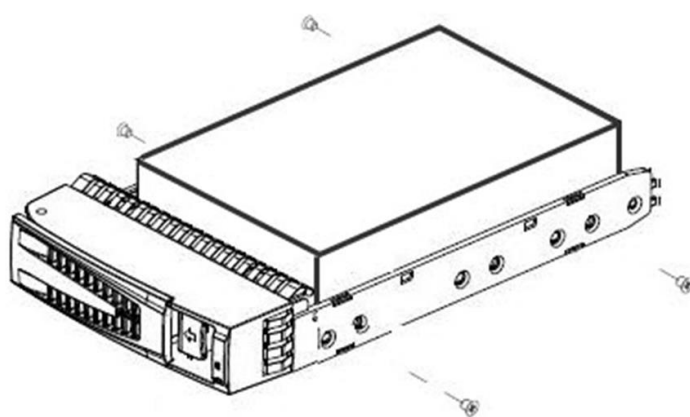

Figure 2-13 Secure HDD

Step 5 Insert the HDD bracket (with the PCB side towards the left of the chassis) to the chassis and push it along the guide apparatus to the bottom. Then, press the securing handle to ensure the bracket has been seated into position and lock it.

Step 6 Repeat the operating steps above till all HDDs have been installed.

### Indicators in Dummy HDD

- Two indicators are provided.
- When the HDD is normal, the blue indicator is on.
- When the HDD is unavailable, the red indicator is on.
- When the HDD is in positioning or detecting status, the red indicator flashes.



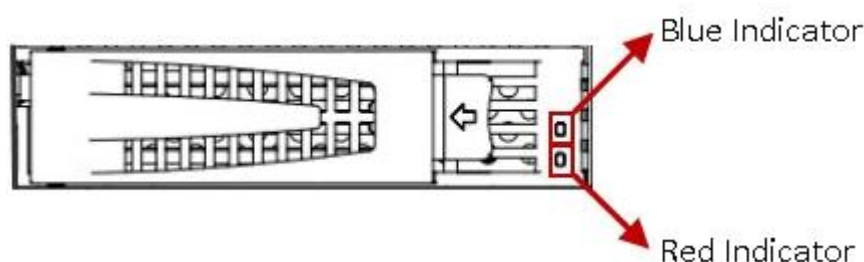

Figure 2-14 Indicators in Dummy HDD

## Precautions during HDD Installation

When you plug or unplug the hard disks, please take the following precautions:

- When the HDD is running, the maximum vibration it can suffer is 0.25 Gs. While when it is idle, the maximum vibration is 3.0 Gs.
- Please use the provided screws to fix the four edges of the dummy HDD.
- Make sure the HDD mounting bracket is steadily plugged into the chassis along the slot.
- When you unplug the hard disk, unplug it about 3cm away from the chassis and then make it stay about 30 seconds on the slot guide before totally unplugging it from the chassis. Since the discs of the hard disk are still spinning at a high speed just after powering off, unplugging the hard disk immediately will damage the discs.
- The system supports HDD hot swapping, yet the data storage safety is not ensured.
- Please avoid frequent plugging/unplugging of the hard disks during the system running so as to maintain long service life of the hard disks.
- Take regular check and examine of the working status of the hard disks every two months, or configure the system with auto check and examine task.

### NOTE

Please avoid unplugging a hard disk when it is writing or reading data so as to prevent data loss.

## 2.3 Startup

Obey the following rules to operate startup and shutdown:

Step 1 Connect all the power cords to the redundancy power supply module before applying power.

Step 2 Press the power button on the device. It may take 5 to 10 minutes to finish the startup process. After startup, storage system will send out beep sound.

 **NOTE**

- Check the connection between components if device cannot start up normally.
- Do not press the power button after startup, or device will be forced to shut down and may cause the data loss.

## 2.4 Shutdown

Step 1 Log in the storage system via Internet Explore. For details, refer to *4.1 Activate Storage System*.

Step 2 Go to **Device > Device Overview**.

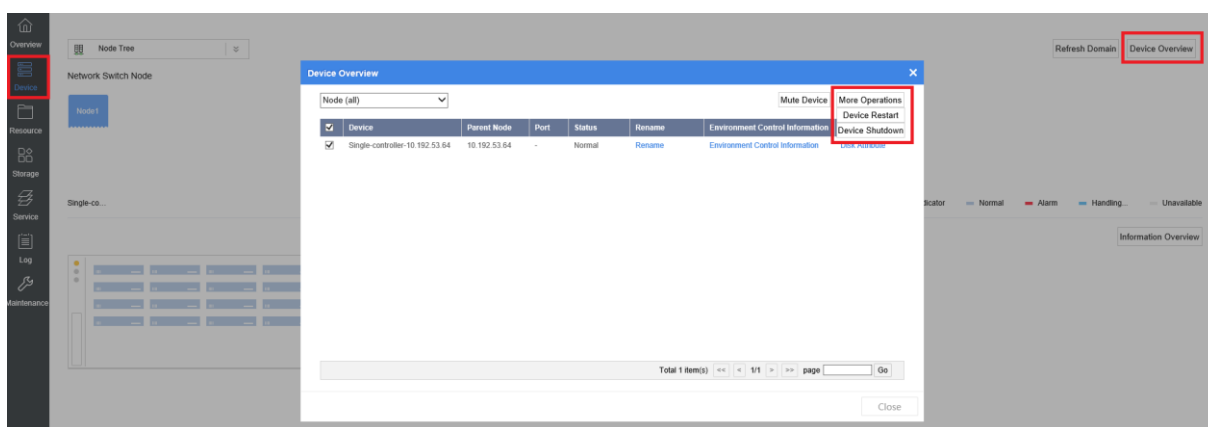

Figure 2-15 More Operations

Step 3 Click **More Operations**.

Step 4 Click **Device Restart** or **Device Shutdown** as your desire.

## Chapter 3 Function Configuration

Step 1 Configure network parameters. For details, refer to *4.2 Configure Network Parameters*.

Step 2 Operate quick configuration. For details, refer to *5.1 One-Key Configuration*.

Step 3 Format storage space. For details, refer to *5.2 Format Storage Space*.

Step 4 Configure Hybrid SAN parameters. For details, refer to *Chapter 6 Basic Configuration*.

## Chapter 4 Network



You are recommended to connect all the network interfaces to the Internet.

### 4.1 Activate Storage System

#### **Purpose**

For the first-time access, you need to activate the storage system by setting an admin password. No operation is allowed before activation. You can only use Internet Explorer 8.0 and above to visit storage system.

Step 1 Use an Ethernet cable to connect your computer and the management network interface of storage system.

Step 2 Set your computer IP address. Ensure it is in the same network segment with the storage system.



Default IP address of management network interface is 10.254.254.254.

Step 3 Visit <https://10.254.254.254:2004> in web browser to access the storage system.

Step 4 Create password for storage system and confirm it.



---

**STRONG PASSWORD RECOMMENDED**– We highly recommend you create a strong password of your own choosing (using a minimum of 8 characters, including upper case letters, lower case letters, numbers, and special characters) in order to increase the security of your product. And we recommend you reset your password regularly, especially in the high security system, resetting the password monthly or weekly can better protect your product.

---

Step 5 Click **Enter** to activate the storage system.

### 4.2 Configure Network Parameters

#### 4.2.1 Modify Network Parameters

Step 1 Go to **Device > Information > Modify Network**.

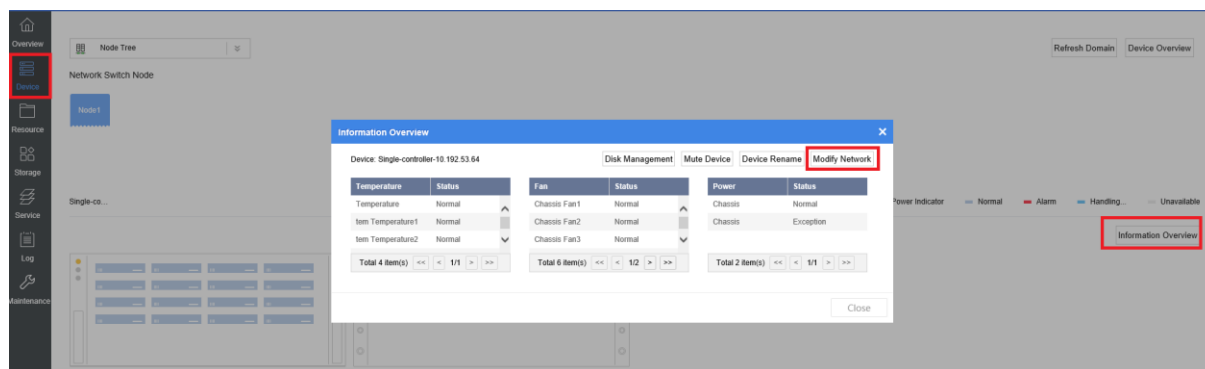

Figure 4-1 Modify Network

Step 2 You can view binding network information and modify binding parameters.

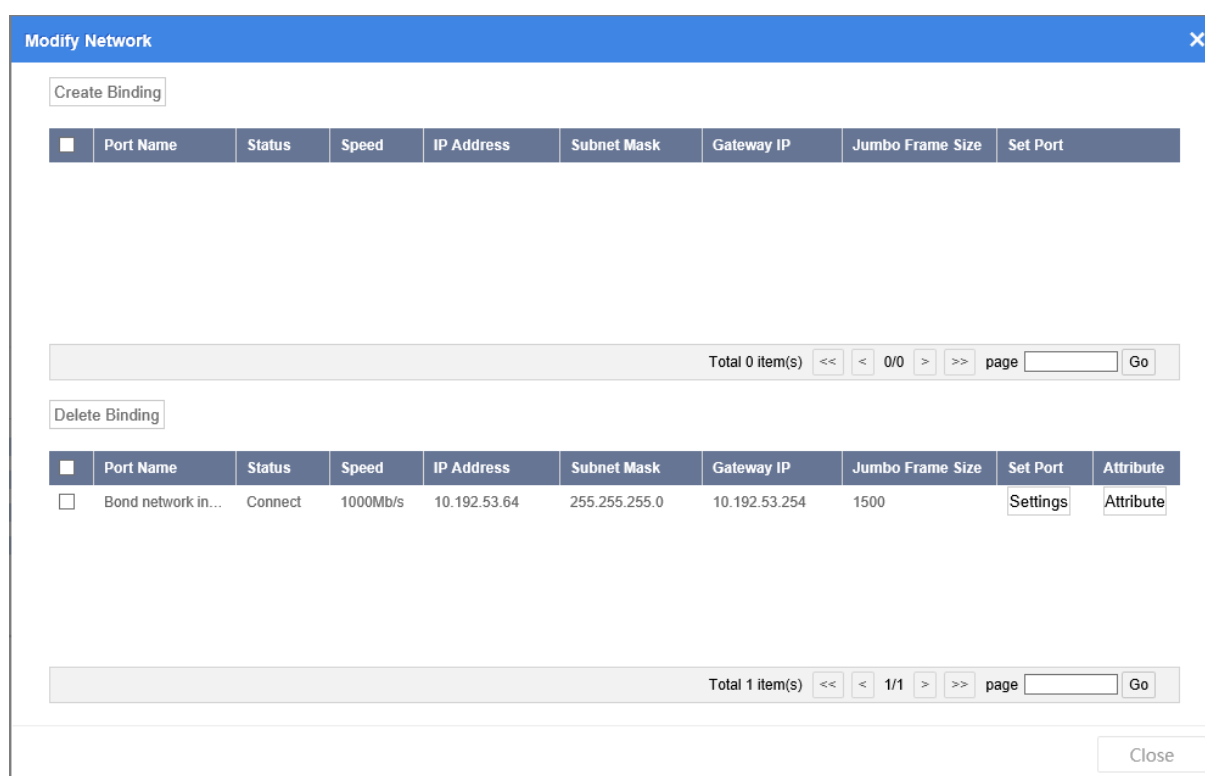

Figure 4-2 Modify Network

**NOTE**

- DS-AT1000S/360, DS-AT1000S/440, and DS-AT1000S/480 series storage system contains 5 network interfaces. By default, network interface 1 and 4 are bonded as a data network interface (bond network interface 1) and bonding mode is XOR.
- DS-AT1000S/160, DS-AT1000S/240, DS-AT1000S/300, and DS-AT1000S/320 series storage system contains 4 network interfaces. By default, network interface 1 and 3 are bonded as a data network interface (bond network interface 1) and bonding mode is XOR. Network interface 4 is management network interface.
- Configure static link aggregation and disable LACP for the network switch

- You are not recommended to delete the default binding.
- If you forget the IP address of data network interface, you can log in storage system via management network interface to view the IP address. Default IP address of management network interface is 10.254.254.254.

## 4.2.2 Modify IP Address of Bond Network Interface

Step 1 Go to **Device > Information > Modify Network**.

Step 2 Click **Settings** of bond network interface 1.

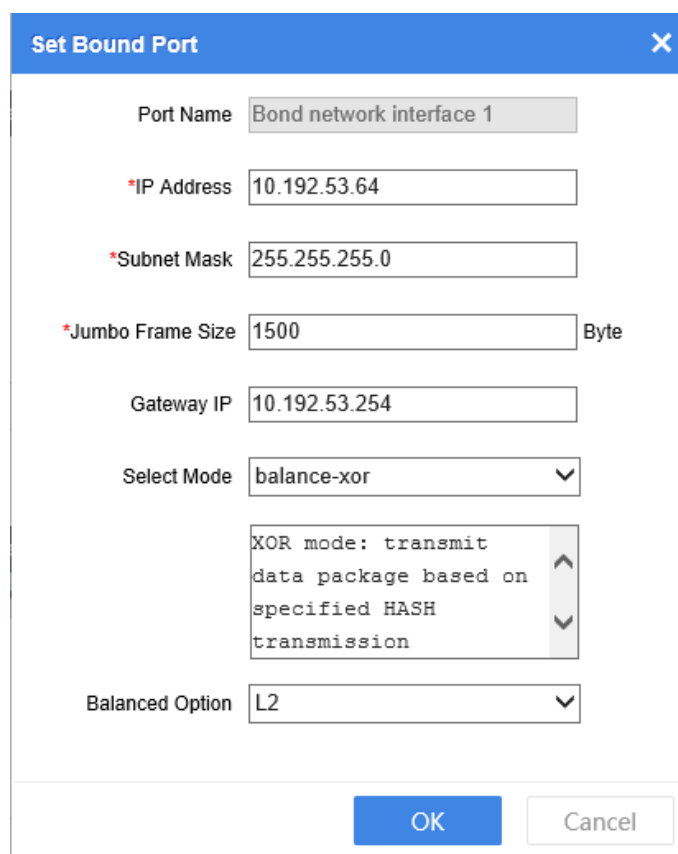

**Set Bound Port**

Port Name: Bond network interface 1

\*IP Address: 10.192.53.64

\*Subnet Mask: 255.255.255.0

\*Jumbo Frame Size: 1500 Byte

Gateway IP: 10.192.53.254

Select Mode: balance-xor

XOR mode: transmit data package based on specified HASH transmission

Balanced Option: L2

OK Cancel

Figure 4-3 Set Bound Port

Step 3 Modify network parameters.

Step 4 Click **OK**.

### NOTE

- Connect all the bonded network interfaces to a network switch.
- Management network interface cannot be bonded.

## Chapter 5 System Configuration

### 5.1 One-Key Configuration

Before you start one-key configuration, ensure the number of HDD meets the following requirement.

- DS-AT1000S/160 storage system requires at least 8 HDDs.
- DS-AT1000S/240 storage system requires at least 12 HDDs.
- DS-AT1000S/300 storage system requires at least 15 HDDs.
- DS-AT1000S/320 storage system requires at least 16 HDDs.
- DS-AT1000S/360 storage system requires at least 18 HDDs.
- DS-AT1000S/440 storage system requires at least 22 HDDs.
- DS-AT1000S/480 storage system requires at least 24 HDDs.

Step 1 Single controller device will automatically create domain after startup.

Domain IP address: 1.1.1.1. Domain subnet mask: 255.255.255.0.

Step 2 After logged into the system, the configuration wizard will pop up and the system will automatically detect environment.

Step 3 After the three environment detections are passed, click **One-Key Configuration** and follow the wizard to configure the system.

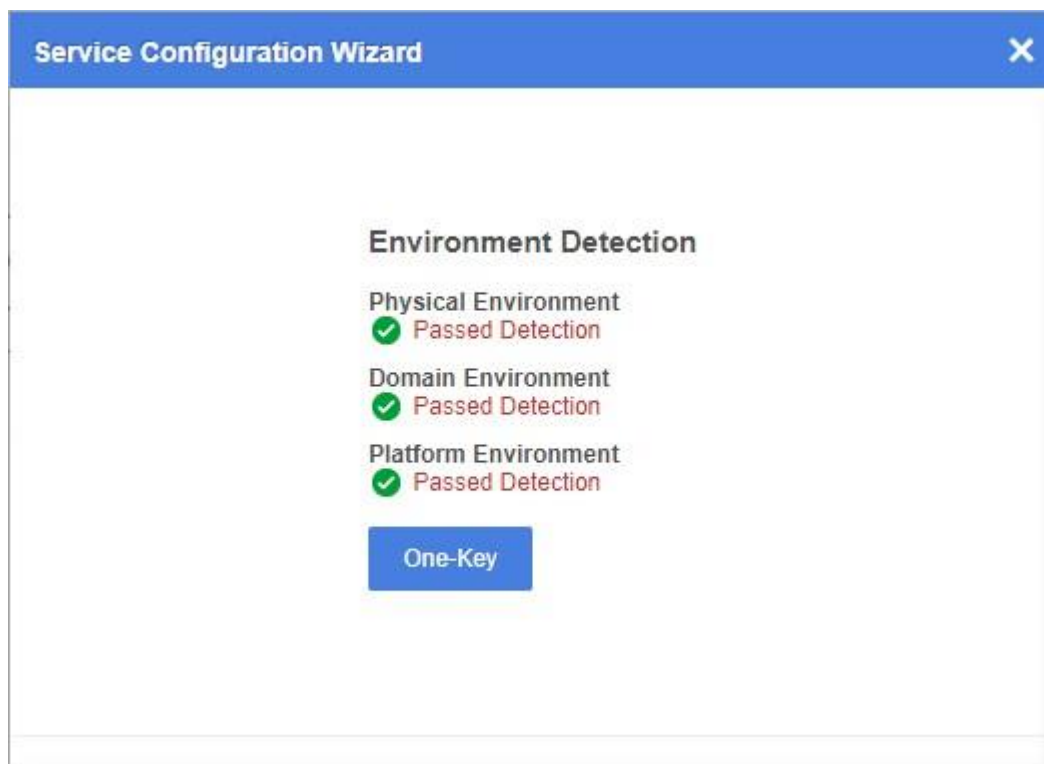

Figure 5-1 Wizard

The configuration process takes a certain time. The following prompt will pop up after configuration finishes.



Figure 5-2 Prompt

## 5.2 Format Storage Space

### 5.2.1 Activate Hybrid SAN Sub-System

#### **Purpose**

You can only use Internet Explorer 8.0 and above to visit Hybrid SAN sub-system.

Step 1 Visit <http://IP address of bond network interface 1> in web browser to access Hybrid SAN sub-system.

Step 2 Create password for Hybrid SAN sub-system and confirm it.





**WARNING**

**STRONG PASSWORD RECOMMENDED**– We highly recommend you create a strong password of your own choosing (using a minimum of 8 characters, including upper case letters, lower case letters, numbers, and special characters) in order to increase the security of your product. And we recommend you reset your password regularly, especially in the high security system, resetting the password monthly or weekly can better protect your product.

Step 3 Click **Enter** to activate Hybrid SAN sub-system.

## 5.2.2 Format Storage Space

Step 1 Go to **Configuration > Storage > Storage Management**.

Storage Space Management										
Storage Pool	Capacity	Free space	Status	Type	Property	Video Occupa...	Image Occupa...	File Occupanc...	Progress	
<input type="checkbox"/>	3	60507.50GB	0.00GB	Error	Local	R/W	100	0	0	
<input type="checkbox"/>	4	60507.50GB	0.00GB	Error	Local	R/W	100	0	0	
<input type="checkbox"/>	5	60507.50GB	0.00GB	Error	Local	R/W	100	0	0	

Figure 5-3 Storage Space Management

Step 2 Select storage space and click **Format**.

## Chapter 6 Basic Configuration

Log in to Hybrid SAN sub-system and follow the steps to configure basic parameters.

### 6.1 Camera Management

Step 1 Log in to Hybrid SAN sub-system. For details, refer to *5.2.1 Activate Hybrid SAN Sub-System*.

Step 2 Go to **Configuration > System > Camera Management**.

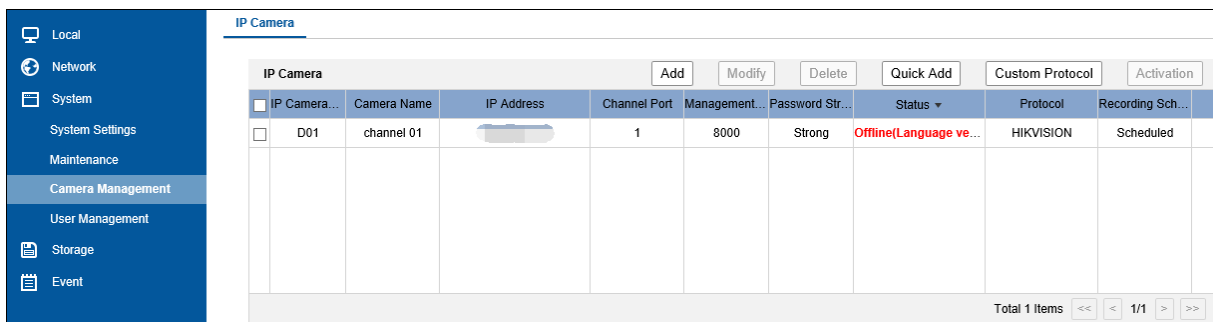

IP Camera...	Camera Name	IP Address	Channel Port	Management...	Password Str...	Status	Protocol	Recording Sch...
<input type="checkbox"/>	D01	channel 01	1	8000	Strong	Offline(Language ve...	HIKVISION	Scheduled

Total 1 Items << < 1/1 > >>

Figure 6-1 Camera Management

Step 3 Add network cameras. Choose from:

- Manual Add: Enter the network camera information to add it.
  - 1) Click **Add**.

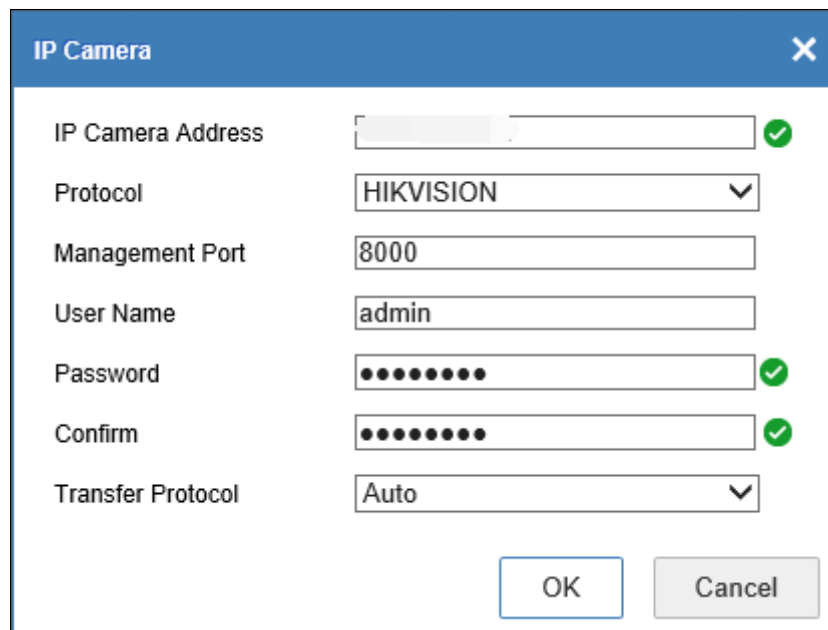

**IP Camera** [X]

IP Camera Address: [ ] ✓

Protocol: HIKVISION [v]

Management Port: 8000 [ ]

User Name: admin [ ]

Password: [ ] ✓

Confirm: [ ] ✓

Transfer Protocol: Auto [v]

OK Cancel

Figure 6-2 Add Network Camera

- 2) Enter network camera information. The information must be the same with the information of network camera to add.
  - 3) Click **OK**.
- Quick Add: Add network cameras of the same password and in the same network segment the storage system.
    - 1) Click **Quick Add**. Network cameras in the same network segment with the storage system will be listed.
    - 2) Check network cameras to add and click **OK**. Network cameras of the same password with the storage system will be successfully added.

## 6.2 Configure Recording Schedule

### Purpose

By default, network cameras start continuous recording after successfully added. Follow the steps to configure recording schedules.

Step 1 Log in to Hybrid SAN sub-system. For details, refer to *5.2.1 Activate Hybrid SAN Sub-System*.

Step 2 Go to **Configuration > Storage > Schedule Settings**.

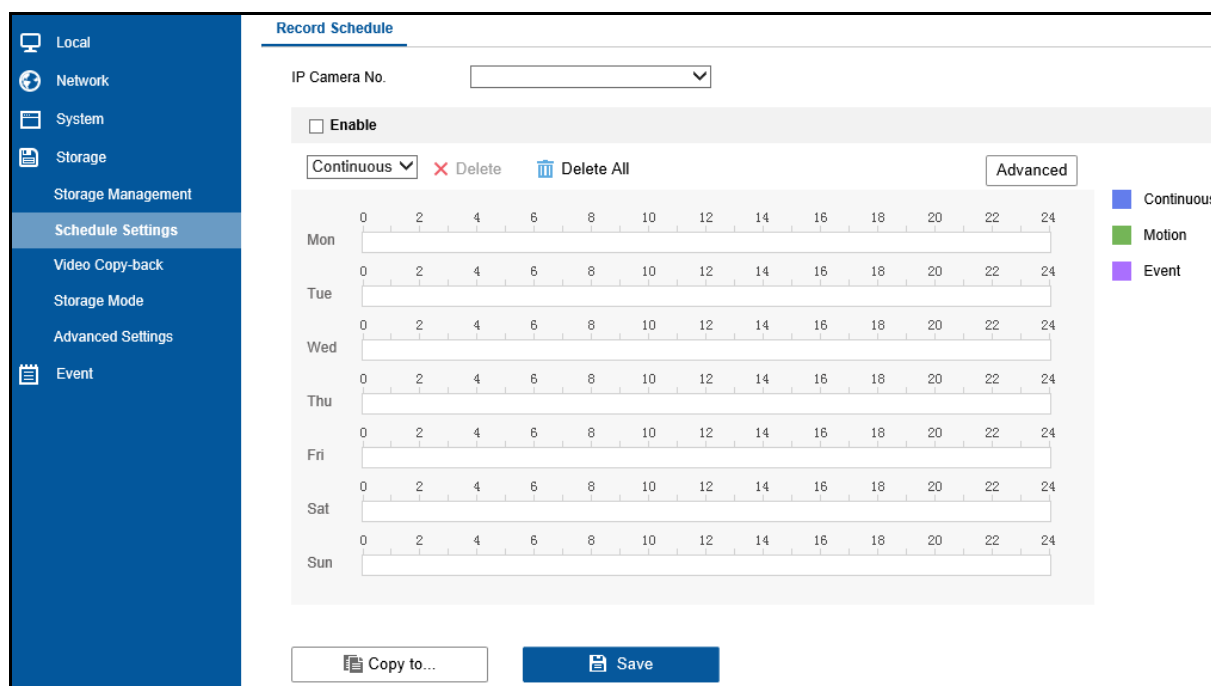

Figure 6-3 Record Schedule

Step 3 Select **IP Camera No.** and check **Enable**.

Step 4 Select schedule type.

Step 5 Drag on the table to draw the recording schedule.

Step 6 Click **Save**.

## 6.3 Live View

Go to **Live View**. You can preview live images, start manual recording, capture pictures, turn on live view audio, etc.

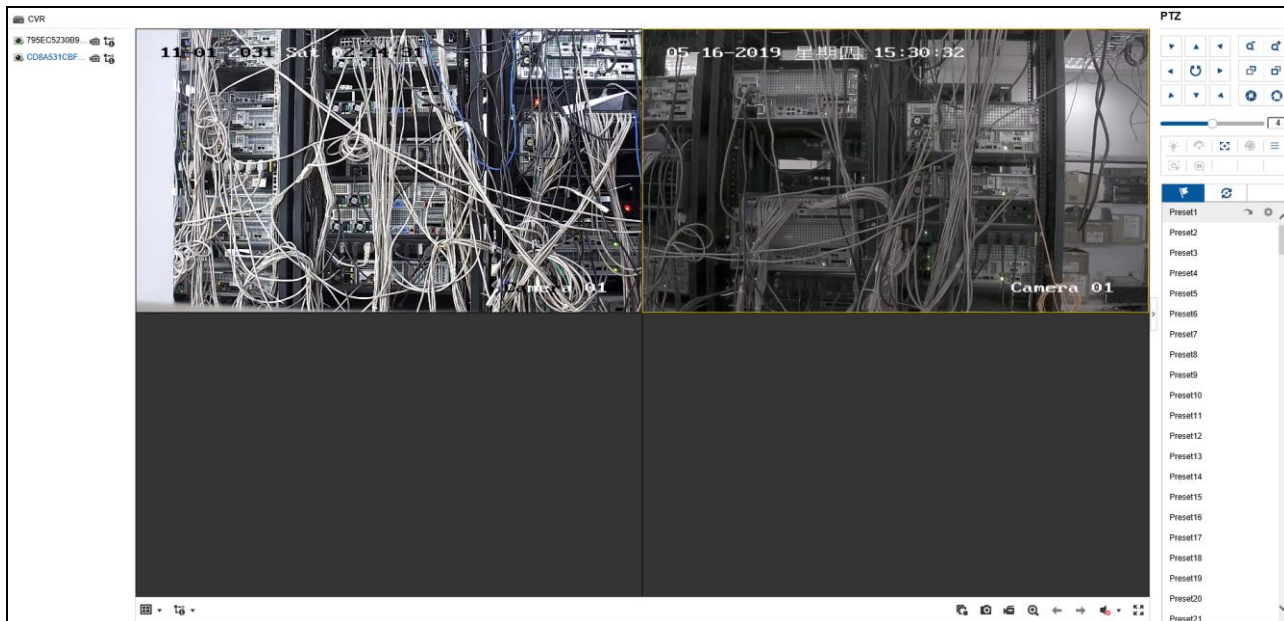

Figure 6-4 Live View

## 6.4 Playback

Go to **Playback**. You can play back, search, download recorded videos.

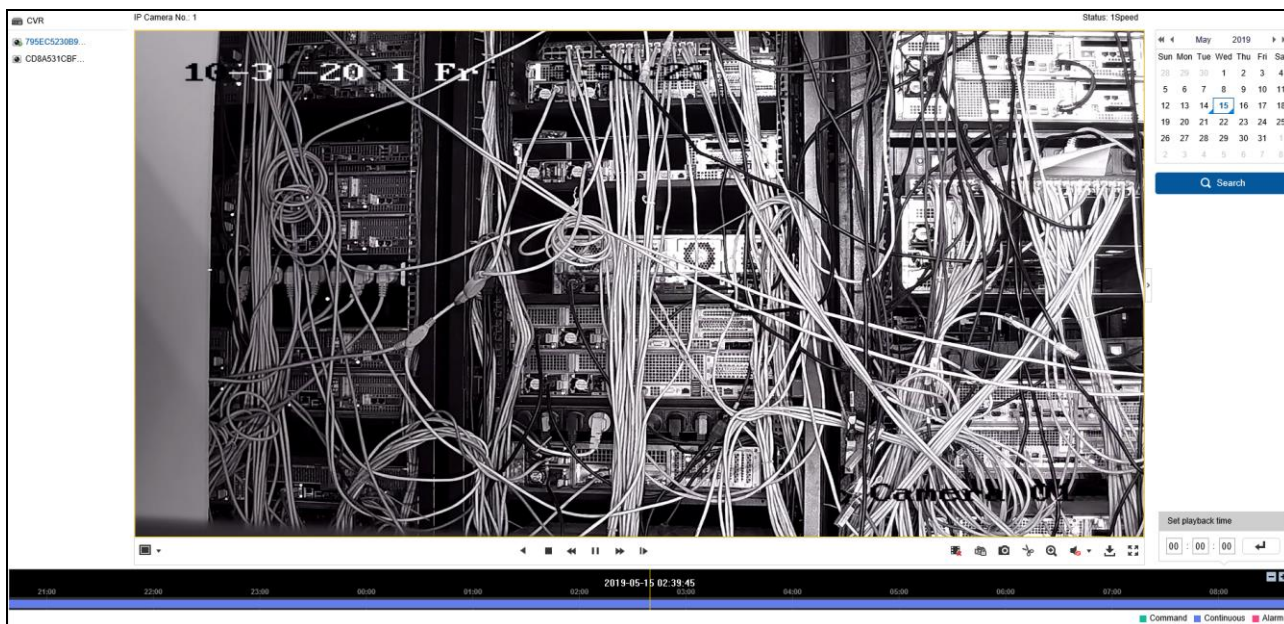

Figure 6-5 Playback



See Far, Go Further

UD28605B