

CyberPower®

Reliability. Quality. Value.

User Manual

Automatic Transfer Switch

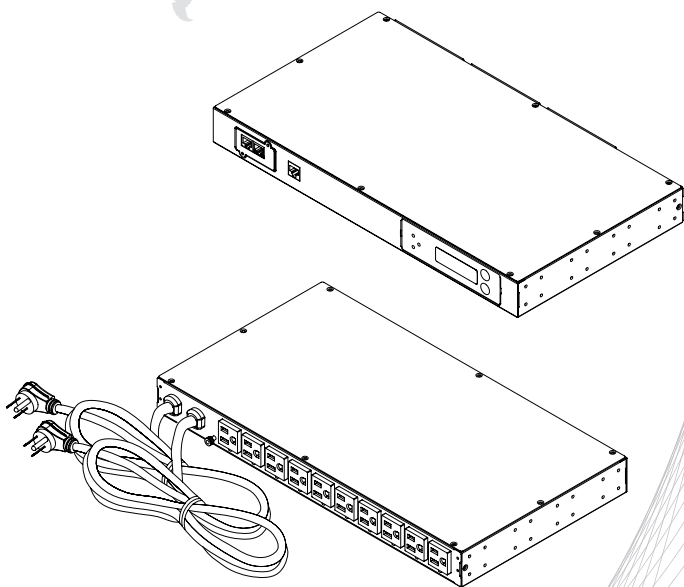

Table of Contents

Overview	1
Model List	1
Product Contents	2
For 1U Series.....	2
For 2U Series.....	3
Product Features	4
Front/Rear Panel Description (1U 15A series).....	4
Technical Specifications.....	4
Front/Rear Panel Description (1U 20A series).....	5
Technical Specifications.....	5
Front/Rear Panel Description (2U series).....	6
Technical Specifications.....	6
Installation Guide	7
For 1U Series.....	7
For 2U Series.....	8
Replace LCD Panel.....	9
Electrical Installation.....	9
Network Installation.....	10
(performed when Remote Management Card is available).....	10
Power Cord Retention Clip Installation- For IEC type ATS ...	11
Input Power Cord Retention Cable Clip Installation.....	11
Power Cord Retention Clip Installation.....	12
Remove the Power Cord Retention Clip.....	13
Operation	13
Remote Management.....	13
Web.....	13
Telnet and SSH.....	13
SNMP.....	13
Local Management.....	14
LCD Operation.....	14
LED Indicators.....	14
Environmental Monitoring (optional).....	14
Device Reset.....	15
Unattended/Automatic Shutdown.....	15
Firmware Upgrade	15
ATS and LCD.....	15
RMCARD.....	18
Troubleshooting	19
Conformance Approvals	19
Customer Service & Warranty	20
Appendix A-Hyper Terminal	22
Appendix B-Power Device Network Utility	23

Overview

CyberPower Automatic Transfer Switches equip with dual sources that can provide redundant and more reliable power to critical devices with single input. Users can define Source A or B as preferred power supply. When selected source is unstable or unavailable, ATS will switch to another source to constantly provide power to connected devices. The entire ATS series are designed with LED plus LCD interfaces so that users can easily observe power status and device load. On-site power management is accomplished as users can configure power settings via LCD interface according to local power condition. Offered with both switched and metered/monitored type ATS, therefore, users can choose the most suitable one based on their needs.

Model List

Switched Series	Metered/Monitored Series
1U	1U
PDU15SW10ATNET	PDU15M10AT
PDU20SW10ATNET	PDU20M10AT
PDU20SWT10ATNET	PDU20MT10AT
PDU20SWHV10ATNET	PDU20MHVT10AT
PDU15SWHVIEC12ATNET	PDU15MHVIEC12AT
PDU20SWHVIEC10ATNET	PDU20MHVIEC10AT
PDU20SWHVCEE10ATNET	PDU20MHVCEE10AT
2U	2U
PDU30SWT17ATNET	PDU30MT17AT
PDU30SWHV19ATNET	PDU30MHVT19AT

Safety Precautions

Read the following before installing or operating the Automatic Transfer Switches (ATS):

- Use only the supplied hardware to attach the mounting brackets.
- The ATS must be plugged into a single phase three-wire, grounded outlet on a circuit that is protected by a fuse or circuit breaker. For PDU15xxxx series, please use 15A circuit protector. For PDU20xxxx series, please use 20A circuit protector. For PDU30xxxx series, please use 30A circuit protector. Connection to any other type of power outlet may result in a shock hazard.
- Do not use extension cords or adapters with this ATS.
- Never install an ATS or associated wiring or equipment during a lightning storm.
- Ensure that the power cord, plug, and socket are in good condition.



To prevent the risk of fire or electric shock, this ATS should be installed in a temperature and humidity controlled indoor area free of conductive contaminants. Do not install this ATS where excessive moisture or heat is present.



Check

Before using, please check to ensure the package contains all the items shown below. If there are missing parts, please contact your local CyberPower sales team for technical support.

Product Contents

For 1U Series

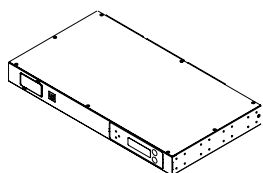

ATS



2 (M3x4) Cord Retention Tray Mounting Screws

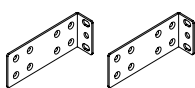

Mounting Bracket x 2

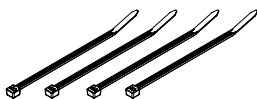

Cable Ties: Qty. 18 for 10 outlets, 21 for 12 outlets



24 (M4x8) Bracket Mounting Screws (Include eight spares)

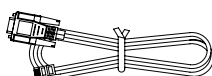

RJ45/DB9 Serial Port Connection Cable



6 (M5x12) Rack Mounting Screws/
6 Washers (Include two spares for each)



Jumper (Switched type only)

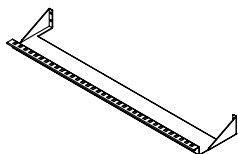

Cord Retention Tray



User Manual / Registration Card / CD

Below items only provided with IEC type ATS

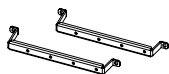

IEC Socket Power Cord Stand (2 for 10 outlets, 3 for 12 outlets)



Power Cord Retention Cable Clip (18 for 10 outlets, 21 for 12 outlets)



(M3x4) Screws (15 for 10 outlets, 22 for 12 outlets)



Cable Tie (18 for 10 outlets, 21 for 12 outlets)

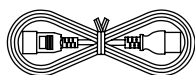

Power Cord 10 feet
IEC-320 C13/C14 x 2
(PDU15SWHVIEC12ATNET/
PDU15MHVIEC12AT Model Only)

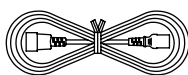

Power Cord 10 feet
IEC-320 C19/C20 x 2
(PDU20SWHVIEC10ATNET/
PDU20MHVIEC10AT Model Only)

Product Contents

For 2U Series

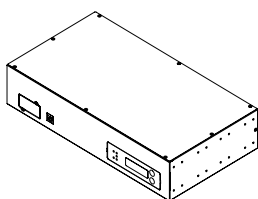

ATS



4 (M3x4) Cord Retention Tray Mounting Screws

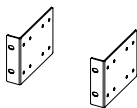

Mounting Bracket x 2

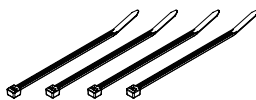

Cable Ties: Qty. 30



24 (M4x8) Bracket Mounting Screws
(Include eight spares)

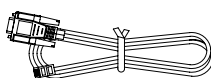

RJ45/DB9 Serial Port Connection Cable



6 (M5x12) Rack Mounting Screws/
6 Washers (Include two spares for each)



Jumper (Switched type only)

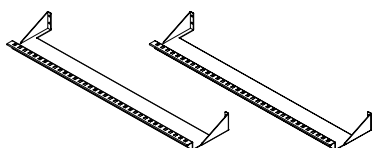

Cord Retention Tray X 2



User Manual / Registration Card / CD

Below items only provided with IEC type ATS

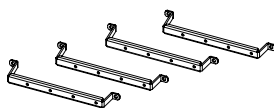

IEC Socket Power Cord Stand x 4



Power Cord Retention Cable Clip x 27

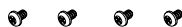

29 (M3x4) Screws



Cable Tie x 27

Product Features

Front/Rear Panel Description (1U 15A series)



NEMA Type

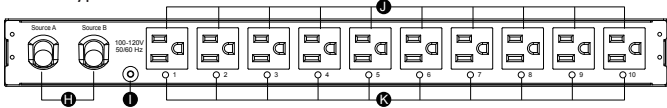

IEC Type

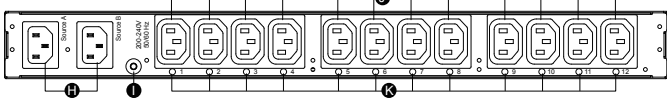

- A. SNMP/HTTP Network Slot
Allow users to remotely control and monitor ATS when installed with CyberPower's Remote Management Card.
- B. Serial Port (RJ45 modular port)
Use serial port to connect with PC and execute local control of ATS.
- C. Source Indicator
Indicate Source A or B is in use. When both sources are normal, selected source shows constant green LED while another source shows blinking green LED.
- D. Output Indicator
Indicate load condition of the ATS.
- E. Multifunction LCD Readout
Display various ATS information such as power and load condition.
- F. Select Button
Use to select among a variety of information the LCD can display.
- G. Enter Button
Use to choose selected item, enter to next level menu or return to previous menu.
- H. AC Inlet/AC Power Cord
Use to connect ATS to utility power or UPS.
- I. Ground Stud
Use to ground the ATS.
- J. AC Output Outlets
Provide connected equipment continuous power supply.
- K. Outlet Indicator (switched series only)
When the LED is on, the outlet can provide power to connected equipment.

Technical Specifications

	Switched Series		Metered Series	
Model Name	PDU15SW10ATNET	PDU15SWHVIEC12ATNET	PDU15M10AT	PDU15MHVIEC12AT
Input				
Nominal Voltage	100-120V	200-240V	100-120V	200-240V
Frequency	50/60Hz			
Derated Input Current	12A	12A(UL)/10A(CE)	12A	12A(UL)/10A(CE)
Plug Type	(2) NEMA 5-15P	(2) IEC-320 C14	(2) NEMA 5-15P	(2) IEC-320 C14
Power Cord Type	SR (14 AWG)	Socket	SR (14 AWG)	Socket
Power Cord Length	10 ft/3.05 m			
Output				
Nominal Voltage	100-120V	200-240V	100-120V	200-240V
Derated Output Current	12A	12A(UL)/10A(CE)	12A	12A(UL)/10A(CE)
Outlet Type	NEMA 5-15R	IEC-320 C13	NEMA 5-15R	IEC-320 C13
Outlet Number	10	12	10	12
Transfer Time	Typical: 8-12ms 16ms max @ 60Hz/ 18ms max @ 50Hz			
Management and Communications				
Multifunction LCD Readout	Voltage, Frequency, Load, Current, HW/FW Version, Network Information			
Software	PowerPanel® Business Edition			
SNMP/ HTTP Capable	Yes, with RMCARD203		Yes, with optional RMCARD202/203	
Connectivity	RJ45 (Serial Port)			
Sensor Capable	Optional			
Physical				
Dimension (W x H x D)	17.05" x 1.75" x 9.3"/433mm x 44mm x 236mm			
Environmental				
Humidity	0 to 95% Non-condensing			
Altitude	13100 ft/4000 m			
Temperature	32°F to 113°F/0°C to 45°C			
Safety Approvals				
Certifications	UL 60950-1 FCC Class A	UL 60950-1 CE, FCC Class A	UL 60950-1 FCC Class A	UL 60950-1 CE, FCC Class A

* All specifications are subject to change without notice.

Product Features

Front/Rear Panel Description (1U 20A series)

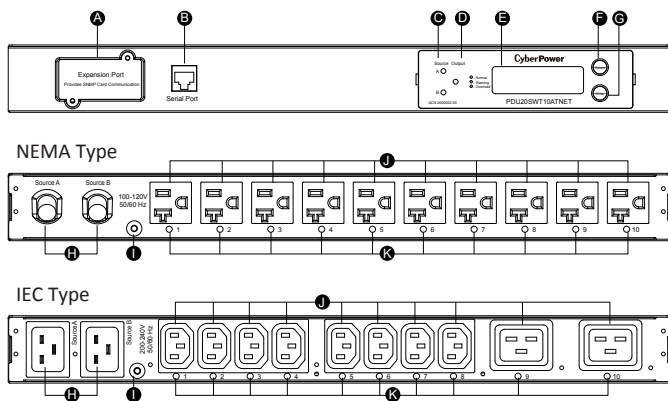

- A. SNMP/HTTP Network Slot
Allow users to remotely control and monitor ATS when installed with CyberPower's Remote Management Card.
- B. Serial Port (RJ45 modular port)
Use serial port to connect with PC and execute local control of ATS.
- C. Source Indicator
Indicate Source A or B is in use. When both sources are normal, selected source shows constant green LED while another source shows blinking green LED.
- D. Output Indicator
Indicate load condition of the ATS.
- E. Multifunction LCD Readout
Display various ATS information such as power and load condition.
- F. Select Button
Use to select among a variety of information the LCD can display.
- G. Enter Button
Use to choose selected item, enter to next level menu or return to previous menu.
- H. AC Inlet/AC Power Cord
Use to connect ATS to utility power or UPS.
- I. Ground Stud
Use to ground the ATS.
- J. AC Output Outlets
Provide connected equipment continuous power supply.
- K. Outlet Indicator (switched series only)
When the LED is on, the outlet can provide power to connected equipment.

Technical Specifications

Model Name	Switched Series		Metered Series	
	PDU20SW10ATNET PDU20SWT10ATNET	PDU20SWHVT10ATNET PDU20SWHVCEE10ATNET PDU20SWHVIEC10ATNET	PDU20M10AT PDU20MT10AT	PDU20MHVT10AT PDU20MHVCEE10AT PDU20MHVIEC10AT
Input				
Nominal Voltage	100-120V	200-240V	100-120V	200-240V
Frequency	50/60Hz			
Derated Input Current	16A			
Plug Type	(2) NEMA 5-20P (2) NEMA L5-20P	(2) NEMA L6-20P (2) IEC 309 16A (2) IEC-320 C20	(2) NEMA 5-20P (2) NEMA L5-20P	(2) NEMA L6-20P (2) IEC 309 16A (2) IEC-320 C20
Power Cord Type	SR (12AWG)	SR (12AWG) Socket	SR (12 AWG)	SR (12AWG) Socket
Power Cord Length	10 ft/3.05 m			
Output				
Nominal Voltage	100-120V	200-240V	100-120V	200-240V
Derated Output Current	16A	C13: 12A (UL) 10A (CE) C19: 16A	16A	C13: 12A (UL) 10A (CE) C19: 16A
Outlet Type	NEMA 5-20R	(8) IEC C13/ (2) IEC C19	NEMA 5-20R	(8) IEC C13/ (2) IEC C19
Outlet Number	10	8+2	10	8+2
Transfer Time	Typical: 8-12ms 16ms max @ 60Hz/ 18ms max @ 50Hz			
Management and Communications				
Multifunction LCD Readout	Voltage, Frequency, Load, Current, HW/FW Version, Network Information			
Software	PowerPanel® Business Edition			
SNMP/ HTTP Capable	Yes, with RMCARD203		Yes, with optional RMCARD202/203	
Connectivity	RJ45 (Serial Port)			
Sensor Capable	Optional			
Physical				
Dimension (W x H x D)	17.05" x 1.75" x 9.3"/433mm x 44mm x 236mm			
Environmental				
Humidity	0 to 95% Non-condensing			
Altitude	13100 ft/4000 m			
Temperature	32°F to 113°F/0°C to 45°C			
Safety Approvals				
Certifications	UL 60950-1 FCC Class A	UL 60950-1 FCC Class A	UL 60950-1 FCC Class A	UL 60950-1 FCC Class A
		UL 60950-1 CE, FCC Class A		UL 60950-1 CE, FCC Class A

* All specifications are subject to change without notice.

Product Features

Front/Rear Panel Description (2U series)

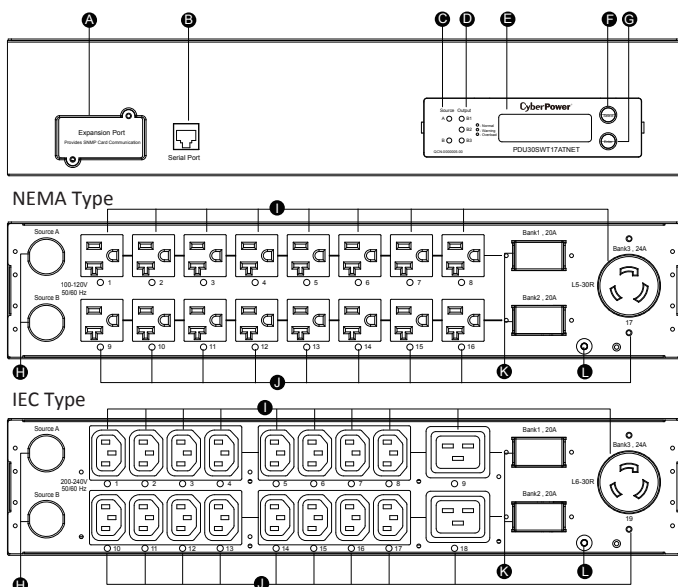

- A. SNMP/HTTP Network Slot
Allow users to remotely control and monitor ATS when installed with CyberPower's Remote Management Card.
- B. Serial Port (RJ45 modular port)
Use serial port to connect with PC and execute local control of ATS.
- C. Source Indicator
Indicate Source A or B is in use. When both sources are normal, selected source shows constant green LED while another source shows blinking green LED.
- D. Output Indicator
Indicate load condition of the ATS.
- E. Multifunction LCD Readout
Display various ATS information such as power and load condition.
- F. Select Button
Use to select among a variety of information the LCD can display.
- G. Enter Button
Use to choose selected item, enter to next level menu or return to previous menu.
- H. AC Inlet/AC Power Cord
Use to connect ATS to utility power or UPS.
- I. AC Output Outlets
Provide connected equipment continuous power supply.
- J. Outlet Indicator (switched series only)
When the LED is on, the outlet can provide power to connected equipment.
- K. Circuit Breaker
Provide output overload protection.
- L. Ground Stud
Use to ground the ATS.

Technical Specifications

	Switched Series		Metered Series	
Model Name	PDU30SWT17ATNET	PDU30SWHVT19ATNET	PDU30MT17AT	PDU30MHVT19AT
Input				
Nominal Voltage	100-120V	200-240V	100-120V	200-240V
Frequency	50/60Hz			
Derated Input Current	24A			
Plug Type	(2) NEMA L5-30P	(2) NEMA L6-30P	(2) NEMA L5-30P	(2) NEMA L6-30P
Power Cord Type	SR (10 AWG)			
Power Cord Length	10 ft/3.05 m			
Output				
Nominal Voltage	100-120V	200-240V	100-120V	200-240V
Derated Output Current	5-20R: 16A L5-30R: 24A	C13: 12A C19: 16A L6-30R: 24A	5-20R: 16A L5-30R: 24A	C13: 12A C19: 16A L6-30R: 24A
Derated Output Current (each bank)	20A			
Bank Number	2			
Outlet Type	(16) NEMA 5-20R (1) NEMA L5-30R	(16) IEC C13 (2) IEC C19 (1) NEMA L6-30R	(16) NEMA 5-20R (1) NEMA L5-30R	(16) IEC C13 (2) IEC C19 (1) NEMA L6-30R
Outlet Number	17	19	17	19
Circuit Breaker	Yes			
Transfer Time	Typical: 8-12ms 16ms max @ 60Hz/ 18ms max @ 50Hz			
Management and Communications				
Multifunction LCD Readout	Voltage, Frequency, Load, Current, HW/FW Version, Network Information			
Software	PowerPanel® Business Edition			
SNMP/ HTTP Capable	Yes, with RMCARD203		Yes, with optional RMCARD202/203	
Connectivity	RJ45 (Serial Port)			
Sensor Capable	Optional			
Physical				
Dimension (W x H x D)	17.05" x 3.5" x 9.3"/433mm x 88mm x 236mm			
Environmental				
Humidity	0 to 95% Non-condensing			
Altitude	13100 ft/4000 m			
Temperature	32°F to 113°F/0°C to 45°C			
Safety Approvals				
Certifications	UL 60950-1, FCC Class A			

* All specifications are subject to change without notice.

Installation Guide



CAUTION!! Please use only the provided screws through the entire installation process.

For 1U Series

Step 1. Mounting Bracket Installation

Use provided Mounting Bracket Screws (16) to attach Mounting Brackets (2) to the ATS.

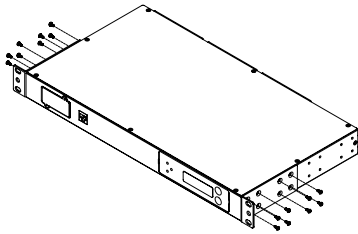

Step 2. ATS Mounting

Use supplied Washers (4) and Screws (4) to secure the ATS to your existing rack system.

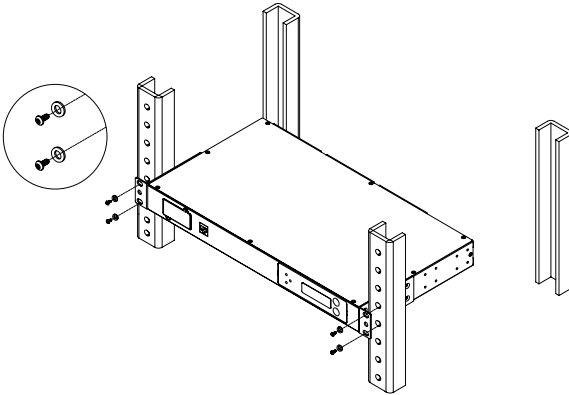

Step 3: Cord Retention Tray Installation (optional)

Attach Cord Retention Tray to the ATS with 4 supplied Cord Retention Tray Mounting Screws.

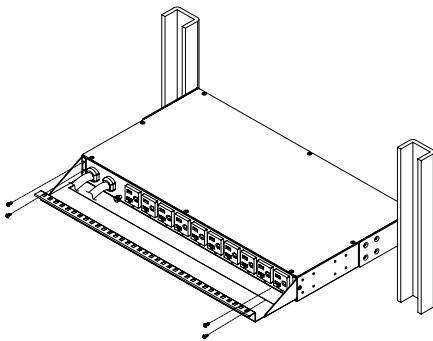

Use provided Cable Ties to fasten each cord to the Cord Retention Tray.

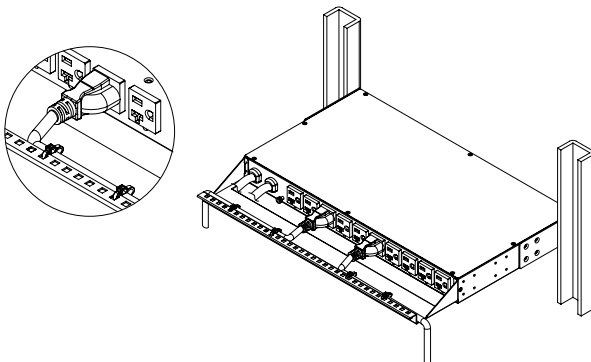

Installation Guide

For 2U Series

Step 1. Mounting Bracket Installation

Use provided Mounting Bracket Screws (16) to attach Mounting Brackets (2) to the ATS.

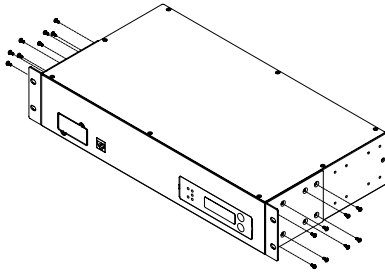

Step 2. ATS Mounting

Use supplied Washers (4) and Screws (4) to secure the ATS to your existing rack system.

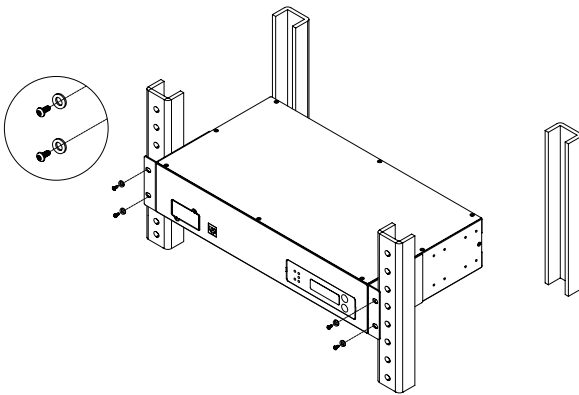

Step 3. Cord Retention Tray Installation (optional)

Attach Cord Retention Tray to the ATS with 8 supplied Cord Retention Tray Mounting Screws.

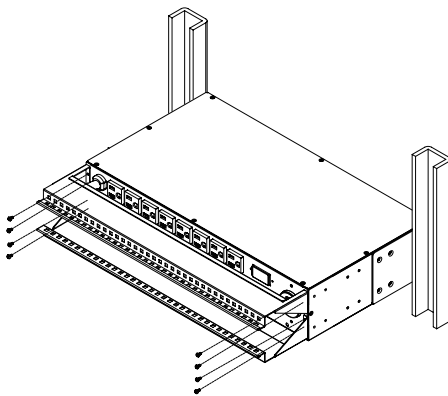

Use provided Cable Ties to fasten each cord to the Cord Retention Tray.

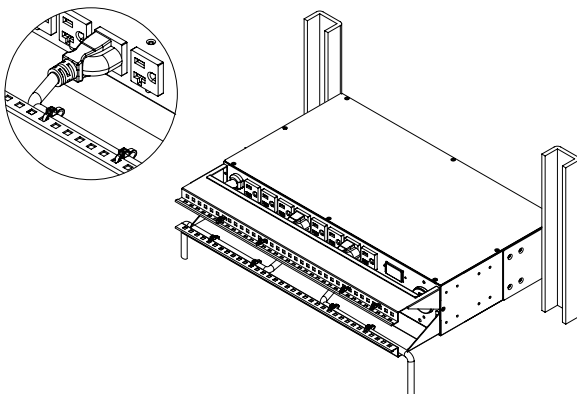

Installation Guide

Replace LCD Panel

Step 1. Use slotted screwdriver to gently lift out the LCD panel.

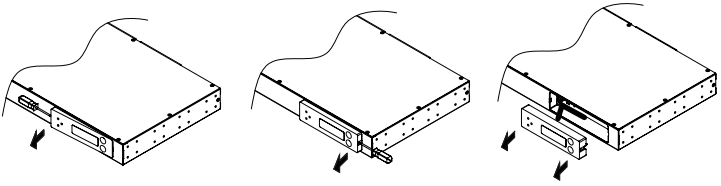

Step 2. Disconnect cable connectors.

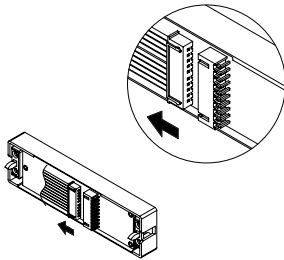

Electrical Installation

Step 1. Receptacle evaluation

Ensure that the plug type of your ATS unit matches the wall receptacle type that you are using.



The ATS must be plugged into a three-wire, grounded wall receptacle only. The wall receptacle must also be connected to an appropriate branch circuit/main with fuse or circuit breaker protection. Connection to any other type of wall receptacle may result in a shock hazard.

Step 2. Plug the ATS into the wall receptacle

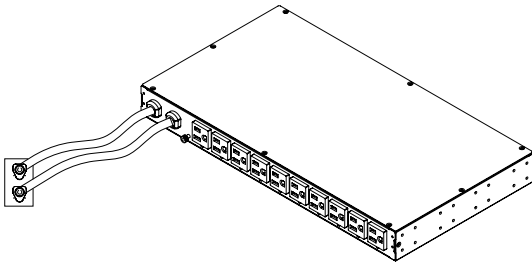

Step 3. Attach equipment

It is extremely important not to exceed the ATS maximum current load (as outlined in the Specifications section). In order to determine total load, simply use the LCD display on the front of the ATS.

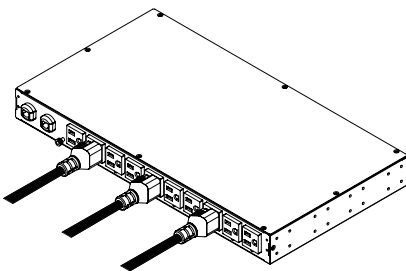

Installation Guide

Power Cord Retention Clip Installation- For IEC type ATS

Input Power Cord Retention Cable Clip Installation

Step 1. Remove screw next to the inlet.

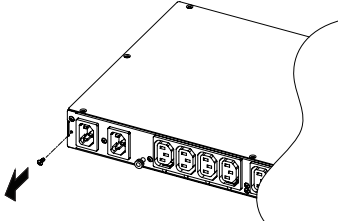

Step 2. Attach Cable Tie on the ATS and secure it with removed screw in the previous step.

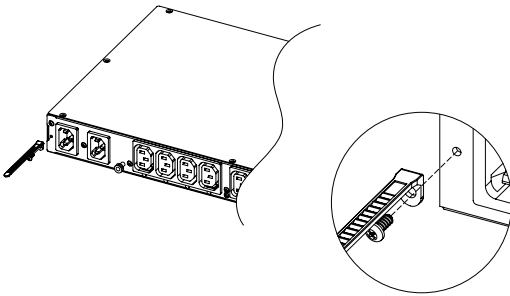

Step 3. Place a Power Cord Retention Cable Clip on the power cord. Align and insert the Cable Tie into the Cable Clip as shown in the figure below.

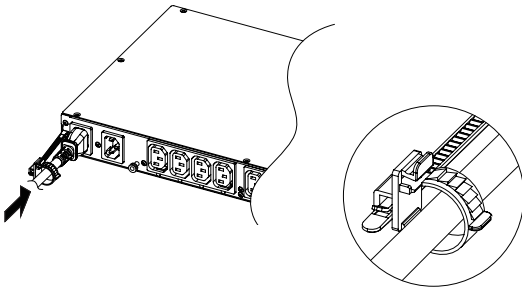

Step 4. Push the Power Cord Retention Cable Clip until it touches the plug and fasten the Retention Cable Clip like the figure below.

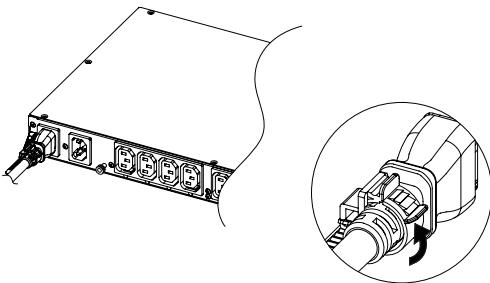

Installation Guide

Power Cord Retention Clip Installation

Step 1. Remove screws next to the outlet where IEC Socket Power Cord Stand will be installed.

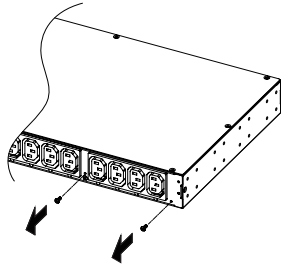

Step 2. Attach IEC Socket Power Cord Stand on the ATS and secure it with removed screws in the previous step.

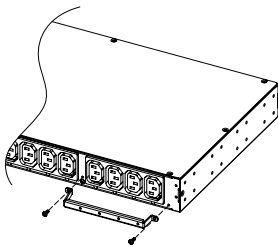

Step 3. Attach Cable Tie on the IEC Socket Power Cord Stand and secure it with provided screw.

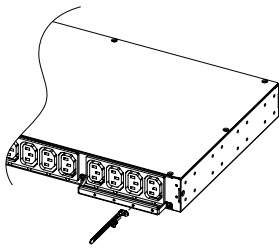

Step 4. Place a Power Cord Retention Cable Clip on the power cord. Align and Insert the Cable Tie into the Cable Clip as shown in the figure below.

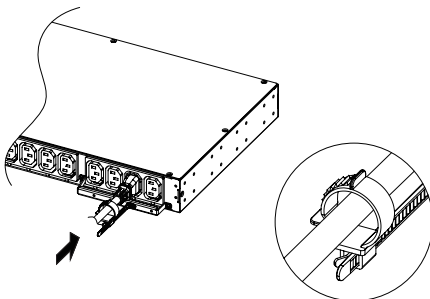

Step 5. Push the Power Cord Retention Cable Clip until it touches the plug and fasten the Retention Cable Clip like the figure below.

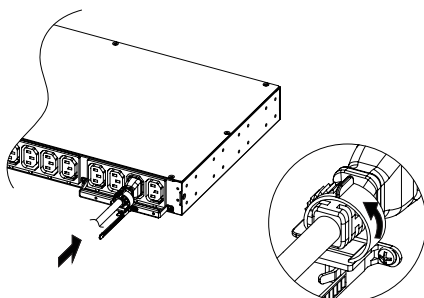

Installation Guide

Remove the Power Cord Retention Clip

Step 1. To remove the Power Cord Retention Clip by pushing it to the right as shown in the figure below.

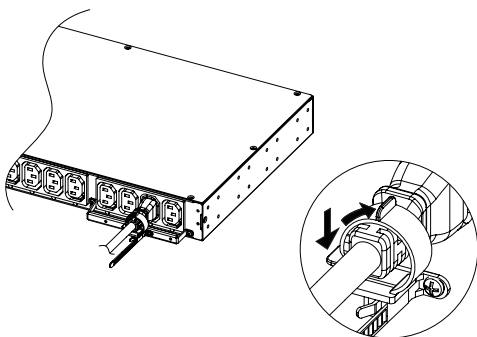

Step 2. Remove the Power Cord Retention Clip by pulling the clip (shown in the image below) to the left.

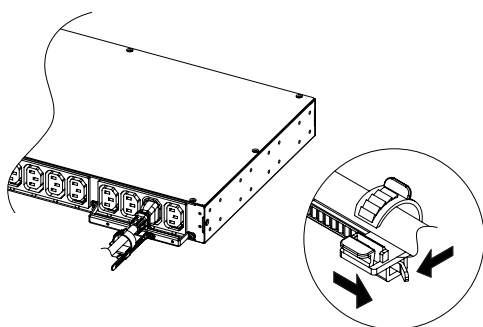

Operation

Remote Management

The remote management function provides for monitoring the ATS vitals, controlling outlets and utilizing SNMP functionality.

Web

Remote management can be performed via web interface. To access the web interface, please follow the instructions below:

1. Enter the IP address of the ATS into a web browser (Internet Explorer, Firefox).
2. Enter the user name and password of the ATS device at the authentication screen.

Note: The default username is “**cyber**” and the default password is “**cyber**”. For additional information about the features and functionality of CyberPower Management Console, please refer to the software Installation CD.

Telnet and SSH

CyberPower ATS provides Telnet and Secure Shell (SSH) as one Remote Management method as well. Telnet uses user name and password as basic security while SSH has higher security level due to encrypting the transmitted packets including user name, password, and data. Configure the Setting of Telnet and SSH on Web Interface, and default user name and password is cyber/cyber.

SNMP

CyberPower ATS provides SNMPv1 and SNMPv3 as one Remote Management method as well. Download the CyberPower’s MIB file and add it to a SNMP-supporting management software. Default read/write community is public/private for SNMPv1. SNMPv3 provides higher security level than SNMPv1 by encrypting the transmitted packet. Configure the Setting of SNMPv1/SNMPv3 on Web Interface .

Operation

Local Management

LCD Operation

The LCD display provides ATS's instant information, such as Source condition, Voltage, Current and so on. In addition, users can use the interface to configure each parameter and control each outlet of the ATS.

A. Scroll Mode: The ATS information will display in following order automatically when "Scroll Mode On" is configured.

Source A information
Source B information
Device Load
Bank 1 Current (2U series)
Bank 2 Current (2U series)
Bank 3 Current (2U series)
Environment Status (Display when ENVIROSENSOR is connected)

B. Main Menu Map

About	Hardware Version
	Firmware Version
	Network Information
	Serial Number

Settings	Preferred Source	A/B/None			
	Source Configuration		Nominal Voltage		
			Voltage Range		
			Freq. Deviation		
			Sensitivity		
	Load Configuration	Device Bank/1/2/3	Overload Threshold		
			Near Overload Threshold		
			Low Load Threshold		
	Outlet Control	Device Bank/1/2/3	All/Outlet 1-N	Immediate On	
				Delay On	
				Immediate Off	
				Delay Off	
				Reboot	
LCD Settings		Brightness			
		Scroll Mode			
		Screen Off			

LED Indicators

Indicator	Status	Description
Source	Solid Green	Selected source and power condition is normal.
	Flashing Green	Bankup source and power condition is normal.
	Orange	Power condition is abnormal.
Load	Green	The aggregate current of each bank is normal.
	Orange	Near overload.
	Red	Overload.
Tx/Rx	Off	The ATS power is off.
	On (Green)	The ATS power is on.
	Flashing	Receiving/transmitting data packet.
Reset finished.		
LINK	On	Indicates the ATS is connected to the LAN.
	Off	Indicates the ATS is not connected to the LAN.
Outlet	On	The outlet is on and providing power.
	Off	The outlet is off.

Environmental Monitoring (optional)

CyberPower ATS along with the environment sensor (ENVIROSENSOR) provide the function of temperature and humidity monitoring in a server closet and/or datacenter remotely. To connect ATS with ENVIROSENSOR, use RJ45 Ethernet Cable. Plug one end into the Universal port on the RMCARD and the other end into the RJ45 port on the ENVIROSENSOR (as shown in figures below). When ATS correctly connects to ENVIROSENSOR, users can see the temperature and humidity data on the Web Interface. For further information regarding ENVIROSENSOR configuration please refer to the Software Installation CD.

Operation

Device Reset

- To reset all the settings to default locally, use Reset item in the LCD display.
- To reset all the settings to default remotely, log in Web interface, enter Reset page and apply the function.

Unattended/Automatic Shutdown

PowerPanel Business Edition software automatically initiates a graceful shutdown on the operating system in an orderly fashion.

PowerPanel must be installed on every PC for which the shut down is to take place. The PC receives SNMP messages directly from the ATS, and these messages can be scheduled for an exact date/time, or can be performed immediately. Follow the directions below for setting up Unattended/Automatic Shutdown.

Step 1. PC Configuration

1. Install PowerPanel Business Edition Client on every PC that will be part of the shut down process (Follow the instructions in the PowerPanel Business Edition Client user manual).
2. Configure the settings in PowerPanel Business Edition Client. See the PowerPanel Business Edition Client User Manual for additional help.

Step 2. ATS Configuration

Verify that the IP address of all PCs that will be part of the shut down process are included in the Client List of web interface (For additional information, please refer to the user manual in the Software Installation CD).

Step 3. Notification

Notifying the PCs of potential outlet shutdown can be accomplished using the following methods:

- Outlets Control Menu: Performing the task of turning off or rebooting outlets
- Scheduling Menu: Setting the scheduler to perform the task of turning off or rebooting outlets. The notification will occur prior to the scheduled date/time.
- Outlet Overload: In the event of ATS overload, notification will be sent prior to the ATS shutting down.

Firmware Upgrade

By upgrading the Firmware, you can obtain new features and updates and improvements to existing functionality.

ATS and LCD

There are two files to update in order to upgrade the firmware:

- cpsatsmaf_w_xxx.bin
- cpsatslaf_w_xxx.bin

Note that the XXX is not part of the file name but is where the version number in the filename is given.

Use the following steps to upgrade the firmware.

1. Download the latest firmware from cpsww.com
2. Extract the file to "C:\"
3. Open Hyper Terminal to connect ATS and use the command "@NEW"

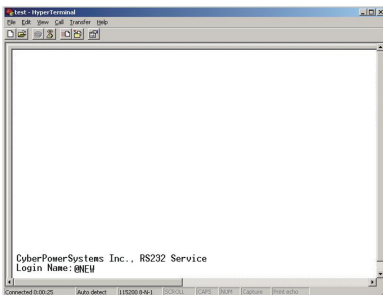

Operation

4. ATS will reboot and show main menu on Hyperterminal.

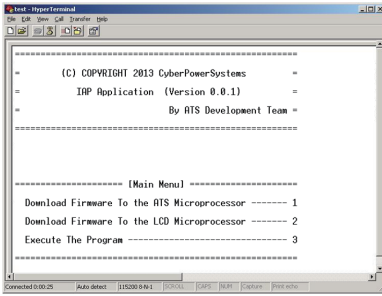

5. Press "1" to select ATS upgrade

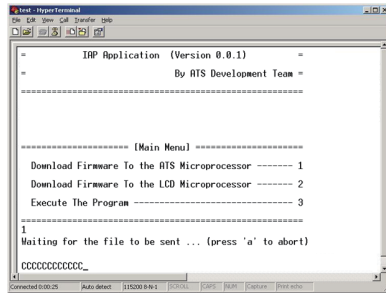

6. Select Transfer > Send File

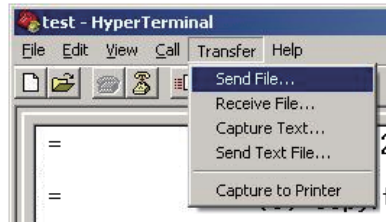

7. Note that the Ymodem protocol and file "C:\cpsatsmaf_w_XXX.bin" are selected in Hyperterminal

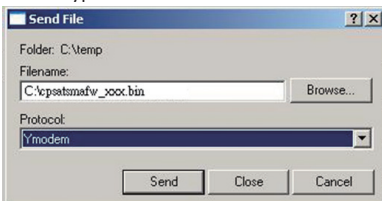

8. Download progress window will open after click Send button

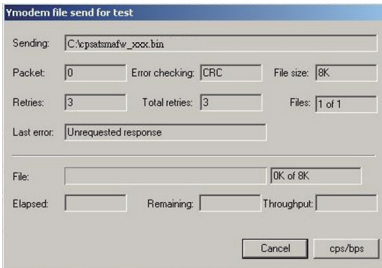

9. After upload binary file Hyperterminal will show as below

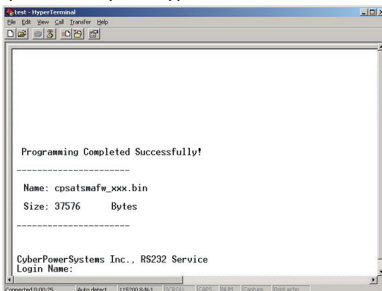

Operation

10. Use the command “@NEW”

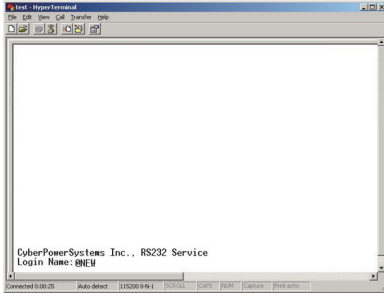

11. ATS will reboot and show main menu on Hyperterminal

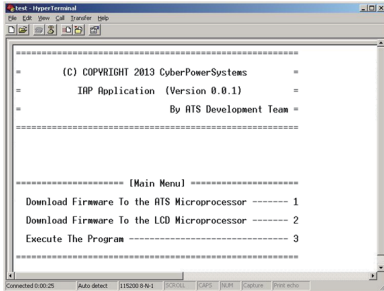

12. Press “2” to select LCD upgrade

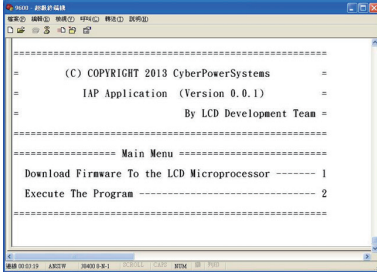

13. Press “1”

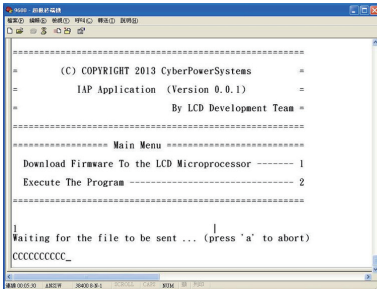

14. Select Transfer > Send File

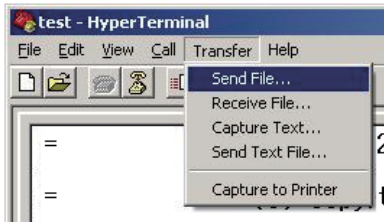

15. Note that the Ymodem protocol and file “C:\cpsatslafw_xxx.bin” are selected in Hyperterminal

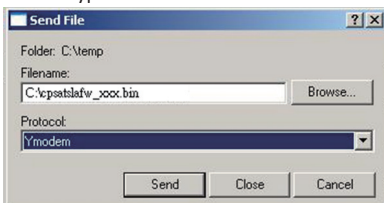

Operation

16. Download progress window will open after click Send button

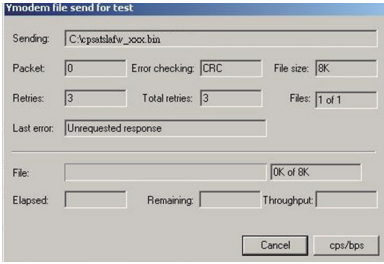

17. After upload binary file Hyperterminal will show as below

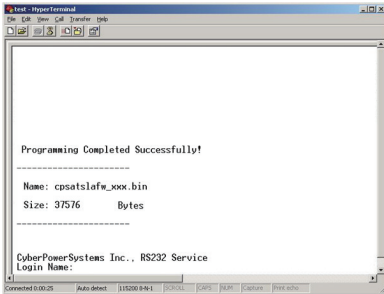

You can check to see if the firmware upgrade is successful by checking the "CyberPower System Firmware Version" after login.

Note :

1. Please do not turn the ATS off and ensure the quality of selected source when processing firmware upgrade. Source will not perform switch function when upgrading firmware.
2. Press "3" to exit the main menu of firmware upgrade.

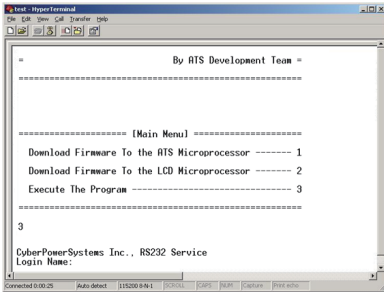

RMCARD

There are two files to update in order to upgrade the firmware:

- cpsnmpfw_XXX.bin
- cpsnmpdata_XXX.bin

Note that the XXX is not part of the file name but is where the version number in the filename is given.

Use the following steps to upgrade the firmware.

1. Download the latest firmware from cpsww.com
2. Extract the file to "C:\"
3. Open a command prompt window and navigate to "C:\"
4. Login to the Remote Management Card with FTP command, type
 - ftp (after entering ftp mode, ftp> will display in the command prompt as shown below instead of C:\)
 - ftp> open
 - To [current IP of the RMCARD] [port] (for example: To 192.168.22.126 21 [21 is the default ftp port for the RMCARD])
 - Input USER NAME and PASSWORD (same as the administrator account in Web interface default: cyber ; cyber)
5. Upload the cpsnmpfw_XXX.bin, type
 - ftp > bin
 - ftp > put cpsnmpfw_XXX.bin
6. Upgrade complete, type
 - ftp > quit

Operation

7. The system will reboot after you type "quit". This reboot will take approx. 30 seconds
8. Login to the FTP again
 - ftp
 - ftp> open
 - To [current IP of the RMCARD] [port] (for example: To 192.168.22.126 21) [21 is the default ftp port for the RMCARD])
 - Input USER NAME and PASSWORD
9. Upload cpssnmpdata_XXX.bin
 - ftp > bin
 - ftp > put cpssnmpdata_XXX.bin
10. Upgrade complete , type
 - ftp > quit
11. The system will reboot after you type "quit"

Troubleshooting

Problem	Possible Cause	Solution
ATS outlets do not provide power to connected equipment	1. Breaker tripped 2. Loose power cord	Reset Breaker, check if plug is completely connected. If the problem remains, contact technical support.
Amperage displayed on LCD Display exceeds the units capability	Overload	The load indicator shows red when overload. Reduce the load on the ATS until the overload is gone. If the problem remains, contact technical support.
Circuit breakers have tripped	1. Sustained overload 2. Excessive ambient or internal temperatures 3. Faulty breaker	Reset Breaker. If the problem remains, contact technical support.

Conformance Approvals

FCC Warning

WARNING!! This equipment has been tested and found to comply with the limits for a Class A Digital Device, pursuant to Part 15 of the FCC Rules. These limits are designed to provide reasonable protection against harmful interference in residential installation. This equipment generates, uses and can radiate radio frequency energy and, if not installed and used in accordance with the instruction manual, may cause harmful interference to radio communications. Operation of this equipment in a residential area is likely to cause harmful interference in which case the user will be required to correct the interference at his own expense.

Any special accessories needed for compliance must be specified in the instruction.

This device complies with part 15 of the FCC Rules. Operation is subject to the following two conditions: (1) This device may not cause harmful interference, and (2) this device must accept any interference received, including interference that may cause undesired operation.

Notice: (1) An unshielded-type power cord is required in order to meet FCC emission limits and also to prevent interference to the nearby radio and television reception. It is essential that only the supplied power cord be used.

(2) Use only shielded cables to connect I/O devices to this equipment.

Note: THE MANUFACTURER IS NOT RESPONSIBLE FOR ANY RADIO OR TV INTERFERENCE CAUSED BY UNAUTHORIZED MODIFICATIONS TO THIS EQUIPMENT. SUCH MODIFICATIONS COULD VOID THE USER'S AUTHORITY TO OPERATE THE EQUIPMENT.

The Class A digital apparatus meets all requirements of the Canadian Interference-Causing Equipment Regulation.

Cet appareil numérique de la class A respecte toutes les exigences du Règlement sur le matériel brouilleur du Canada.

Customer Service & Warranty

Product Registration

Thank you for purchasing a CyberPower product. Prompt product registration entitles coverage under the Limited Warranty and also allows the opportunity to be notified of product enhancements, upgrades, and other announcements. Registration is quick and easy at www.CPSww.com under "Support".

CyberPower International

Feel free to contact our Tech Support department with installation, troubleshooting, or general product questions.

CyberPower Systems, Inc.

Web: www.cpsww.com

CyberPower Systems (USA), Inc.

Phone: (952)403-9500 Toll-free: (877)297-6937

Email: tech@cpsww.com

Web: www.CPSww.com

Add: 4241 12th Avenue E., Suite 400 Shakopee, MN 55379

Hours of Operation: Monday-Friday 8:00 AM-5:00 PM (CST)

Limited Warranty

Read the following terms and conditions carefully before using the CyberPower ATS series. By using the Product, you consent to be bound by and become a party to the terms and conditions of this Limited Warranty. If you do not agree to the terms and conditions of this Warranty, you should return the Product for a full refund prior to using it.

Who Is Providing This Warranty?

CyberPower Systems, Inc. provides this Limited Warranty.

What Does This Warranty Cover?

This warranty covers defects in materials and workmanship in the Product under normal use and conditions.

What Is The Period of Coverage?

CyberPower provides a 3-Year limited warranty to the original purchaser who owns the Product.

Who Is Covered?

This warranty only covers the original purchaser. Coverage ends if you sell or otherwise transfer the Product.

How Do You Get Service?

1. You can use the contact information mentioned above for instructions.
2. When you contact CyberPower, identify the Product, the Purchase Date, and the item(s) of Connected Equipment. Have information on all applicable insurance or other resources of recovery/payment that are available to the Initial Customer and Request a Claim Number.
3. You must provide a purchase receipt (or other proof of the original purchase) and provide a description of the defect.

What Will We Do To Correct Problems?

CyberPower will inspect and examine the Product.

If the Product is defective in material or workmanship, CyberPower will repair or replace it at CyberPower's expense, or, if CyberPower is unable to or decides not to repair or replace the Product (if defective) within a reasonable time, CyberPower will refund to you the full purchase price you paid for the Product (purchase receipt showing price paid is required).

If it appears that our Product failed to protect any equipment plugged into it, we will also send you forms for making your claim for the connected equipment. We will repair or replace the equipment that was damaged because of the failure of our Product or pay you the fair market value (NOT REPLACEMENT COST) of the equipment at the time of the damage. We will use Orion Blue Book, or another third-party valuation guide, or eBay, craigslist, or other source to establish that amount. Our liability is limited to the amount, if any, stated in the Technical Specifications.

Customer Service & Warranty

Who Pays for Shipping?

We pay when we send items to you; you pay when you send items to us.

What Are Some Things This Warranty Does Not Cover?

1. This Warranty does not cover any software that is damaged or needs to be replaced due to the failure of the Product or any data that is lost as a result of the failure or the restoration of data or records, or the reinstallation of software.
2. This Warranty does not cover or apply to: misuse, modification, operation or storage outside environmental limits of the Product or the equipment connected to it, nor for damage while in transit or in storage, nor if there has been improper operation or maintenance, or use with items not designed or intended for use with the Product, such as laser printers, appliances, aquariums, medical or life support devices, etc.

What Are The Limitations?

1. This Warranty does not apply unless the Product and the equipment that was connected to it were connected to properly wired and grounded outlets (including compliance with electrical and safety codes of the most current electrical code), without the use of any adapters or other connectors.
2. The Product must have been plugged directly into the power source and the equipment connected to the Product must be directly connected to the Product and not "daisy-chained" together in serial fashion with any extension cords, another Product or device similar to the Product, surge suppressor, or power tap. Any such installation voids the Limited Warranty.
3. The Product and equipment connected to it must have been used properly in a suitable and proper environment and in conformance with any license, instruction manual, or warnings provided with the Product and the equipment connected to it.
4. The Product must have been used at all times within the limitations on the Product's VA capacity.
5. The sole and exclusive remedies of the Initial Customer are those provided by this Warranty

Appendix A-Hyper Terminal

Hyper Terminal software can be used for basic ATS configuration. It utilizes a text-based interface and menu system. Navigation through the interface is done by typing the number of the menu option and pressing the Enter key.

Note: The session will timeout and logout after 3 minutes of inactivity. Menu options are shown below:

[Main Menu]

1. Utility Configuration
2. Outlet Manager (Switched Series Only)
3. Load Configuration
4. Network Settings
5. System Configuration
6. Account Settings
7. Configure System to Default
8. Logout

[Utility Configuration]

1. Preferred Source: A
2. Sensitivity: High
3. Voltage Range: Medium
4. Frequency Deviation: 1 Hz
5. Nominal Voltage: 230 V
6. Wide Voltage Range: 30 V
7. Medium Voltage Range: 23 V
8. Narrow Voltage Range: 16 V
9. Set Load Restriction

[Outlet Manager]

1. Outlet Control
2. Outlet Configuration

[Load Configuration]

1. Device Threshold Configuration
2. Bank 1 Threshold Configuration
3. Bank 2 Threshold Configuration
4. Bank 3 Threshold Configuration

[Network Setting]

Physical MAC Address: 00-0C-15-00-00-01

1. System IP: 192.168.20.240
2. Subnet Mask: 255.255.255.0
3. Default Gateway: 192.168.20.254
4. DHCP: Enabled
5. Http Port: 80
6. Http Access: Enabled

[System Configuration]

1. Name: PDU15SW10ATNET
2. Location: Server Room
3. Contact: Administrator

[Account Setting]

1. Administrator

[Configure System to Default]

Sure to Configure System to Default

1. Reset ATS
2. Reset ATS (TCP/IP Settings Reserved)

Appendix B-Power Device Network Utility

Overview

The CyberPower Power Device Network Utility is an easy-to-use interface which is used for establishing IP addresses on CyberPower ATS devices.

Installation

Step 1. Insert the CD labeled “Software Installation CD” into the CD/DVD drive.

Step 2. Select Power Device Network Utility from the installation menu (Shown in Figure 1.).

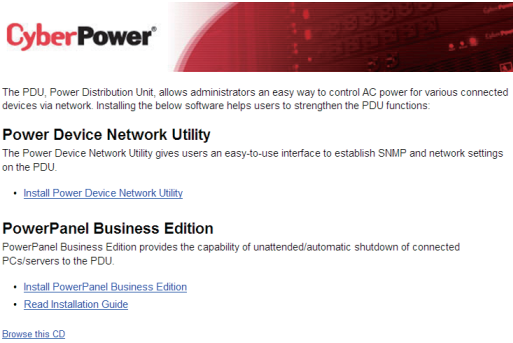

Figure 1. Installation Menu

Step 3. Select Next in the software wizard.

Step 4. Choose an installation directory and user settings. Select Next (Shown in Figure 2.).

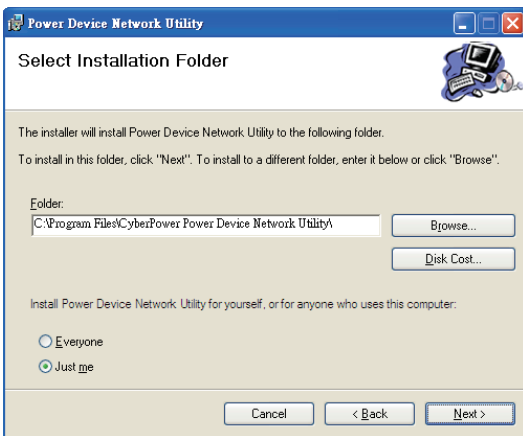

Figure 2. Installation folder and settings

Step 5. Select Next to confirm the settings and install.

Step 6. Select Close to finalize the installation.

Launch Program

To launch the Power Device Network Utility and get started, select Programs from the Start menu in Windows and locate the new folder and icons for Power Device Network Utility. Select Power Device Network Utility from the program folder (Shown in Figure 3.).

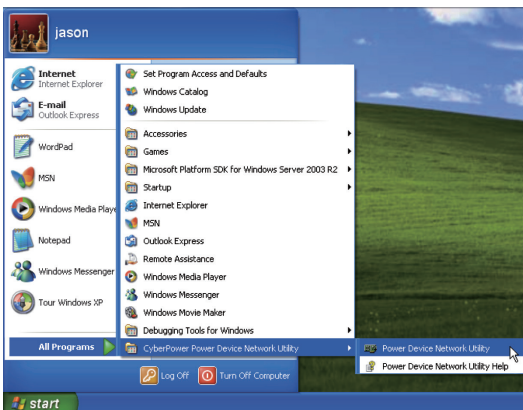

Figure 3. Power Device Network Utility

Appendix B-Power Device Network Utility

Getting Started

The Power Device Network Utility scans the network for devices with MAC addresses that match CyberPower network hardware. Once found, the device(s) can then be figured with a specific IP address, subnet mask, and gateway address. This allows the device(s) to function properly on the network and interface with CyberPower Management Console.

Step 1. Select the appropriate ATS device from the Equipment List (Shown in Figure 4.).

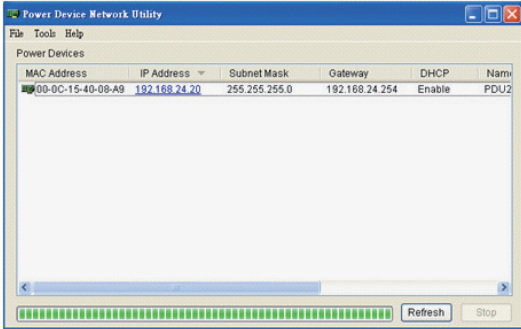

Figure 4. Equipment List

Note: If the ATS does not appear on the list, click the Refresh button to rescan the network. If it still does not appear, ensure that the ATS is turned on and is installed correctly.

Pressing Stop will cancel the scan/refresh process.

Note: If your computer has a software firewall installed, you may see a Windows Security Alert message (Shown in Figure 5.).

In Windows XP SP2, the default firewall alert message is shown as Figure 5. You need to allow the Power Device Network Utility access through the firewall.



Figure 5. Windows Security Alert

Step 2. Assign a valid IP Address to the ATS

With the appropriate device selected from the Equipment List, open the Network Settings menu (shown in Figure 6.) [Tools=>Device Setup]. In the Device Network Setting Menu, enter a valid IP address, subnet mask, and gateway address to setup the ATS device.

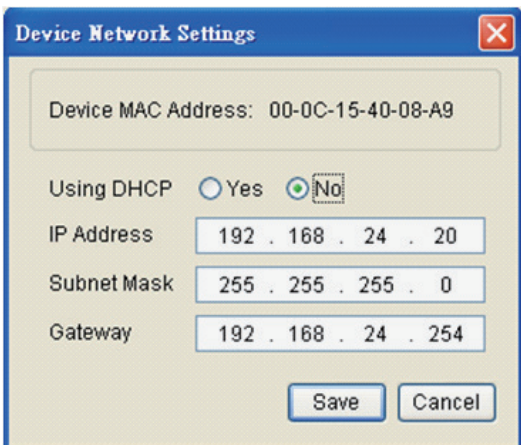

Figure 6. Network Setting Menu (Device Setup)

Appendix B-Power Device Network Utility

Step 3. Authentication

Enter the user name and password of the ATS device at the Authentication menu (shown in Figure 7.)

Note: The default username is “**cyber**” and the default password is “**cyber**”.



Figure 7. Authentication screen

Advanced Settings

Timeout Settings

The Timeout Setting (Shown in Figure 8.). [Edit=>Timeout Settings] is used to specify the wait time when scanning for network ATS devices. When there are many devices on the local network, it may take extended periods of time to locate all the devices. The timeout function is used to limit the search time.

The default setting is 3 seconds. Valid values are 3 to 60 seconds.

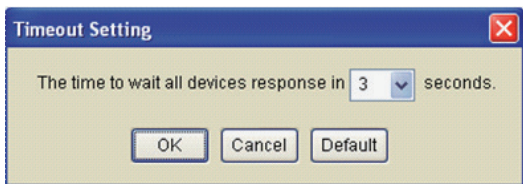

Figure 8. Timeout Setting



CyberPower[®]
Reliability. Quality. Value.

CyberPower Systems, Inc.
www.CPSww.com

K01-0000322-00