



NS-AW350 / NS-AW350W

INDOOR / OUTDOOR SPEAKER SYSTEM

CONTENTS

CONSUMER PRECAUTIONS	2
UNPACKING	3
MOUNTING THE SPEAKERS	4~5
CONNECTIONS TO YOUR AMPLIFIER	6
SETTING UP THE SPEAKERS	7
SPECIFICATIONS	8
WARRANTY	9

THIS PAGE INTENTIONALLY LEFT BLANK





CONSUMER PRECAUTIONS

Read these precautions carefully before operating your NS-AW350 / NS-AW350W speakers.

- When installing these speakers outdoors, try to minimize their exposure to rain and snow by mounting the speaker in corners or under eaves.
- Since these speakers can be wall mounted, it is essential that they are firmly secured. **Be sure to consult a reliable source about the best type of mounting solution for your particular wall's construction. Secure installation is the purchaser's responsibility.**
- Do not attach the speakers to thin plywood or soft wall surface materials as the screws may tear free, causing the speakers to fall and be damaged, or result in personal injury.
- Do not fasten the speakers to walls with nails, adhesives, or other unsafe hardware. Long-term use and vibrations may cause them to pull free.
- Do not place the speakers where they are likely to be knocked over or struck by falling objects. Stable placement will also ensure better sound performance.
- Placing the speakers on the same stand or shelf as a turntable can result in feedback.
- Never touch the woofer or tweeter units with your hands or expose them to excessive physical shock. If they are dented or bent, the sound will be distorted.
- Lower the power amplifier / receiver volume control before changing input sources. Never change input sources (for example, FM to CD) at high listening levels. Always turn the receiver / amplifier unit off when installing or removing input cables.
- If you notice distortion, reduce the volume control on your power amplifier / receiver to a lower setting. Never allow your power amplifier to be driven into "clipping."
- Do not attempt to clean the speakers with chemical solvents as this might damage the finish. To clean, wipe the speakers with a dry, soft cloth.
- **Secure placement or installation is the owner's responsibility. YAMAHA shall not be liable for any accident caused by improper placement or installation of speakers.**

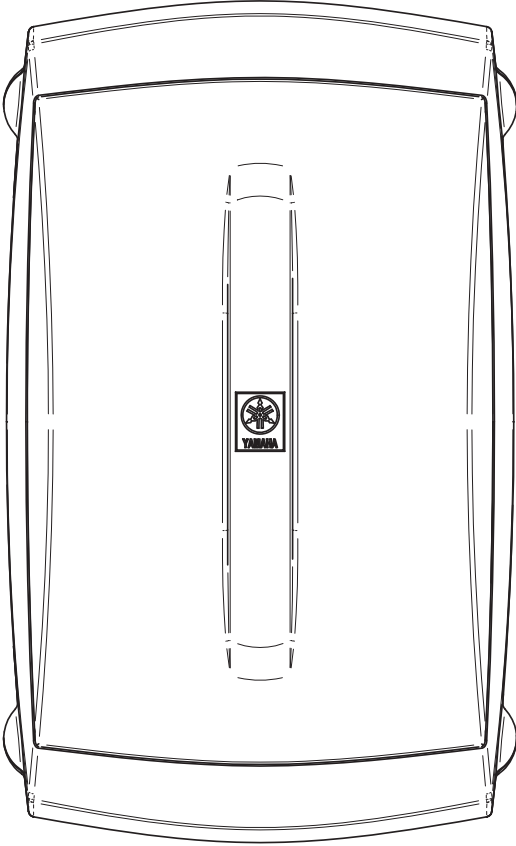
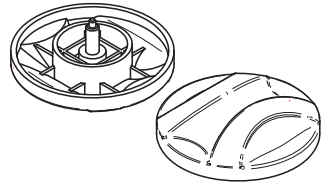
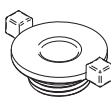
UNPACKING

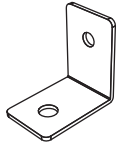
After unpacking, inspect the contents to confirm the following items are included:

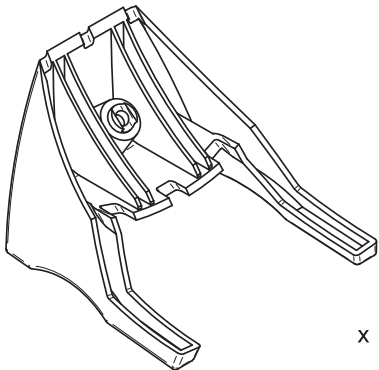
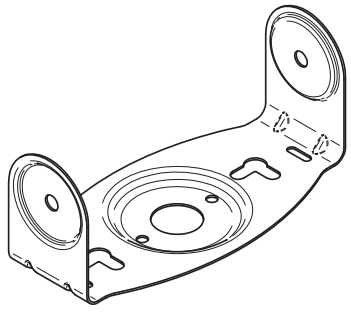
<p>Speakers</p>  <p>x 2</p>	<p>Large bracket screws</p>  <p>x 4</p>
<p>Screw for mega mounting plates</p>  <p>x 2</p>	
<p>Screw for base or for L-Bracket</p>  <p>x 2</p>	
<p>L-Bracket for safety chain</p>  <p>x 2</p>	
<p>Safety chain</p>  <p>x 2</p>	
<p>Base</p>  <p>x 2</p>	<p>Bracket</p>  <p>x 2</p>

MOUNTING THE SPEAKERS

The speakers can be placed on a bookshelf or wall/ceiling-mounted with optional speaker brackets using 1/4"-20 screws to fasten the optional bracket into the threaded inserts located on the back of the speakers. To wall / ceiling mount the speakers, use the supplied mounting bracket (see below).

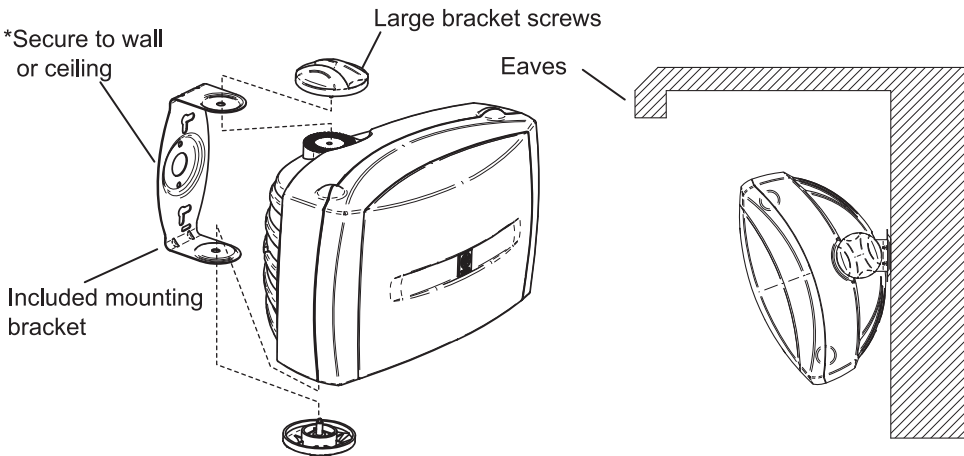

OUTDOOR NOTE :
The supplied mounting brackets allow the speakers to be mounted in corners or under eaves to minimize their exposure to rain or snow.

1. Use the bracket as a template to mark the locations of the key hole slots on the mounting area.
2. Next, use appropriate hardware (not included) to securely fasten the bracket to the wall/ceiling.
3. Position the speaker in the bracket and secure the speaker by using the two large bracket screws included (see above).

If the mega mounting plate is already installed on the outside wall, the speaker can also be mounted using the following procedure:

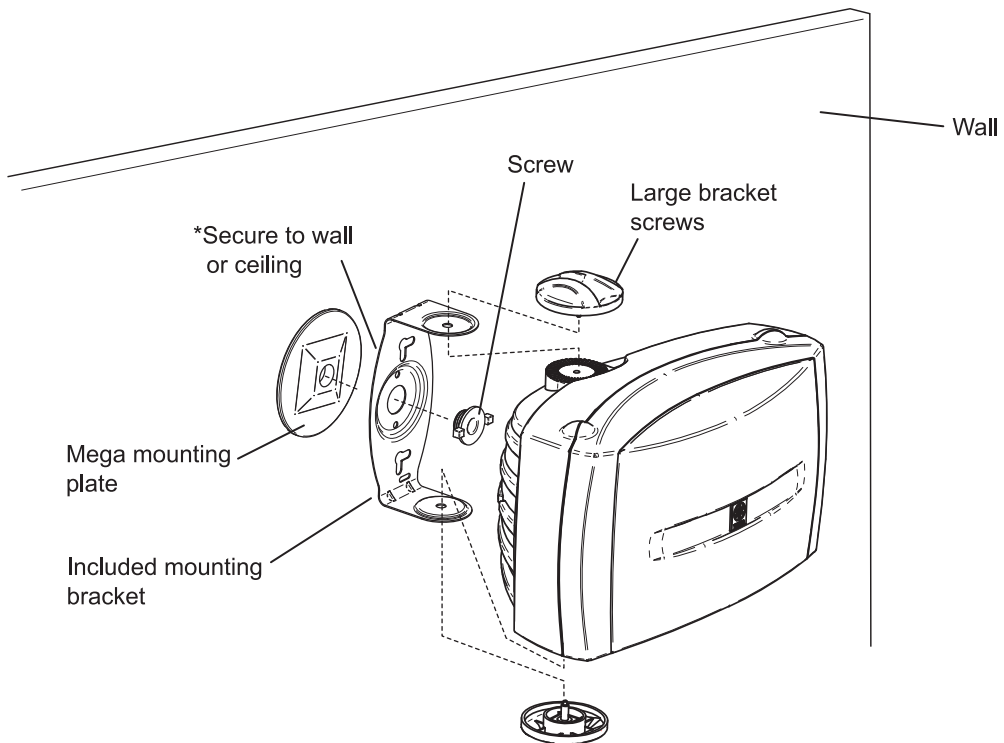

***CAUTION:**

Be sure to consult a reliable source for the best type of fasteners for your particular wall / ceiling construction.
Secure installation is the purchaser's responsibility.

When using speaker brackets to mount the speaker on a wall, please use safety wire between the speaker and the bracket to prevent the speaker from falling.

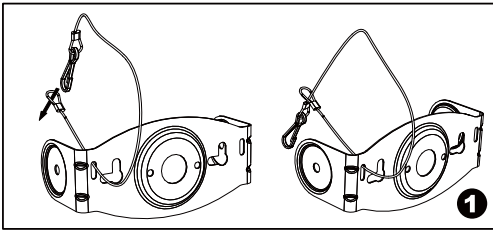

1 Insert the clasp of the safety wire through the bracket and loop.

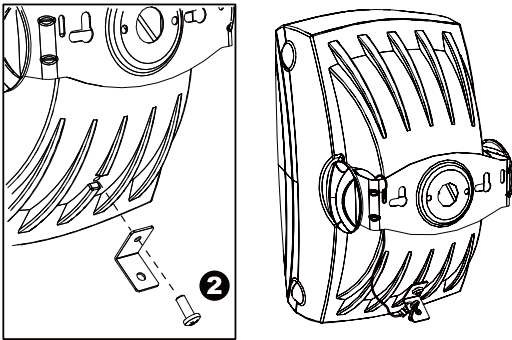

2 Attach the L-bracket to the speaker with screw.

When mounting the speakers vertically or horizontally, attach the base or side knobs to the speakers according to the selected position.

Vertical Placement

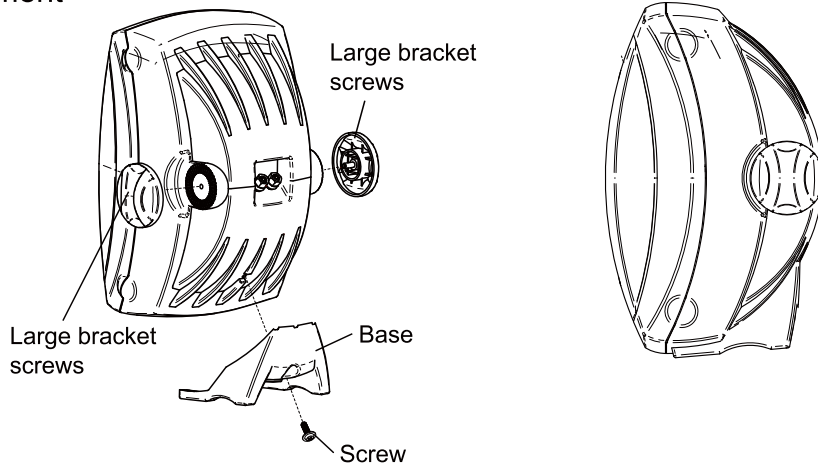

Horizontal Placement

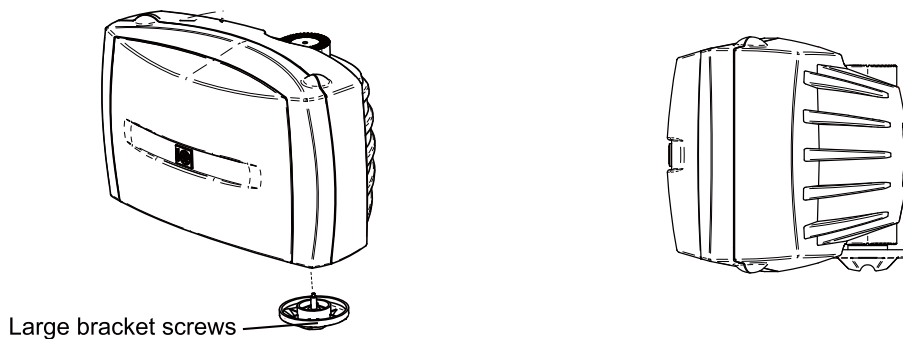

CONNECTIONS TO YOUR AMPLIFIER

Before making connections, make sure that the amplifier is switched off.

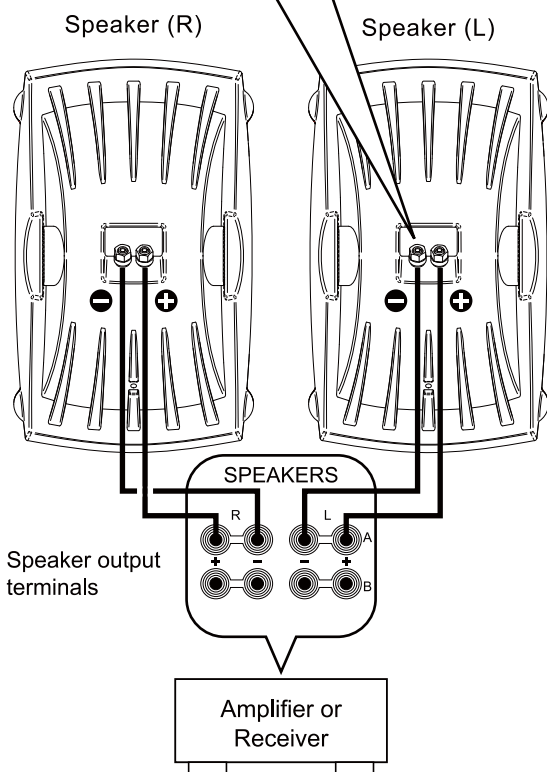
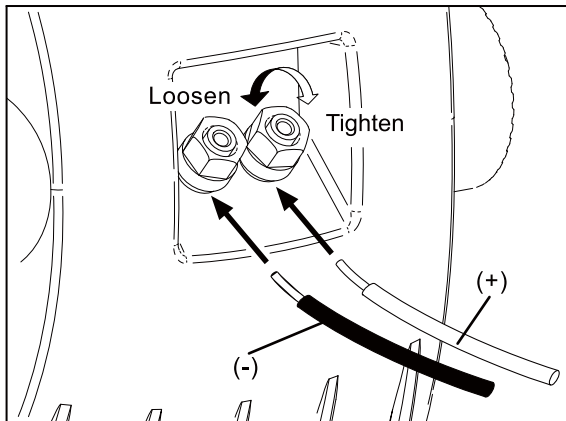

CONNECTIONS

- Connect the screw-type input terminals at the rear of the speakers to the speaker output terminals of the amplifier (or receiver) with speaker cables (not included).
- One side of the speaker cable is (+) and the other side is (-). Connect the (+) terminals on the amplifier (or receiver) and speakers using the (+) side. Connect the (-) terminals on both components using the (-) side of the cable.
- Connect each speaker making sure not to reverse the polarity (+,-). If the speaker is connected with reverse polarity, the sound will be unnatural and lack bass.

How to connect

- ① Loosen the knob.
- ② Insert the bare wire [Remove the insulation coating at the end of each speaker cable by twisting the coating off].
- ③ Tighten the knob and secure the cable.
Test the firmness of the connection by pulling lightly on the cable near the terminal.

Note

Do not let the bare speaker wires touch each other as this could damage the speaker or amplifier (or both).

When using a banana plug

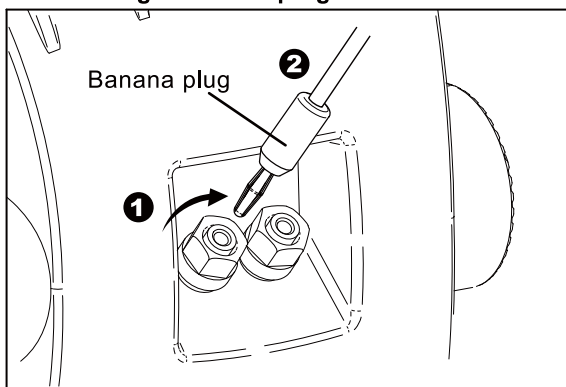

- ① Tighten the terminal knob.
- ② Insert the banana plug into the terminal.

SETTING UP THE SPEAKERS

INDOOR PLACEMENT

This speaker is designed to be used as a main, surround or effects speaker.

- **Main speaker** placement should be separated by a distance of 6-10ft. If they are placed too close together, there will be a reduction in the stereo effect. Conversely, if placed too far apart, the so called "middle-omission" effect will occur and the vocal center fill will be lost. Speaker height should be at least at ear level.
- **Center channel speakers** should be centered and placed above or below the TV.
- **Surround speakers** should ideally be placed behind the listening area, at least as far apart as the main speakers and up to 2 additional feet apart per side. Ideally, the height of the speaker should be at ear level or preferably somewhat higher.

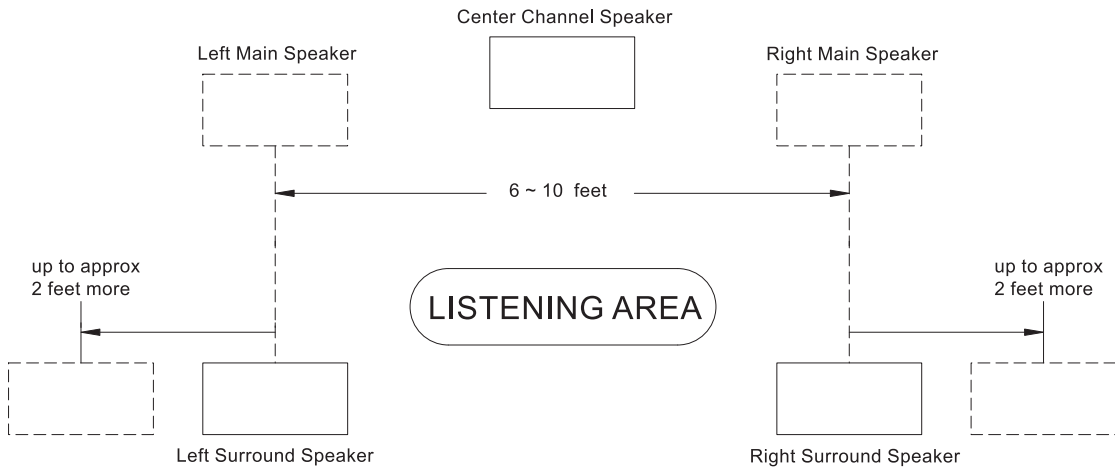

OUTDOOR PLACEMENT

Your speaker system has water-resistant enclosures that protect the speakers from the elements when mounted outdoors. These speakers are designed with a wide dispersion pattern, which means you will get good sound quality over a large listening area (100ft² to approximately 400 ft²). Please note if the listening area is too large, and the speakers are positioned too far apart, "middle-omission" effect (lack of sound in an area between the speakers) will occur and/or "hot spots" (loud sound near the speaker) will develop.

Try to place the speakers between 6'-10' apart for good stereo listening. It is suggested for larger areas (over 400ft² to about 600ft²) that two pairs of speakers be used.

See below:

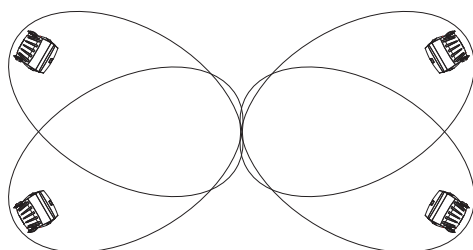

NOTE:

1 pair of speakers should be used for every 200-400 ft

SPECIFICATIONS

Model.....	NS-AW350 / NS-AW350W
Type.....	2-Way Acoustic Suspension
Speaker Woofer.....	6.5" High Compliance Poly Mica Filled Cone and Rubber Surround
Tweeter.....	1" PEI Dome
Frequency Response.....	45Hz to 40kHz (87dB)
Impedance.....	6 Ohms
Nominal Input.....	40 watts
Maximum Input.....	130 watts
Sensitivity (dB/2.83v,1m).....	87 dB
Dimensions (HxWxD).....	13.5" x 7.2" x 6.25"
Weight.....	6.39 lb. (102.3 oz)

*Specifications subject to change without notice due to product improvements.

YAMAHA CORPORATION OF AMERICA

6600 ORANGETHORPE AVE., BUENA PARK, CA 90620

Yamaha loudspeakers are designed and manufactured to provide a high level of trouble-free performance. Yamaha Corporation of America is proud of the experienced craftsmanship that goes into each and every Yamaha loudspeaker. Yamaha sells its loudspeakers only through a network of high quality, specialty authorized dealers and is pleased to offer the following Limited Warranty, which applies only to products purchased from our authorized dealers. We suggest that you read the Limited Warranty thoroughly, and invite you to contact your authorized Yamaha dealer or the Yamaha Corporation of America service department if you have any questions.

LIMITED WARRANTY INDOOR / OUTDOOR SPEAKER SYSTEM

Duration of Warranty:

This Speaker System is covered by this warranty for a period of two (2) years beginning from the date of first consumer purchase.

What is Covered and What is Not Covered?

This warranty covers all defects in materials or workmanship in this product, but DOES NOT COVER the following:

- (1) Damage, deterioration or malfunction resulting from:
 - a. Accident, negligence, misuse, abuse, improper installation or operation or failure to follow instructions contained in your Owner's manual.
 - b. Any shipment of the product. (Claims must be presented to the carrier.)
 - c. Repair or attempted repair by anyone other than Yamaha or an authorized Yamaha Preferred Customer Service Center.
- (2) Any unit which has been altered or on which the serial number has been defaced, modified or removed.
- (3) Normal wear and any periodic maintenance.
- (4) Any unit which has not been purchased from an authorized YAMAHA dealer in the U.S.A. If you are uncertain as to whether a dealer has been authorized by YAMAHA, please contact YAMAHA's Service Department.
- (5) Any unit used for industrial or commercial purposes.

Who may enforce the warranty:

This warranty is enforceable only by the original purchaser.

What we will pay for and what you must pay for:

YAMAHA will repair or replace units covered by this warranty, without charge to the consumer for labor or materials. YOU ARE RESPONSIBLE FOR ANY INSTALLATION OR REMOVAL CHARGES AND FOR ANY INITIAL SHIPPING CHARGES, if the Components must be shipped for warranty service. However, we will pay the return shipping charges to any destination within the U.S.A. if the repairs are covered by the warranty.

How you can get Warranty Service:

- (1) YAMAHA Speaker Systems requiring service must be delivered to any authorized YAMAHA Service Center within the fifty states of the U.S.A., the District of Columbia or Puerto Rico. Warranty service is not available at any other location or outside the U.S.A.
- (2) Units shipped for service should be packed securely and must be accompanied by a detailed explanation of the problem(s) requiring service And Bill of Sale as proof of Warranty coverage.
- (3) Warranty registration is not required for Warranty coverage.

Limitation of Implied Warranties:

ANY IMPLIED WARRANTIES, INCLUDING WARRANTIES OF MERCHANTABILITY AND FITNESS FOR A PARTICULAR PURPOSE, ARE LIMITED IN DURATION TO THE LENGTH OF THIS WARRANTY.

Exclusion of Damages

YAMAHA'S LIABILITY, FOR ANY DEFECTIVE PRODUCT, IS LIMITED TO REPAIR OR REPLACEMENT OF THE PRODUCT, AT OUR OPTION. YAMAHA SHALL NOT BE LIABLE FOR INCIDENTAL OR CONSEQUENTIAL DAMAGES OR DAMAGES OF ANY OTHER KIND OR CHARACTER BECAUSE OF PRODUCT DEFECTS.

SOME STATES DO NOT ALLOW LIMITATIONS ON HOW LONG AN IMPLIED WARRANTY LASTS AND/OR DO NOT ALLOW THE EXCLUSION OR LIMITATION OF INCIDENTAL OR CONSEQUENTIAL DAMAGES, SO THE ABOVE LIMITATIONS AND EXCLUSIONS MAY NOT APPLY TO YOU. THIS WARRANTY GIVES YOU SPECIFIC LEGAL RIGHTS, AND YOU MAY ALSO HAVE OTHER RIGHTS WHICH VARY FROM STATE TO STATE.

Should you have any questions about service received or if you need assistance in locating an authorized Yamaha Service Center, please contact:



CUSTOMER SERVICE

YAMAHA CORPORATION OF AMERICA

6600 ORANGETHORPE AVE., BUENA PARK, CA 90620-1373

<http://usa.yamaha.com> Phone: (800)292-2982

YAMAHA products are backed by a nationwide network of high quality YAMAHA authorized Service Centers, providing prompt, courteous and professional service.

THIS PAGE INTENTIONALLY LEFT BLANK



YAMAHA CORPORATION OF AMERICA
6600 ORANGETHORPE AVENUE
BUENA PARK, CA 90620
<http://usa.yamaha.com>
Phone: (800) 292-2982