

	RGS134-1Y	RGS134-10-1Y	RGS134A-10-1
 Rack Grounding Strip	1	10	10
 M6 Screw	3	30	—
 12-24 Screw	3	30	—
 M5 Screw	3	—	30
 10-32 Screw	3	—	30
 Universal Grounding Sticker	1	10	10
 Cleaning Pad	1	1	1
 AntiOx	1	1	1

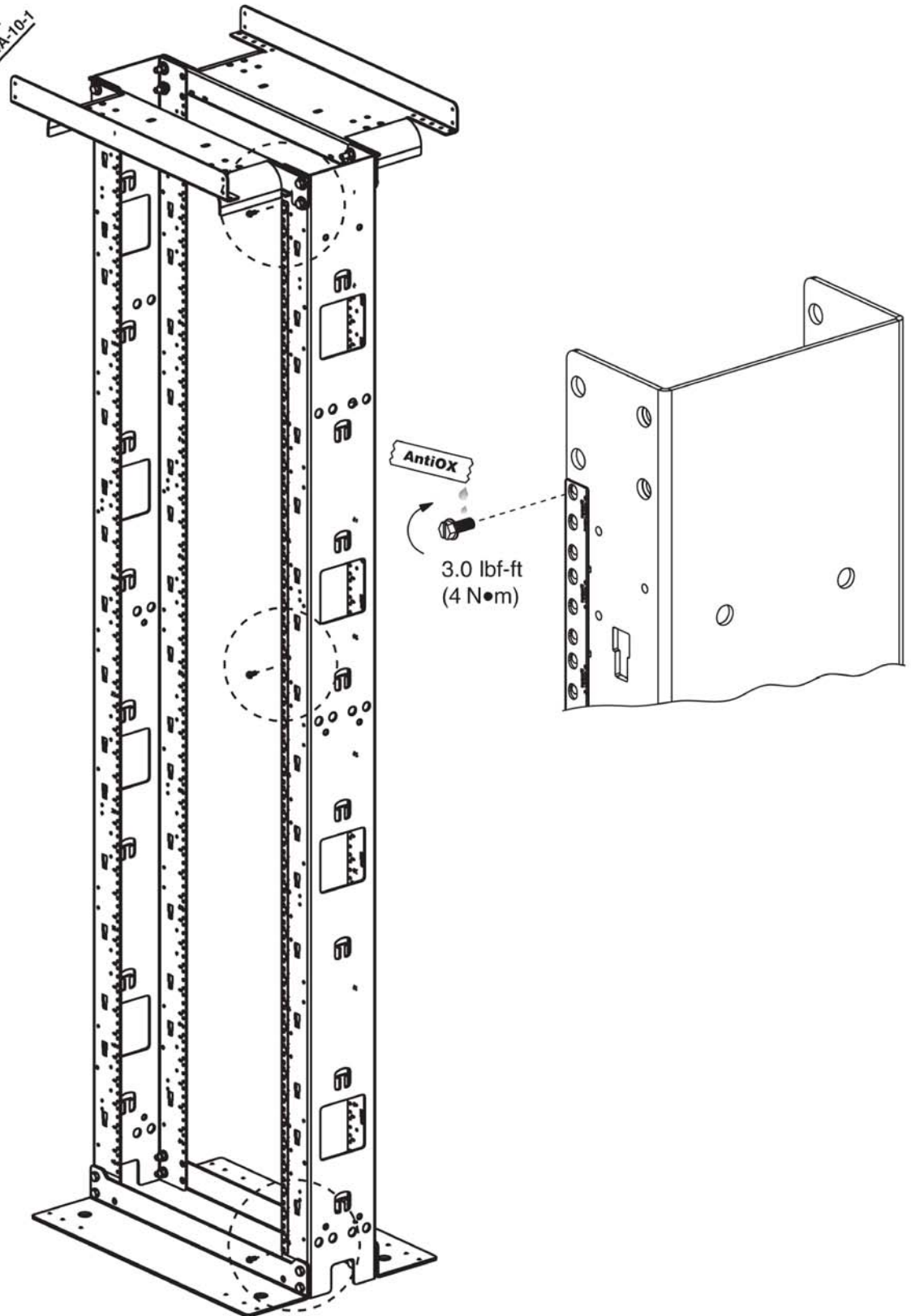

RGCBNJ660PY

RGCBNJ460P

	1
Common Bonding Network Jumper	
	2
M6 Screw	
	2
12-24 Screw	
	2
M5 Screw	
	2
10-32 Screw	
	1
HTAP	
	1
Pad	
	1
AntiOx	

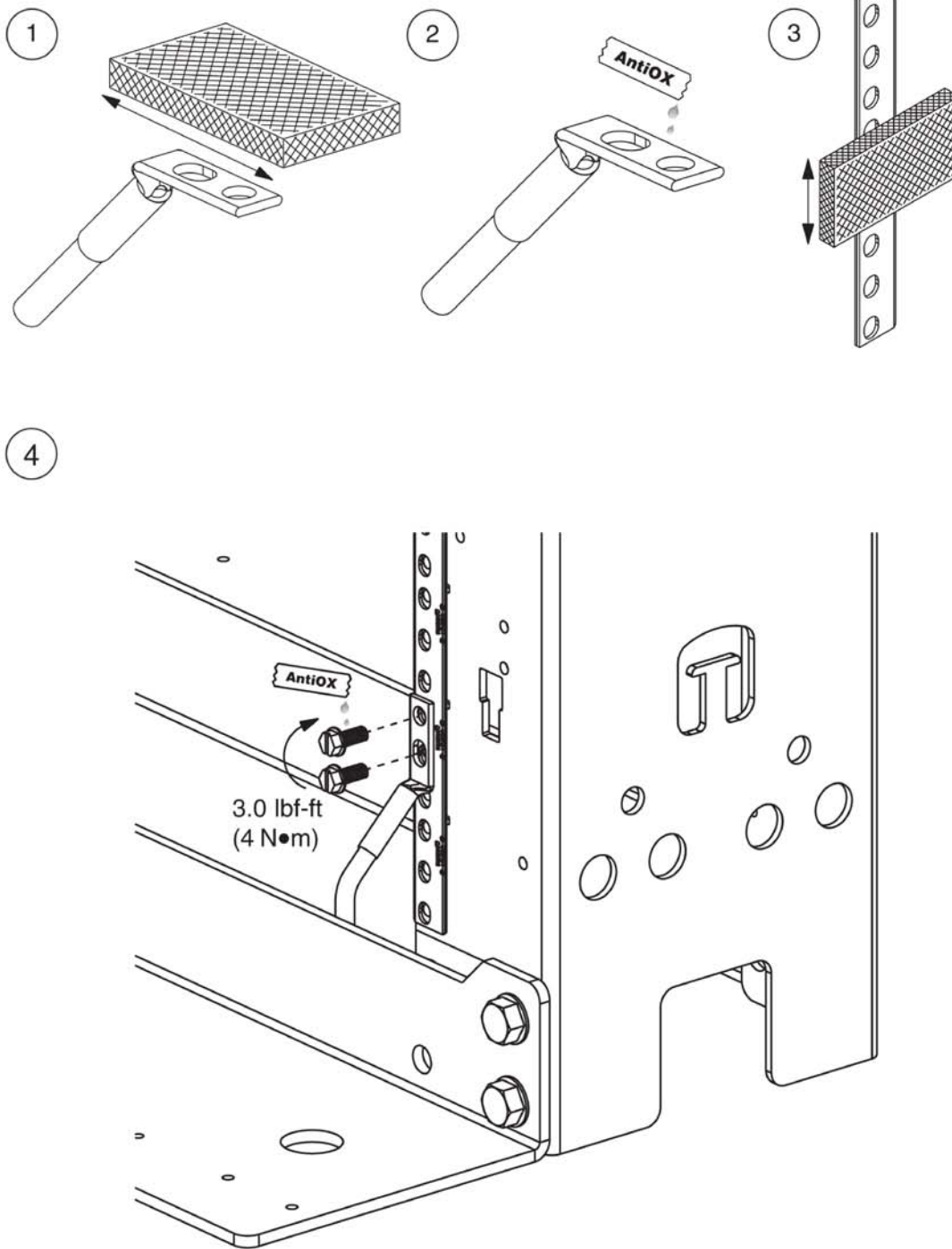

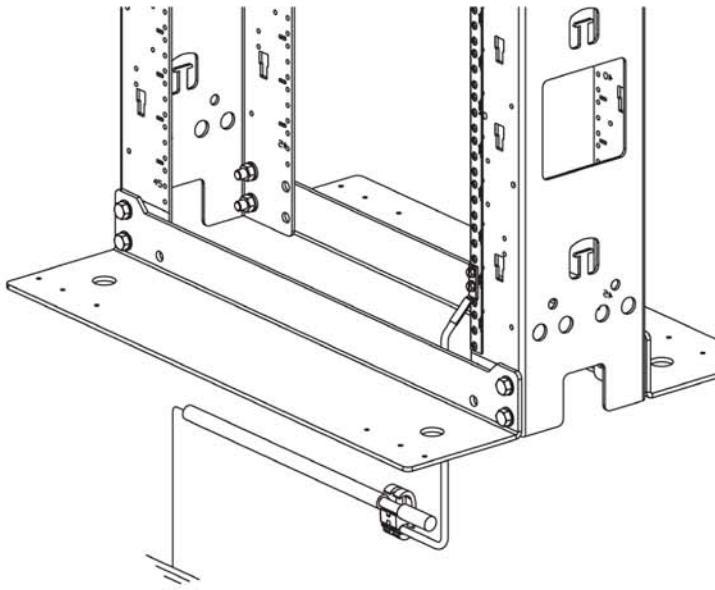

5

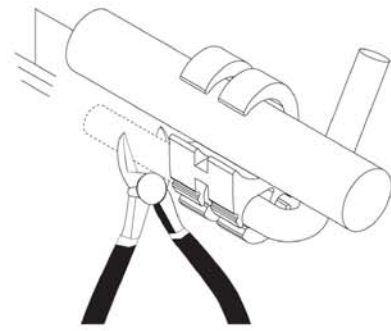

6

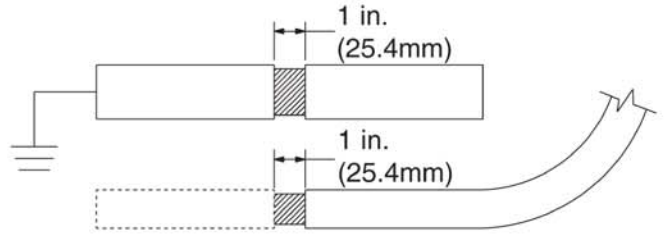

7

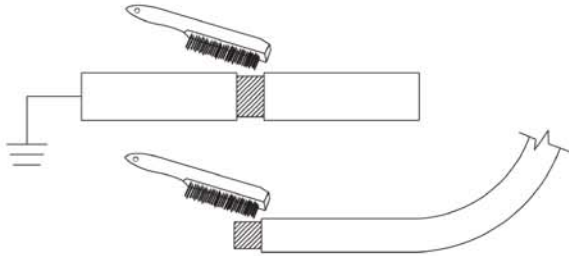

8

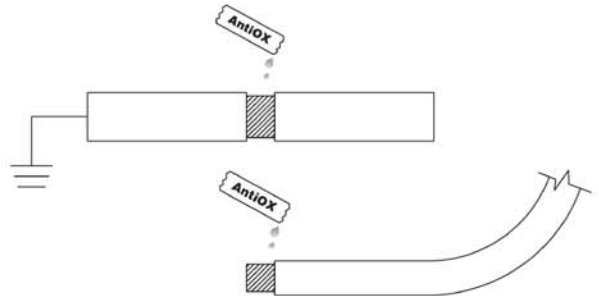

9

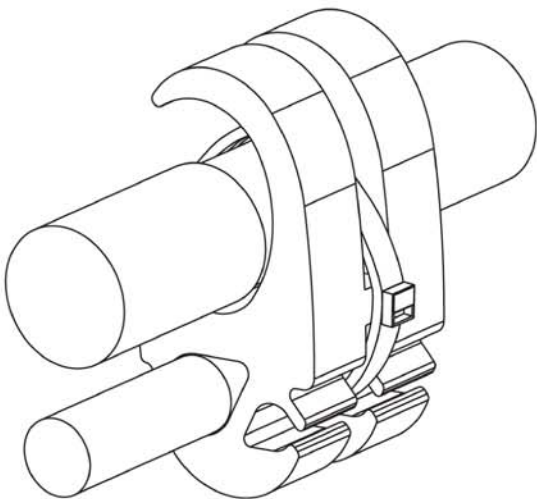

10

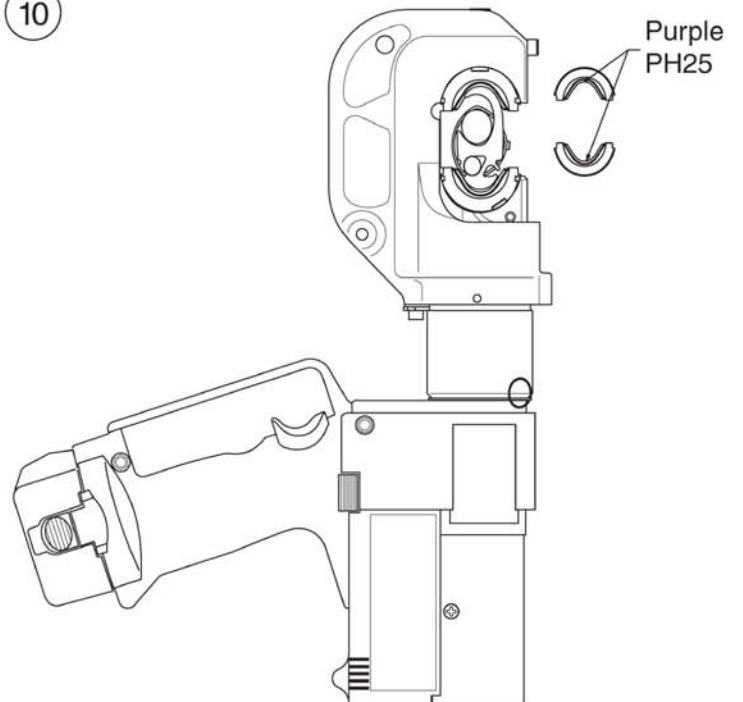

	RGEJ624PHY	RGEJ1024PHY	RGEJ624PFY	RGEJ1024PFY	RGEJ636PFY	RGEJ1036PFY	RGEJ657PFY	RGEJ1057PFY
Equipment Jumper 24" (0.61m)	1	1	—	—	—	—	—	—
Equipment Jumper 24" (0.61m)	—	—	1	1	—	—	—	—
Equipment Jumper 36" (0.91m)	—	—	—	—	1	1	—	—
Equipment Jumper 57" (1.45m)	—	—	—	—	—	—	1	1
M6 Screw	2	2	2	2	2	2	2	2
12-24 Screw	2	2	2	2	2	2	2	2
M5 Screw	2	2	2	2	2	2	2	2
10-32 Screw	2	2	2	2	2	2	2	2
Cleaning Pad	1	1	1	1	1	1	1	1
AntiOx	1	1	1	1	1	1	1	1

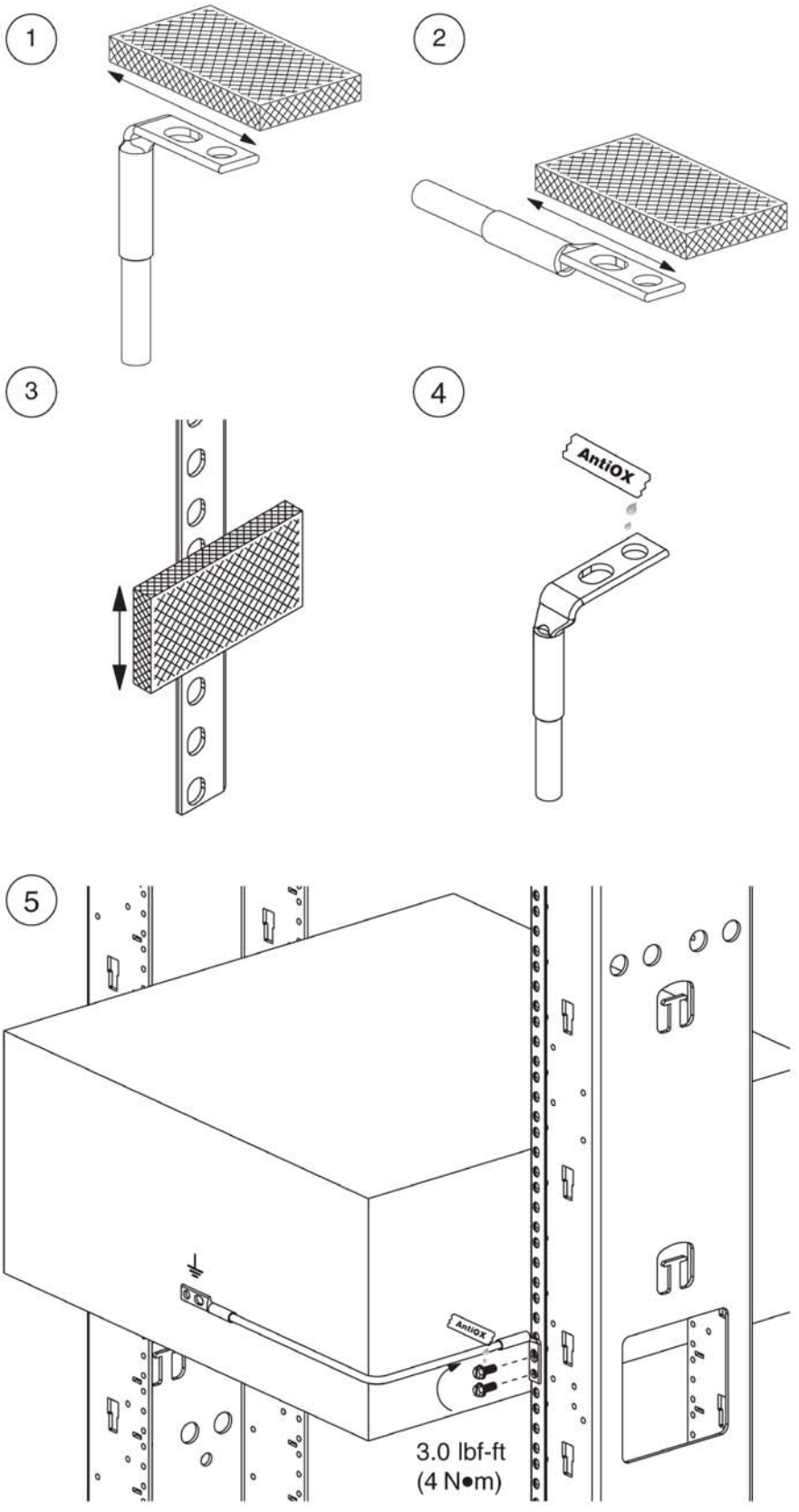

For Instructions in Local Languages
and Technical Support:

www.panduit.com/resources/install_maintain.asp



www.panduit.com

E-mail:
cs@panduit.com

Fax:
708-444-6993