



MorphoWave Compact

Quick User Guide

2018_2000035854 – V1

All descriptions, illustrations, and specifications in this brochure should be considered approximate and may relate to optional equipment or feature

Table of Contents

Color	Step	Content
	One	Overview
	Two	Wiring
	Three	Communication
	Four	SDAC (Single Door Access Control)
	Five	Administration
	Six	Software
	Seven	Enrollment
	Eight	Optional features

Regulatory, safety and environmental notices



Products bearing the CE marking comply with one or more of the following EU Directives as may be applicable:

- Low Voltage Directive 2006/95/EC
- EMC Directive 2004/108/EC
- R&TTE Directive 1999/5/EC
- Ecodesign Directive 2009/125/EC
- RoHS Directive 2011/65/EU.

Compliance with these directives is assessed using applicable European Harmonised Standards.<<<



The installation of this product should be made by a qualified service Person and should comply with all local regulations.

It is strongly recommended to use a class II power supply at 12V-24V and 2.5 A. min (at 12V) in conformity with Safety Electrical Low Voltage (SELV). The power supply cable length should not exceed 10 meters.

This system must be installed in accordance with the National Electrical Code (NFPA 70), and the local authority having jurisdiction.

This product is intended to be installed with a power supply complying with IEC60950-1, in accordance with the NEC Class 2 requirements; or supplied by a listed IEC60950-1 external Power Unit marked Class 2, Limited Power source, or LPS and rated 12VDC, 2.5 A minimum or 24VDC, 1.25 A minimum.

In case of building-to-building connection it is recommended to connect 0V to ground. Ground cable must be connected with the terminal block Power Ground.

Note that all connections of the MorphoWave Compact terminal described hereafter are of SELV (Safety Electrical Low Voltage) type.



This symbol means do not dispose of your product with your other household waste. Instead, you should protect human health and the environment by handing over your waste equipment to a designated collection point for the recycling of waste electrical and electronic equipment.

Product Overview

MorphoWave Compact provides an innovative and effective solution for access control applications using very fast acquisitions of four (4) fingerprints without any contact.

- ◆ Access control and Time & Attendance
- ◆ Biometric authentication by a hand swipe through the active volume without contact
- ◆ IDEMIA False finger detection algorithms
- ◆ Simple and ergonomic man-machine interface
- ◆ Contactless card reader (MIFARE Classic, MIFARE Plus, DESFire, HID® Iclass*, HID® PROX*)
- ◆ Intercom system
- ◆ Universal connectivity (Gigabit Ethernet, Wi-Fi™, RS485/422, Wiegand, Dataclock)
- ◆ Anti-tamper sensor

* Depending on product version



Step one : overview

MorphoWave Compact Checklist

Product packaging checklist:

QTY	ITEM
1	MorphoWave Compact terminal
1	Wall Mounting Plate
1	Documentation package

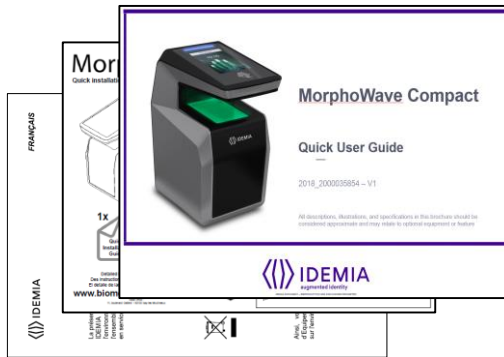
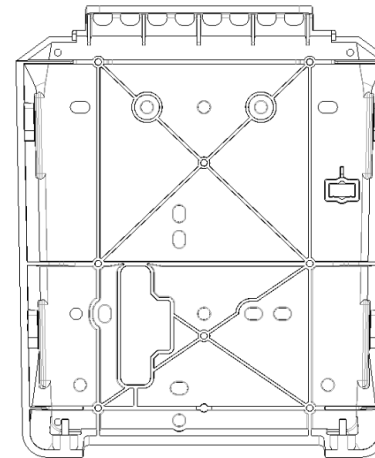

Step one : overview

Electronic documentation is provided in Adobe® Acrobat® format (PDF). Adobe® Acrobat® Reader is available at <http://www.adobe.com>.

Terminal Implementation

To secure an access, IDEMIA recommends installing the MorphoWave Compact terminal as a part of a typical Access Control system, which consists of the components described below.

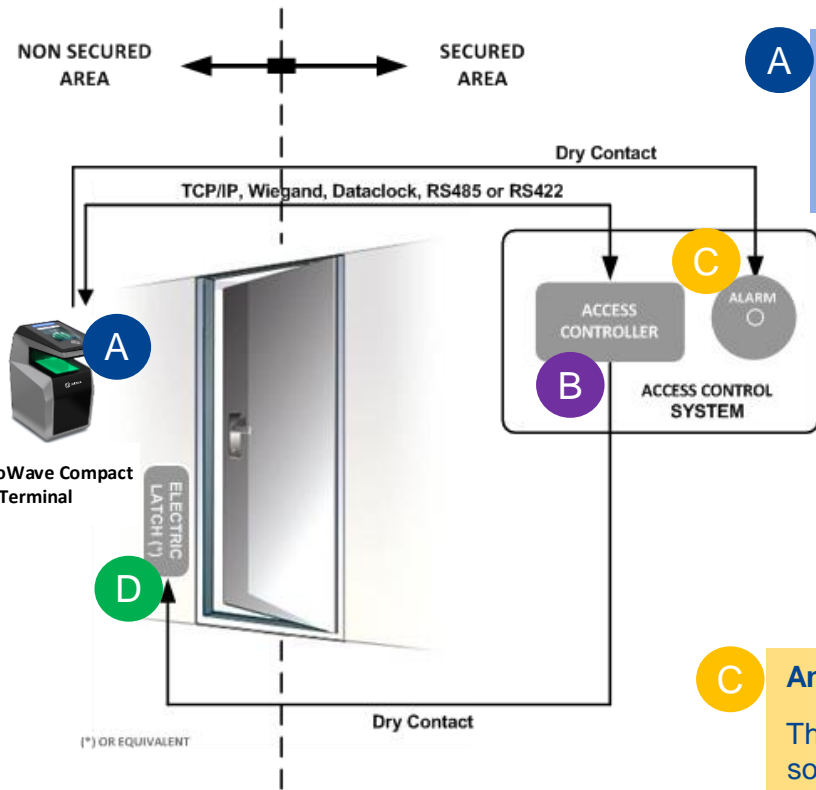

A The MorphoWave Compact terminal

Its role is to process the access request from the user. It performs access right checks using one-to-many biometric identification or one-to-one biometric verification, and/or RF card authentication, and/or PIN check.

B An Access Controller (3rd party product)

The terminal interfaces with an Access Controller (using TCP/IP, Wiegand, Data Clock, RS485 or RS422 protocol):

After access request, the terminal sends the result of user's access rights to the Access Controller (this message contains at least the User ID)

The Access Controller performs additional checks, and returns the final decision (access granted/denied) to the terminal (which displays the result to the user), and to the door controller which opens the door (if the access has been granted).

C An Alarm (3rd party product)

The terminal sends a message to the Access Controller, to activate the Alarm as soon as a malicious activity, such as tamper or pulling, is detected

D A Door Electric Latch or equivalent (3rd party product)

The Access Controller sends a command to activate the latch if the access is granted (i.e. if the individual's User ID is listed in the Controller authorized user List). Control of the latch is made through a dry contact..

Step one : overview

Typical Access Control Process



On Access Request, the terminal checks user's access rights using a biometric check.

If the result of the check is successful (access granted), a message is sent to the Central Access Controller for additional access rights check.

If the user is allowed to access to the protected zone, the central access controller returns an "access granted" message to the terminal and a "open" command to the gate controller.



Note: One user must be enrolled in the terminal database, in order to be able to perform biometric check.

Access Control Modes

The terminal can be configured in one of the modes described in the table below

	Identification	Authentication	Multifactor	Proxy
Access control application	Application that runs on the terminal when it starts.	Application that runs on the terminal when it starts.	Application that runs on the terminal when it starts.	Remote application that controls the terminal through network commands
Access control triggering event	A user swipes his/her hand in the biometric sensor.	A user places a contactless card in front of the reader. (*)	Both Identification and Authentication triggers are enabled.	Triggering events are selected by the remote application
Biometric check (if enabled)	The user's captured fingerprints are matched against all fingerprints in the terminal database.	The user's captured fingerprints are matched against their reference fingerprints. (**)	As per Identification or Authentication, depending on the triggering event	Selected by the remote application
Decision to display result signal to user	By Identification standalone application or controller feedback	By Authentication standalone application or controller feedback	By running standalone application or controller feedback	By remote application

(*) or the user enter their Identifier on the keypad, or a Wiegand frame is received from an external device

(**) stored on the contactless card or in the user record in the terminal's local database

Deployment Environment

Operating temperature	-10°to + 55 °C (14°to 131°F) when ECO-Mode ON -10°to + 45 °C (14°to 113°F) when ECO-Mode OFF
Operating humidity	10 % < RH < 80 % (non condensing)
Storage temperature	-25°to + 70 °C (-13°to 158°F)
Storage humidity	5% < RH < 95 %
IP code	IP65 rated



Do not deactivate ECO-mode when working at a temperature above 45°C (113°F), to avoid overheating.

General precautions

- ◆ Do not expose the terminal to extreme temperatures.
- ◆ When the environment is very dry, avoid synthetic carpeting near the MorphoWave Compact terminal, to reduce the risk of unwanted electrostatic discharge.

Areas containing combustibles

- ◆ Do not install the terminal in the vicinity of gas stations or any other installation containing flammable or combustible gases or materials. The terminal is not designed to be intrinsically safe.

The terminal should be installed in controlled lighting conditions

- ◆ Avoid exposure of the biometric sensor to direct sunlight.

Wiring Overview



Pin numbers shown in this document correspond to the internal connector pinout in the product. The connector attached to the cable is for test only and should be removed for installation.

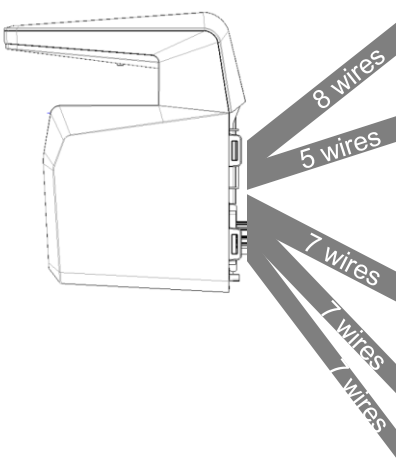

RJ-45 : Ethernet & PoE		
1	ETH TX+	Orange / White
2	ETH TX-	Orange
3	ETH RX+	Green / White
4	ETH VPORT+	Blue
5	ETH VPORT+	Blue / White
6	ETH RX-	Green
7	ETH VPORT-	Brown / White
8	ETH VPORT-	Brown
Shell	ETH GND	Drain wire (no color)

Power supply & Tamper switch		
13	RLY_NC	Orange / White
14	RLY_NO	Yellow / White
12	RLY_COM	Grey / White
5	SWITCH_PIN1	Light Blue
6	SWITCH_PIN2	Pink
1,3	Power + 12V	Red
2,4	Power GND	Black



GPIO		
19	GPI2	Orange / Black
20	GPO2	Yellow / Red
17	GPI1	Orange / Red
18	GPO1	Yellow / Red
15	GPI0	Orange
16	GPO0	Yellow
22	GPIO_GND	Black / Red

RS-422 and 485		
7	RS485_RX_A	Blue / Black
8	RS485_TX_Z	Green / White
9	RS485_RX_B	Blue / White
10	RS485_TX_Y	Green / Black
11	RS485_GND	Black / Red

Wiegand IN & Wiegand OUT		
25	WIEGAND_LEDOUT1	Blue
28	WIEGAND_LEDOUT2	Blue / Red
23	WIEGAND_IN1	White / Red
24	WIEGAND_OUT0	Green
26	WIEGAND_OUT1	White
21	WIEGAND_IN0	Green / Red
27	WIEGAND_GND	Black / Red

All connections of the terminal are of SELV (Safety Electrical Low Voltage) type.



Power supply from electrical source shall be switched off before starting the installation.

Before proceeding, make sure that the person in charge of installation and connections, is properly connected to earth, in order to prevent Electrostatic Discharges (ESD).

Backup of the Date/Time of the terminal: the volatile settings (such as date/time) of the terminal are protected against power failure, by a dedicated component during a least 24 hours (at 25°C) without external power supply.

Step two : wiring

Power supply

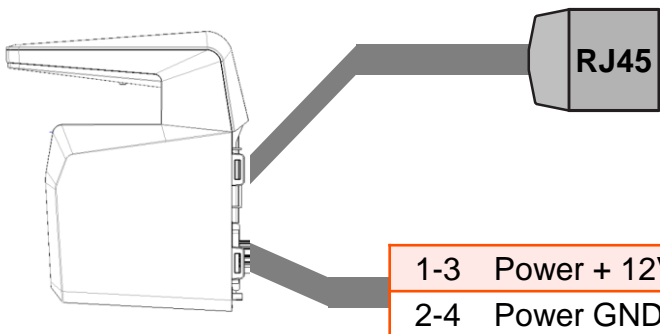

Power Over Ethernet (POE+): power can be provided through RJ-45 connector using a PSE (Power Sourcing Equipment) **IEEE802.3at type 2** compliant.

The terminal is a Class 4 (25.5 W) PD (Powered Device).

PoE+ Injector Specs

- Output Voltage: 48 VDC
- Output Current: 0.64 A
- Power: 30 W

External Power Supply: 12-24 Volts (regulated and filtered) 2.5 Amp min @12 V, CEE/EEC EN60950 standard compliant. If sharing power between devices, each unit must receive 2.5 A (e.g. two units would require a 12 VDC, 5 A supply).

A battery backup or uninterruptured power supply (UPS) with built-in surge protection is recommended.

IDEMIA recommends using a 24V power supply and AWG16 gauge cable. The voltage measured on the product block connector of the terminal must be equal to 12V-24V (-15% / +10%).

The voltage drop due to the cable shall be taken into account. The table at the right, shows the maximum distance between power supply and 1 unique device, depending on cable gauge and power supply rating.

Gauge AWG	Section (mm ²)	Maximum distance (meters) vs power source rating		
		12V +/-10%	12V +/-5%	24V +/-10%
16	1.31	9 m	20 m	300 m
18	0.82	6 m	12 m	200 m
20	0.52	3 m	8 m	120 m
22	0.32	2 m	5 m	75 m



WARNING: Under powering may cause memory and data corruption; over powering may cause hardware damage. Both of these situations will void the warranty

RS-485 Communication

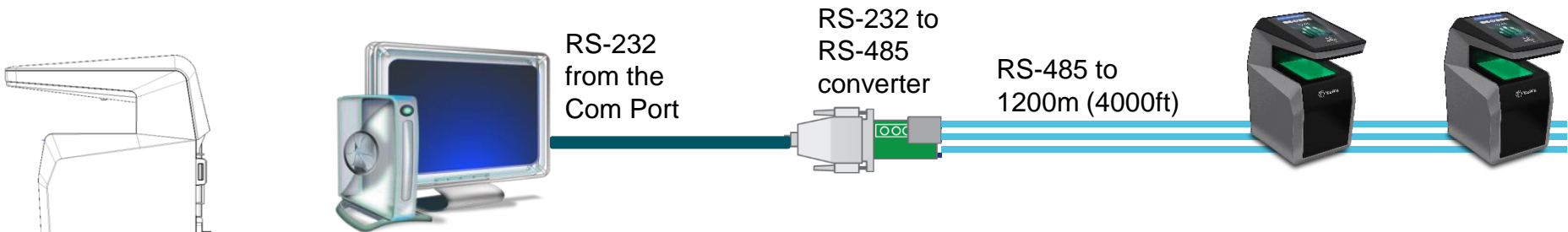

8	RS485_TX_Z (-)	Green / White
10	RS485_TX_Y (+)	Green / Black
11	RS485_GND	Black / Red

For RS-485 installations, the cable should be run in a daisy-chain configuration (i.e. converter > position 1 > position 2 > position 3, etc.).

Choose a RS-232 to RS-485 converter that supports Sense Data to switch from Send to Receive mode.

Use CAT-5 UTP (or better) cable (shielded recommended) with a characteristic impedance of 120 ohms. AWG 24 should be the minimum wire gauge used.

Choose one twisted pair of conductors to use for RS485_TX_Y (TX+, Green / Black wire - 10) and RS485_TX_Z (TX-, Green / White wire - 8). Another conductor should be used for Signal Ground (Black / Red wire - 11).

IMPORTANT:



- > A maximum of 31 devices may be installed on the same line.
- > The maximum total cable length is 4000 ft. (1200m).
- > The cable must be dedicated to this installation and not used for any other purpose

RS-422 Communication

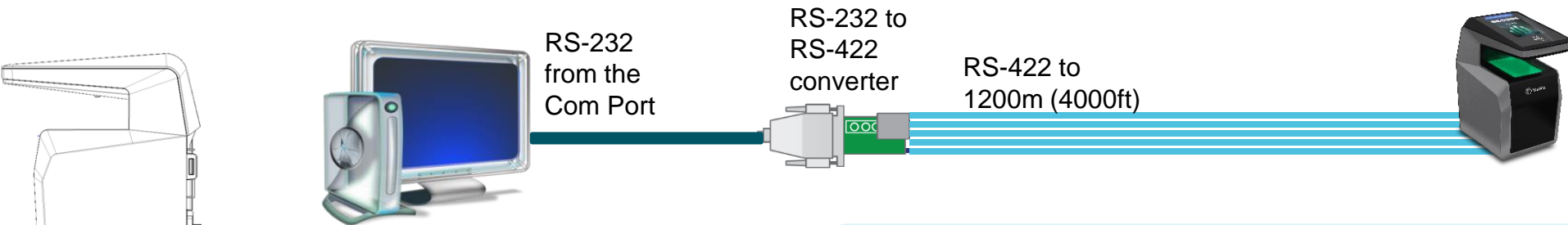

7	RS485_RX_A (RX+)	Blue / Black
8	RS485_TX_Z (TX-)	Green / White
9	RS485_RX_B (RX-)	Blue / White
10	RS485_TX_Y (TX+)	Green / Black
11	RS485_GND	Black / Red

For RS-422 installations, the cable should be run in a point to point configuration (i.e. PC > converter > terminal)

Use CAT-5 UTP (or better) cable (shielded recommended) with a impedance of 120 Ω. AWG 24 should be the minimum wire gauge used.

Choose one twisted pair of conductors to use for RS485_TX_Y (TX+, Green / Black wire - 10) and RS485_TX_Z (TX-, Green / White wire - 8).

Choose one twisted pair of conductors to use for RS485_RX_A (RX+, Blue / Black wire - 7) and RS485_RX_B (RX-, Blue / White wire - 9).

Another conductor should be used for Signal Ground (Black / Red wire - 11).

 The maximum total cable length is 4000 ft. (1200m).
The cable must be dedicated to this installation and not used for any other purpose

Step three : communications

Ethernet and Wireless LAN

1	ETH TX+	Orange / White
2	ETH TX-	Orange
3	ETH RX+	Green / White
4	ETH VPORT+	Blue
5	ETH VPORT+	Blue / White
6	ETH RX-	Green
7	ETH VPORT-	Brown / White
8	ETH VPORT-	Brown
Shell	ETH GND	Drain wire (no color)

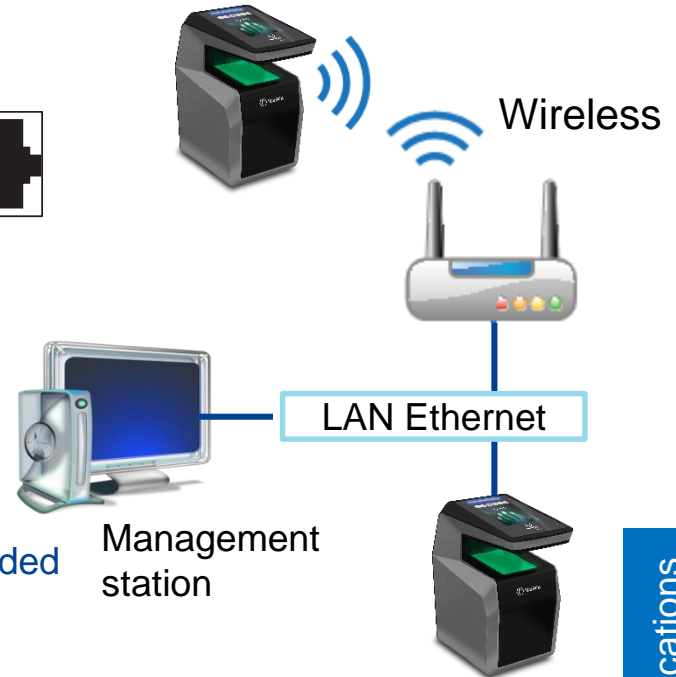
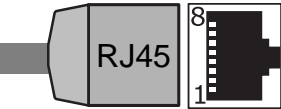

Use a category 6 shielding cable (120 Ohms) or better. It is strongly recommended to insert a repeater unit every 90 m.

Static mode is enabled by default on MorphoWave Compact terminals (factory setting) : IP=192.168.1.10, Gateway=192.168.1.254, Mask= 255.255.254.0

Terminal Block Ethernet connection

- ◆ Extreme care must be taken while connecting Ethernet wire to the block board since low quality connection may strongly impact Ethernet signal sensibility.
- ◆ Connect Rx+ and Rx- with the same twisted-pair wire (and do the same with Tx+/Tx- and the other twisted-pair wire).

WLAN option
 IDEMIA wireless enabled devices support 802.11b and 802.11g standards. WEP Open, WPA and WPA2 are supported.

Step three : communications

Wiegand Communication



Three-conductor cable (shielded recommended) is required for Data 0, Data 1, and WGND.

Use 18-22 AWG cable in a homerun configuration from each unit to the Access Control Panel (ACP).

- ◆ Connect **WIEGAND_OUT0** (Green wire – Pin 24) to ACP Data 0,
- ◆ Connect **WIEGAND_OUT1** (White wire – Pin 26) to ACP Data 1,
- ◆ Connect **WIEGAND_GND** (Black / Red wire – Pin 27) to ACP reader common (0vDC).

For 18 AWG, the maximum cable distance is 500 ft. (150m); for 20 AWG, the maximum is 300 ft. (90m); for 22 AWG, the maximum is 200 ft. (60m).

All controller output shall be open drain or 5 V +/- 5%

Wiegand Communication (continued)

Important

By default, the Wiegand output format is not enabled. Wiegand output must be configured before connecting to the ACP.

Note

On installation, the system administrator will be prompted to select either a pre-existing Wiegand frame format or create a custom format, and upload it to the unit before the first use.

Data Clock

The Wiegand port also supports the Clock & Data protocol. The wiring is described below.

Example Format Information

Type: **Standard 26-bit**

- Alt Site Code and Fail Site Code Range: **0-255**
- Template ID Number Range: **1-65535**
- Extended ID Number Range: **N/A**
- ID Start Bit: 9
- Length of ID: 16
- Site Code Start bit: 1
- Length of Site Code: 8
- Start Bit length : 0

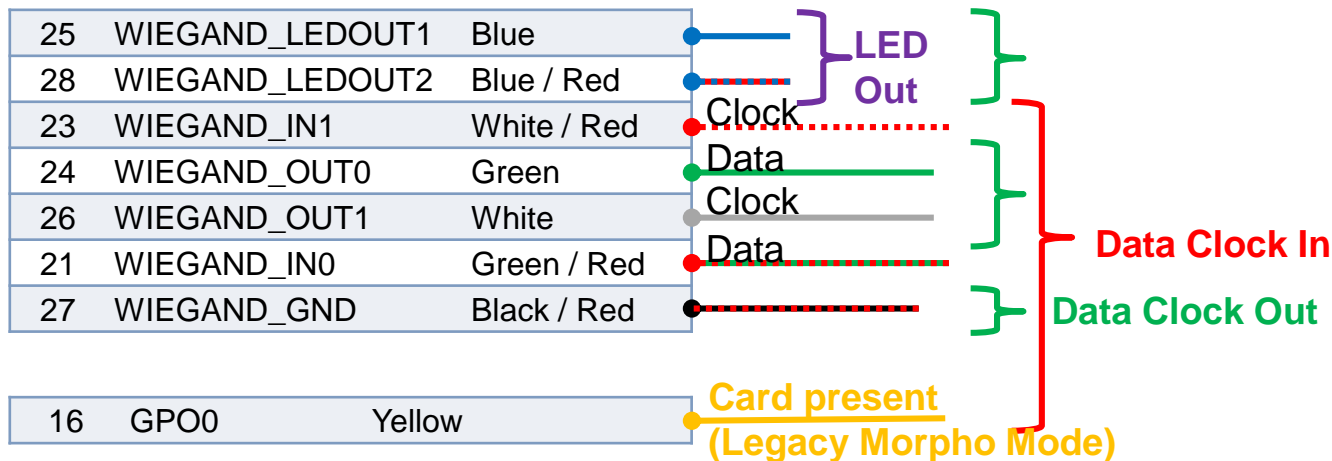

Single Door Access Control (SDAC)

Single Door Access Control (SDAC) wiring sample : with Push Button

See details on next page
for relay connection

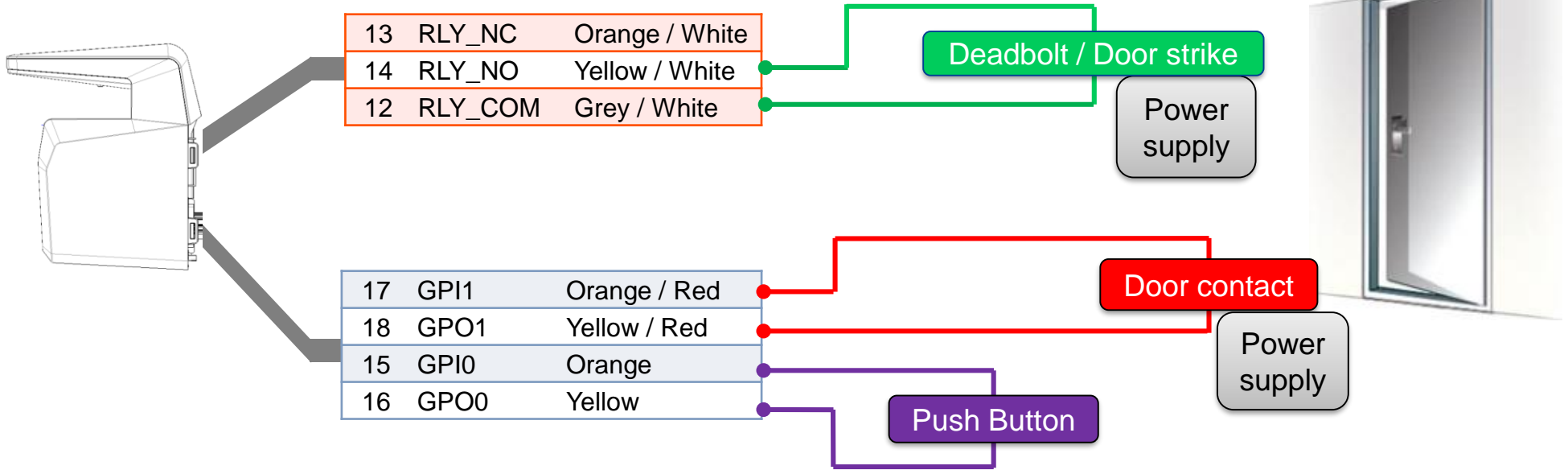

If door contact is not used, GPI1 (17) and GPO1 (18) shall be connected together



Power supply from electrical source shall be switched off before starting the installation.

Internal Relay Wiring

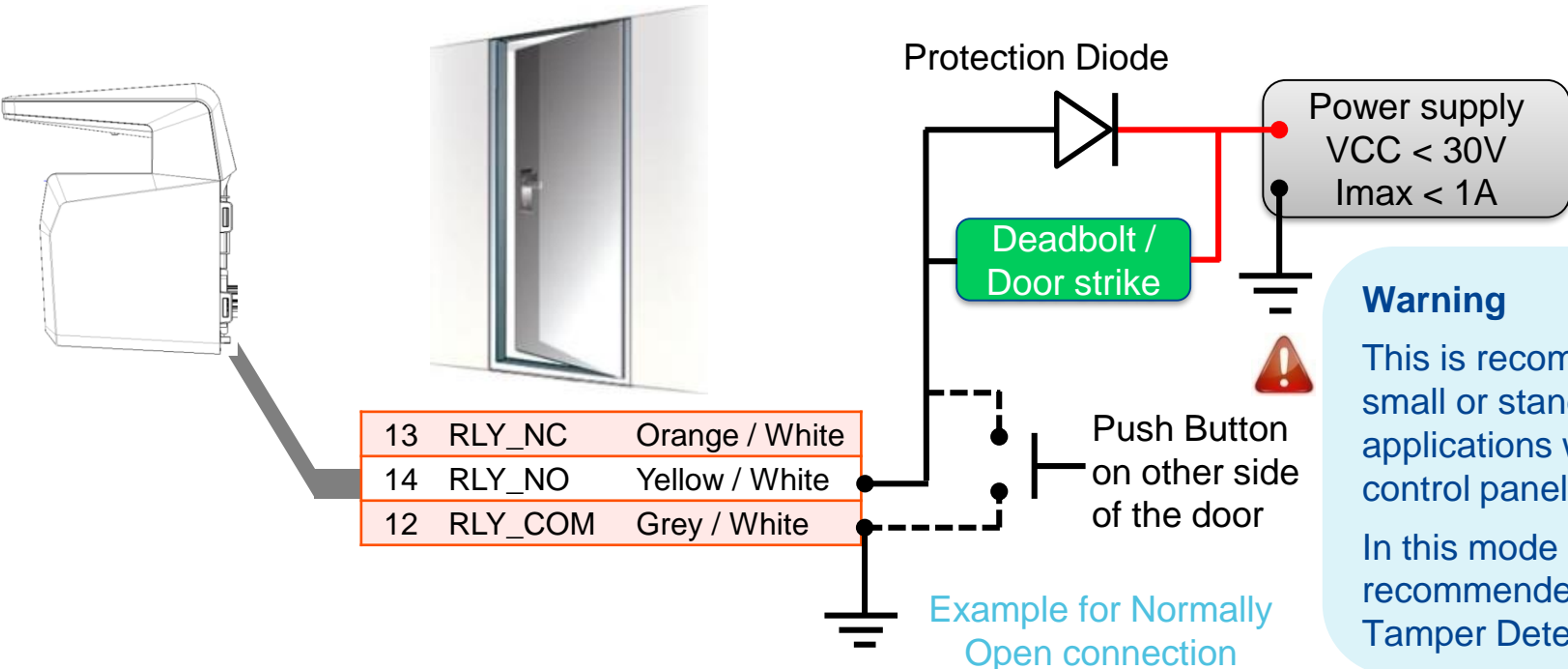

Warning
This is recommended only for small or stand-alone applications where access control panels are not available. In this mode it is strongly recommended to monitor the Tamper Detection of the device

Inductive load management requires a parallel diode for a better contact lifetime.

- Warning**
- The internal relay is limited to a maximum current of 1A @ 30V. If the deadbolt / door strike draws more than 1A, damage to the device may occur. If the deadbolt / door strike load exceeds 1A, an external relay must be used.
 - The internal relay is designed for 100.000 cycles. If more cycles are needed, an external relay driven by GPO must be used.

Step four: SDAC

Local Administration - First Boot Assistant

The First Boot Assistant (FBA) helps the administrator to configure all the device fundamental settings.

It is automatically launched at first terminal startup, but can also be launched on demand, through administration menu (i.e. to reinitialize terminal main settings)

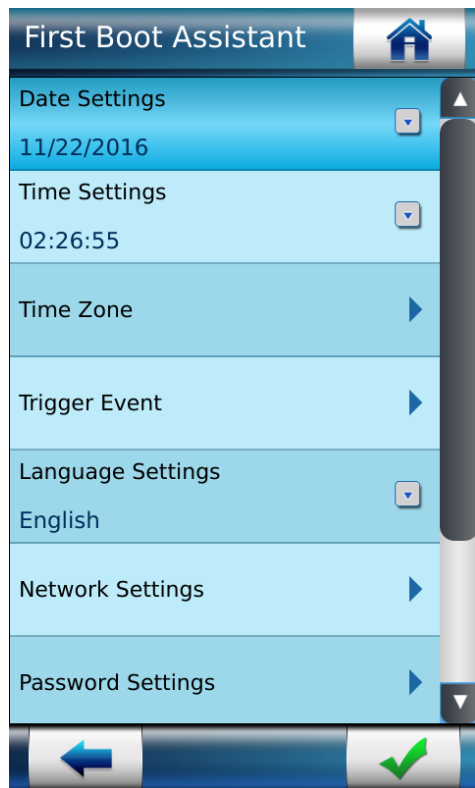

Main settings managed by FBA

Date & Time & Time Zone Settings

Trigger Event: select event(s) to be processed as an access request by a user

Language Settings: user interface language selection,

Network Settings: LAN or WLAN parameters

Password Settings: terminal administration password modification

Boot assistant at next boot: Display this screen on next boot.

Local Administration – Using Touch Screen Menu



Frequently used icons

Back (and Cancel)	Exit or Go Home
Cancel or refuse	Validation or confirmation

+ password (default: 12345)

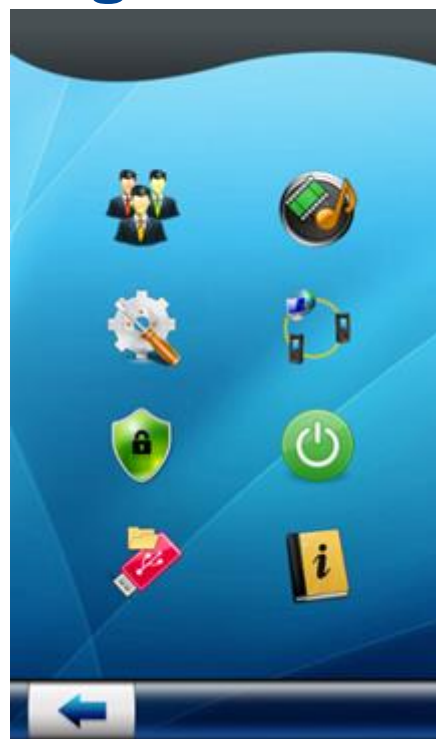

User management	Multimedia management
Terminal settings	Communication settings
Terminal security	Restart terminal
USB key management	Information about terminal



For security reasons, it is highly recommended to change the devices default password to a custom password.

Step five: Administration

Administration with MorphoBioToolBox application

The MorphoWave Compact Series terminal can be configured using a dedicated (Windows) application :

MorphoBioToolBox

Please note that this application has an embedded User Guide (Help menu).

North and South America :

E-mail support.bioterminals@idemia.com with your name, phone number, serial number of your MorphoWave Compact and “**Please Send Link for MBTB**” in the subject of your e-mail. A link to download the software will be e-mailed to you.

Other countries : please contact your sales representative.



Terminal administration with MorphoBioToolBox (MBTB) application

The screenshot shows the MorphoBioToolBox (MBTB) application window. The title bar reads "Terminal administration with MorphoBioToolBox (MBTB) application". The interface includes a menu bar with "File", "Options", and "Help". A sidebar on the left contains icons for various functions. The main area is titled "Connection" and contains a "Terminal Type" dropdown menu set to "MA Sigma". Below this is a "Connection information" section with radio buttons for "TCP / IP" (selected) and "Serial". Under "TCP / IP", there are fields for "Address type" (set to "IP"), "Address" (with a "Sample" watermark), "Port" (set to "11010"), and "Timeout" (set to "10 seconds [5-30]"). There are also checkboxes for "Use SSL / TLS" and fields for "Terminal CA certificate path", "Client certificate path", and "Client certificate password", each with a "Browse" button. At the bottom, there are "Erase logs" and "Export" buttons, and a log window displaying system messages such as "11:34:52 - INFO - Load successful;MBTB.Plugins.RebootFeature".

Step five: Administration

Software for Terminal Remote Administration

MorphoWave Compact Series terminals are fully compatible with:

- ◆ MorphoManager application (version 12 or higher)

Local Enrollment Process 1/2

A new user can easily be added by using the administration menu of the MorphoWave Compact terminal.

This “local enrolment” is recommended only for small or stand alone installations or testing purposes. For professional systems enrolment should be performed remotely with an enrolment station, which is a PC with a dedicated application such as MorphoManager.

This menu allows a user’s record to be added in the local database, with the option of creating a user RF card, with the user’s reference data.

Enrolment gathering user’s data listed :

- ◆ User’s first name and last name
- ◆ User’s fingerprints (for biometric check)
- ◆ User’s administration rights (none, settings, database)
- ◆ User’s PIN (for PIN check)
- ◆ User’s duress fingerprint
- ◆ User’s access schedule and holiday schedule
- ◆ User’s dynamic message setting
- ◆ User’s record expiry date
- ◆ User to include in white list or in VIP list
- ◆ User specific access rules definition

MorphoWave Compact terminal allows you to capture up to 8 fingers per user.

Note: Refer to User enrollment section in MorphoWave Compact Administration Guide.

Enrollment informator

First Name

Last Name

Capture Hands

Administration rights

No Admin rights

User PIN

Job code

Access Schedule

63 : All Access

Step seven: capture basics

Local Enrollment Process 2/2

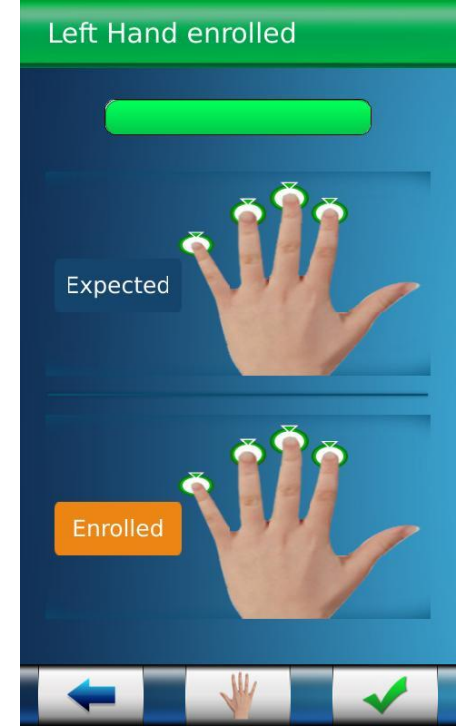
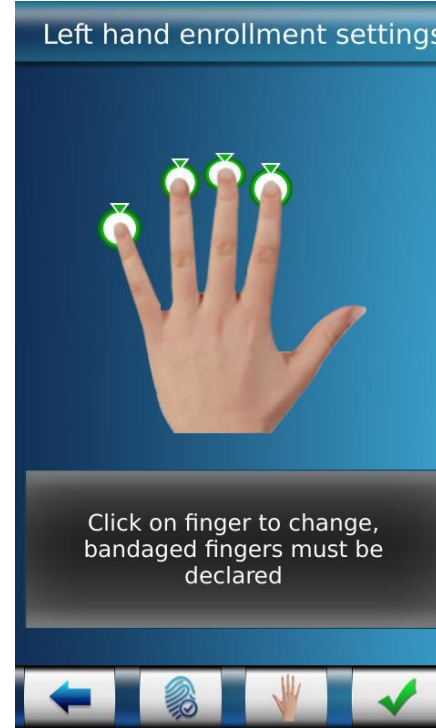
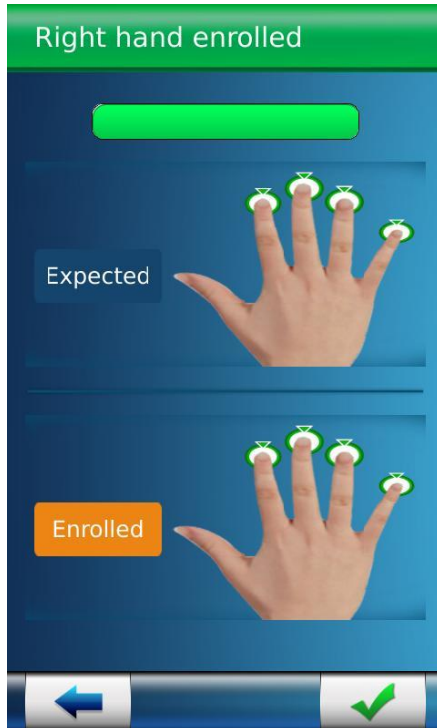
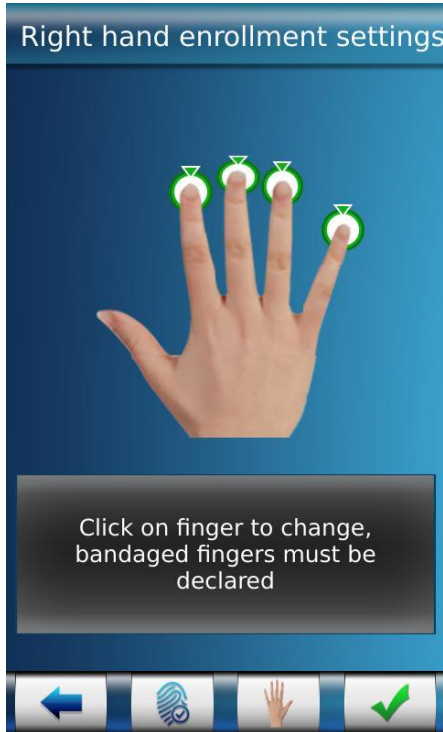

NB: To complete enrollment, two waves are required.

Acquisition guidelines 1/2

Ideal acquisition procedure



1. Insert your hand flat, palm down, from the front of the scanner



2. Slightly spread apart your fingers



3. Place your hand between the cover and the optical sensor



4. Position your fingertips according to the marking on the left/right side of the acquisition area



5. Slide your hand from right to left or left to right

Acquisition guidelines 2/2

Improper use



1. Do not place your hand upside down



2. Do not cross your fingers



7. Do not touch the cover



8. Do not place your hand on the optical sensor



3. Do not place your hand with fingers spread wide



4. Do not place your fingers tightly together



9. Do not place your hand on the edge of the optical sensor



10. Do not place your hand too far up on the optical sensor



5. Do not place 2 hands inside



6. Do not place your hand on the cover



11. Do not tilt your hand (left to right or fingertip to palm)"



12. Do not insert your hand fingers first from either the left or right side of the scanner



13. Do not swipe your hand too fast

Contactless Card Position – PIN input

Contactless Card Position

This action is required once during the user enrolment process (generation / encoding of a user RF card), and at each authentication.

Place user's RF card in front of embedded contactless card reader which is located behind the contactless logo.



The authentication process is initiated by the detection of a user card by the contactless card reader.

The terminal reads the user data stored in the card (at least the User ID), and starts the authentication process, as defined by the terminal settings.

Input PIN



When defined by terminal settings, the user is required to enter his PIN code, once during enrolment process, and at each authentication (in addition or instead of biometric check).

The PIN code is entered using a numeric keypad displayed on the LCD touch screen.

Time and Attendance feature

MorphoWave Compact Series terminals support an optional Time and Attendance (T&A) feature.

For this, the terminal adds a specific T&A information to each identification or authentication record stored in the embedded event log database.

This information is provided by the user through a specific screen displayed during identification or authentication process.

The new screen contains 4 dedicated function keys :

- ◆ Entry
- ◆ Exit
- ◆ Beginning of a task
- ◆ Ending of a task

The user is expected to press one of the keys to provide the specific Time & Attendance information to the terminal.

Depending on terminal settings, this screen is displayed before or after the user waves his/her hand in the sensor or his/her card in front of the reader.

An extended mode is also available with 16 function keys.



Recommendations

The manufacturer cannot be held responsible in case of non-compliance with the following recommendations or incorrect use of the terminal.

Repair and Accessories

- ◆ Do not attempt to repair the *MorphoWave Compact Series* terminal yourself. The manufacturer cannot be held responsible for any damage/accident that may result from attempts to repair components. Any work carried out by non-authorized personnel will void your warranty.
- ◆ Only use the terminal with its original accessories. Attempts to use unapproved accessories with your terminal will void your warranty.

Standalone terminals (not connected to a network)

- ◆ For terminals used in standalone mode, it is strongly recommended to regularly backup the local database, and at least after significant changes in the database (add, remove or modification of user's records), on an external support such as a mass storage key

Date / Time synchronization

- ◆ The *MorphoWave Compact Series* terminal clock has a +/- 10 ppm typical time deviation at +25°C (roughly +/- 1sec per day). At lower and higher temperature, deviation may be greater (maximum : 8 seconds per 48 hours).
- ◆ When the terminal is used for applications requiring high time precision, it is strongly recommended to synchronize the terminal with an external clock.

Cleaning precautions

- ◆ A dry cloth should be used to clean the terminal, especially the biometric sensor.
- ◆ The use of acid liquids, alcohol or abrasive materials is prohibited.
- ◆ Use dry air spray to remove the dust out of the sensor glass

Firmware release

- ◆ To get the best of our technology, we recommend you to download and install the last firmware release (please refer to last page)

Documentation

Documents about installing the terminal

MorphoWave Compact Installation Guide, Ref. 2018_2000035853

This document describes the terminals physical mounting procedure, electrical interfaces and connection procedures.

Documents about administrating / using the terminal

MorphoWave Compact Quick User Guide, Ref. 2018_2000035854

This document gives a quick overview of the product and the basics of configuration and use.

MorphoWave Compact Administration Guide, Ref. TBD

This document describes the different functions available on the terminal and the procedures for configuring the terminal. It also contains the full description of all the configuration parameters for the terminal.

MorphoWave Compact Parameters Guide, Ref. TBD

This document contains the full description of all the terminal configuration parameters.

Documents for the developer

MorphoWave Compact Host System Interface Specification, Ref. TBD

This document describes the commands supported by the MorphoAccess® terminal.

MorphoWave Compact Remote Message Specification, Ref. TBD

This document describes the format of messages sent by the terminal to a distant system.

Release note : for each firmware version, a release note is published describing the new features, the supported products, the potential known issues, the upgrade / downgrade limitations, the recommendations, the potential restrictions...

North and South America: you may obtain these document by e-mailing support.bioterminals@idemia.com with your name, phone number, MorphoWave Compact serial number and “Send Links For MorphoWave Compact Documents” in the subject line.

Other countries: please contact your sales representative.

Contacts

Technical Support and Hotline

North America

Mail: support.bioterminals@idemia.com

Tel: +1 888 940 7477

South America

Mail: support.bioterminals@idemia.com

Tel: +1 714 575 2973

India

Mail: support.bioterminals@idemia.com

Tel: 0120-4699900

South Africa

Mail: support.bioterminals@idemia.com

Tel: + 27 11 286 5855

Europe and rest of the world

Mail: support.bioterminals@idemia.com

Tel: +33 1 30 20 30 40

(9H00am to 5H30pm French Time, Monday to Friday)

For the latest firmware, software, document releases, and news, please check our websites :

- ◆ **North and South America** : e-mailing support.bioterminals@idemia.com with your name, phone number, MA SIGMA Extreme serial number and “Send Links For MorphoWave Compact Documents” in the subject line
- ◆ **Other countries** : please visit our web site www.biometric-terminals.com (To get your log in and password please contact your sales representative).

Copyright © 2018, IDEMIA. All rights reserved.

www.idemia.com

Reproduction in whole or in part in any form or medium without the express written permission of IDEMIA is prohibited.

The trademarks identified herein are the trademarks of registered trademarks of IDEMIA, or other third party.

Gitis Ref TBD

