



ALTAI IX500 Indoor 2x2 802.11ac Wave 2 AP

Quick Setup Guide

Version 1.0

Introduction

Thank you for purchasing the ALTAI IX500 product. This guide provides instructions to install the product and set it up as AP with minimal effort.

Package Contents



IX500 Main Unit

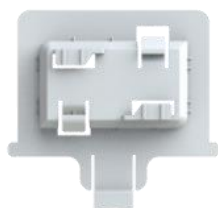

Ceiling Mount Base
(15/16" T-Rail)

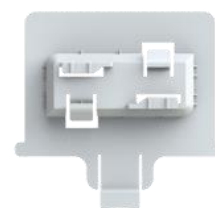

Ceiling Mount Base
(9/16" T-Rail)



Dry Wall Mount Kit

- Anchors x 2
- Screws x 2



Back Cover
(For Indoor Installation)



Quick Setup Guide

Optional Items



Wall/Pole Mount Kit

- Mount Base x 1
- Anchors (For Concrete Wall) x 2
- Screws (For Concrete Wall) x 2
- Cable Tie (For Pole) x 2



Back Cover
(For Outdoor Installation)

Hardware Overview

LED Indicator



Power/Booting Status	<ul style="list-style-type: none"> ○ Off ☀ Flashing Red ● Solid Red 	<ul style="list-style-type: none"> AP Powered Off AP Booting Up AP Boot Up Finished and Ready for Service
2.4G Radio Enabled Only (AP/Station/ Repeater)	<ul style="list-style-type: none"> ● Solid Purple ☀ Alternate Flashing Purple & Red 	<ul style="list-style-type: none"> 1. AP Mode on but with no Client Association; OR 2. Station Mode on but not connected to Remote AP; OR 3. Repeater Mode on but not connected to Remote AP Data Transmitting/Receiving
5G Radio Enabled Only (AP/Station/ Repeater/Bridge)	<ul style="list-style-type: none"> ● Solid Yellow ☀ Alternate Flashing Yellow & Red 	<ul style="list-style-type: none"> 1. AP Mode on but with no Client Association; OR 2. Station Mode on but not connected to Remote AP; OR 3. Repeater Mode on but not connected to Remote AP; OR 4. Bridge Mode on but not connected to Remote Peer Data Transmitting/Receiving
2.4G and 5G Radios Enabled (AP/Station/ Repeater/Bridge)	<ul style="list-style-type: none"> ● Solid White ☀ Alternate Flashing Purple, Yellow & Red 	<ul style="list-style-type: none"> AP/Station/Repeater/Bridge Mode on but with no connection with Client/Remote AP/Remote Peer Data Transmitting/Receiving

Ethernet Port, DC Power Jack and Reset Button

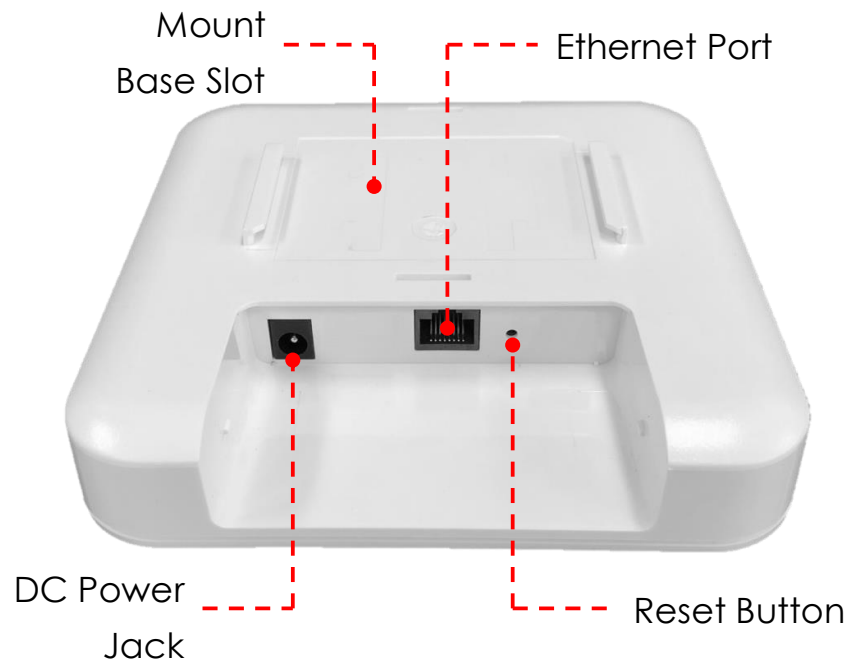

Ethernet Port:

It is used to connect to power source (see the Power Options in the later section) and provides 10/100/1000 Mbps network interface for LAN connection.

DC Power Jack:

It is used to connect to DC power source of 12VDC/1A as another power option.

Reset Button:

It serves two functions:

- **Reboot:** Press and hold the Reset Button for 2-3 seconds until the red LED blinks once.
- **Factory Reset:** Press and hold the Reset Button for 5-8 seconds until the red LED blinks twice consecutively.

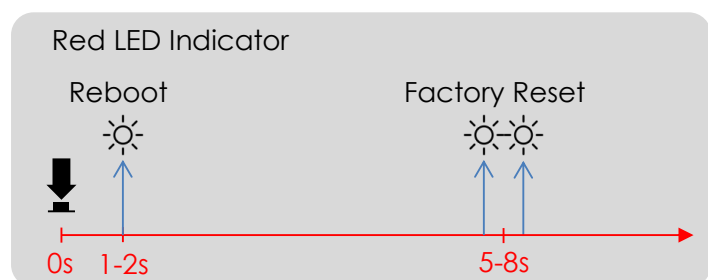

Mounting Options

Option 1: T-Rail Ceiling Mount (9/16" T-Rail OR 15/16" T-Rail)

1

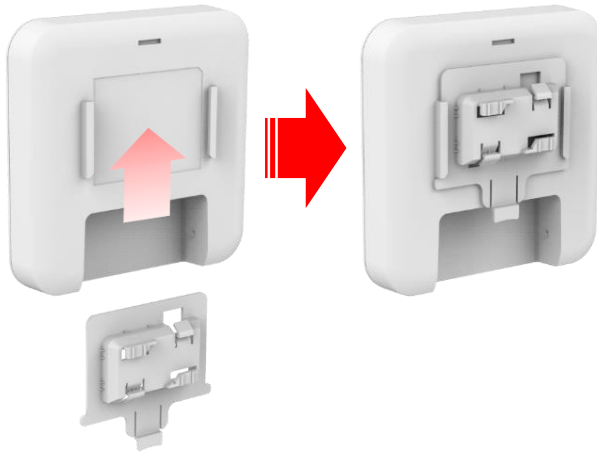

Select an appropriate ceiling mount base (9/16" or 15/16") and slide the base into the slot of the AP.

2

Insert an appropriately sized ceiling rail into one of the mount base slots first. Then turn the AP slightly so that the rail slips into another slot to lock the AP into place.

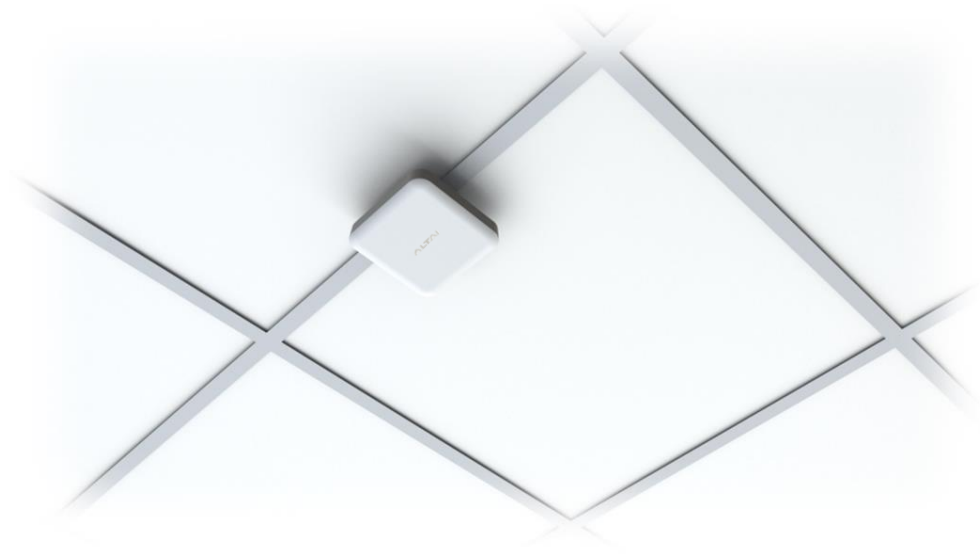
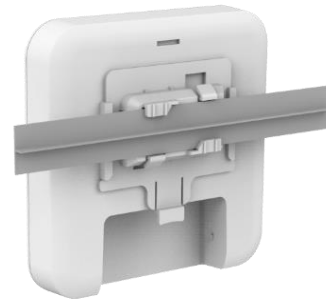

Option 2: Wall Mount (Concrete Wall)

- 1** Determine where the AP is to be placed and mark location on the wall surface for the two mounting holes of the mount base. Use an appropriate drill bit to drill holes of 1/3" (8.1mm) diameter and 1" (26mm) deep. Screw the anchors into the holes and then insert the screws through the mount base to the anchors to attach the base to the wall.

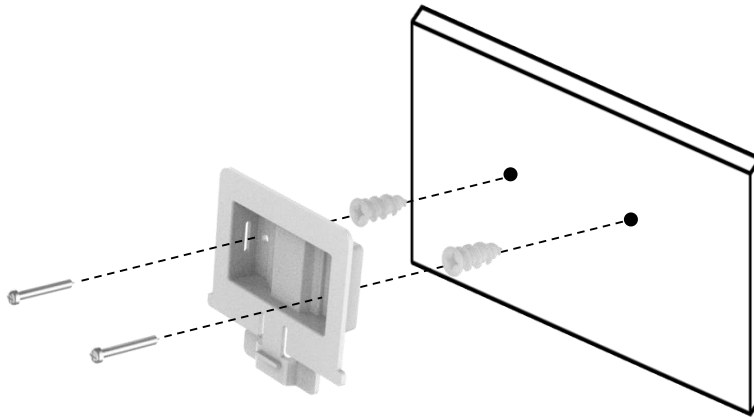

2

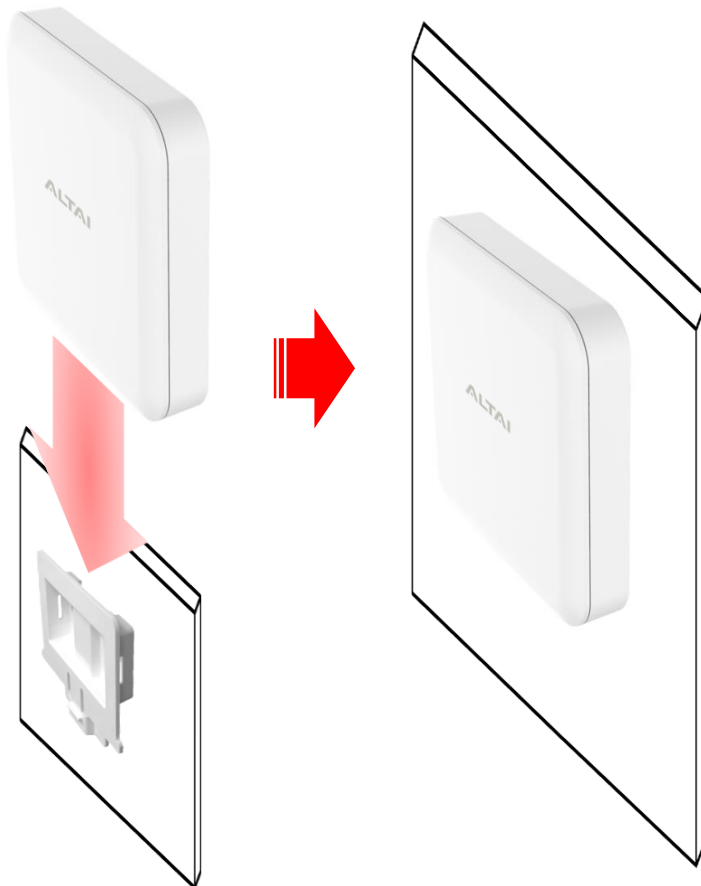

Slide the base into the slot of the AP.

Option 3: Pole Mount (For 1 inch to 3 inches of pole diameter)

1

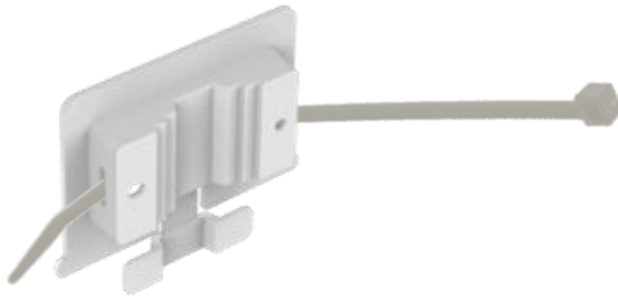

Thread the open end of the cable tie through the two slots of the mount base.

2

Slide the base into the slot of the AP.

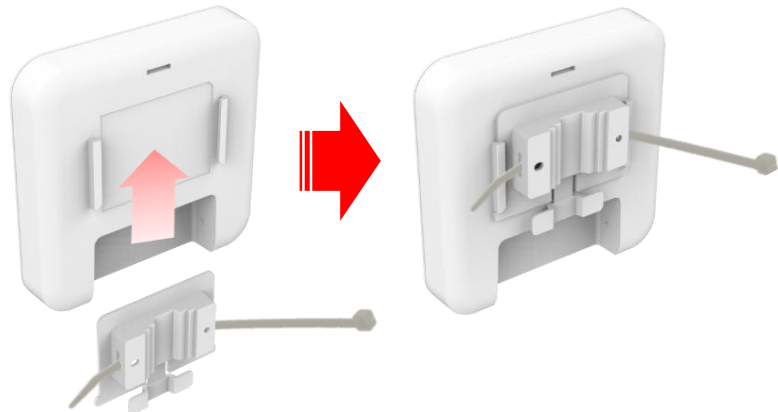

3



Determine where the AP is to be placed. Tighten the cable tie to secure the base to the pole.

Setup Requirements and Preparation

- A computer with Web Browser: Google Chrome, Mozilla Firefox, or Microsoft Internet Explorer 8 (or above)
- Two Cat 5e/6 Ethernet cables
- 802af/at-compliant PoE switch (54Vdc/0.6A)
- AltaiCare account (Optional) for cloud AP management and user service

Power Options and Cable Connection Instructions

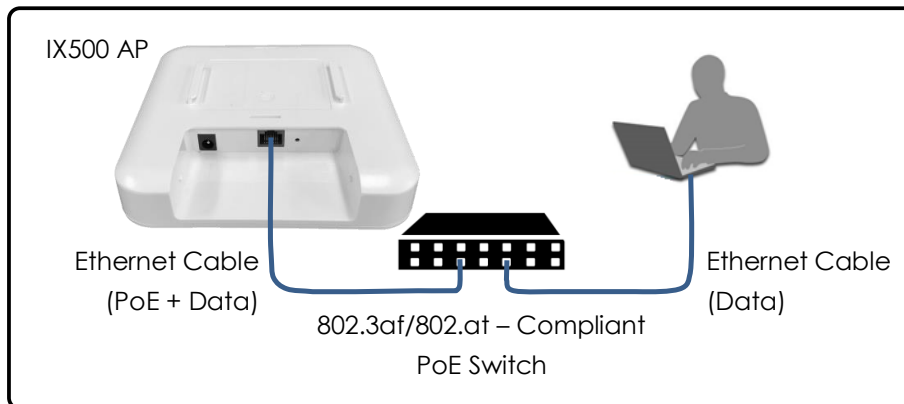

1. Connect the IX500 Ethernet port to an 802.3af/802.at-compliant PoE switch with an Ethernet Cable.
2. Connect a computer to the switch.
3. Make sure the LED indicator turns into a solid light for AP configuration.

1. Change TCP/IP Setting on Your Computer

For Windows 7 users,

1. Go to **Control Panel**, click **Network and Sharing Center** and then choose the adapter that you want to connect to IX500 unit. In this example, adapter "**Local Area Connection**" is in connection with IX500-S. Click it and then click **Properties**.

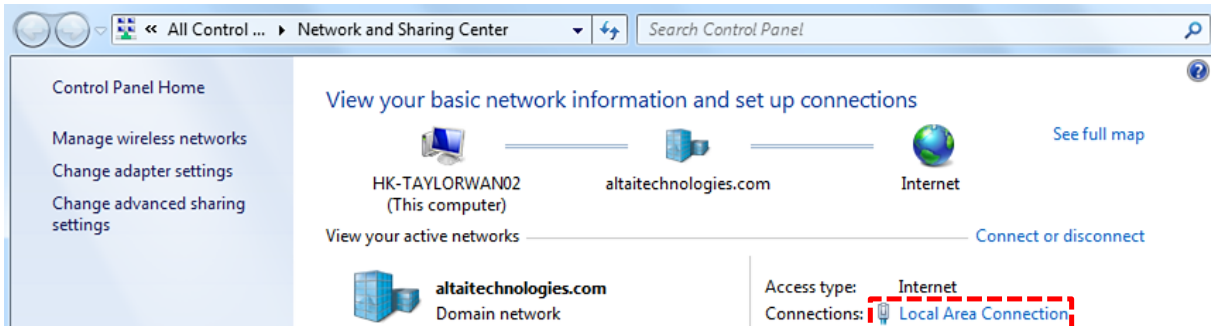

2. Under the **Networking** tab, click **Internet Protocol Version 4 (TCP/IPv4)** in the list box "**This connection uses the following items**", and then click **Properties**.
3. Type in the following IP address and Subnet mask:
 - IP address: 192.168.1.2
 - Subnet mask: 255.255.255.0
4. Click **OK** to close the **Internet Protocol Version 4 (TCP/IP) Properties** dialog box and click **OK** again to close the **Local Area Connection Properties** dialog box.

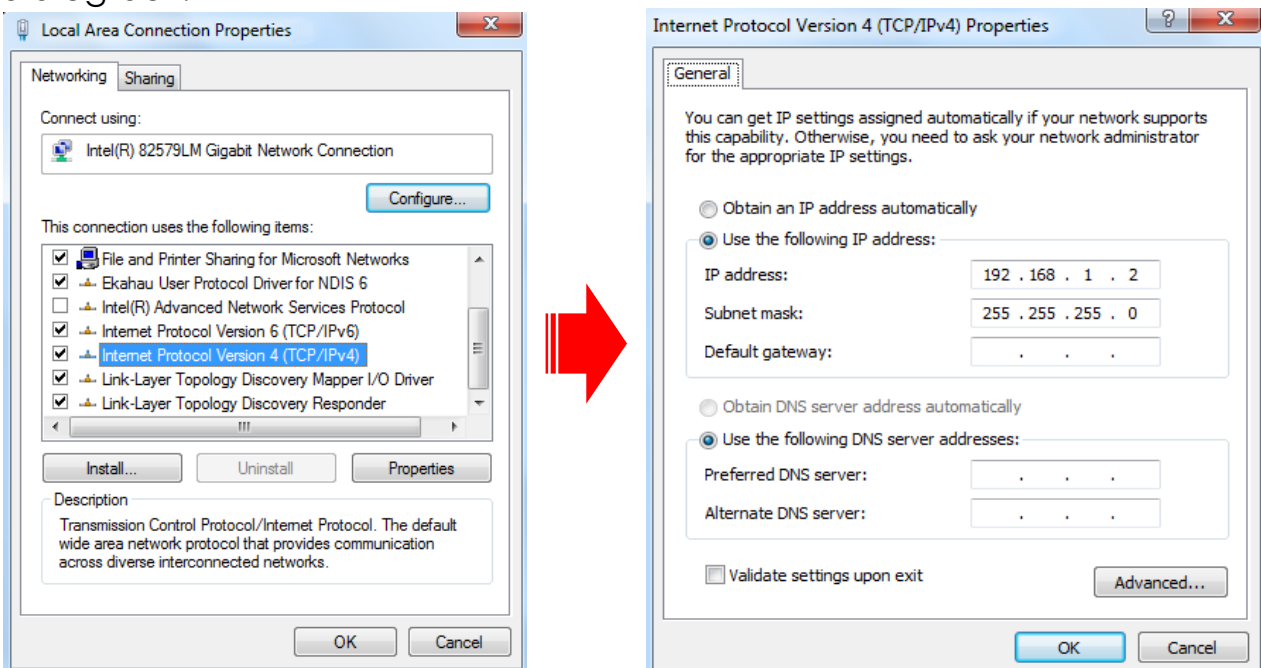

2. Access to Web Interface

1. Open a web browser. Type **192.168.1.222** in the address bar and then hit **Enter**.

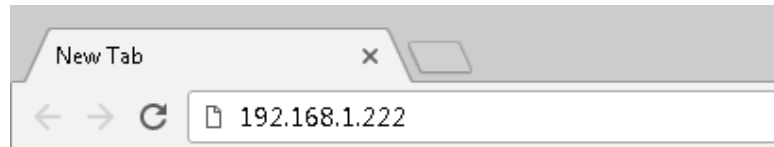

2. Login page will come up and you are required to enter username and password. By default, the credentials are:

- **Username:** admin
- **Password:** admin

3. Click Login.

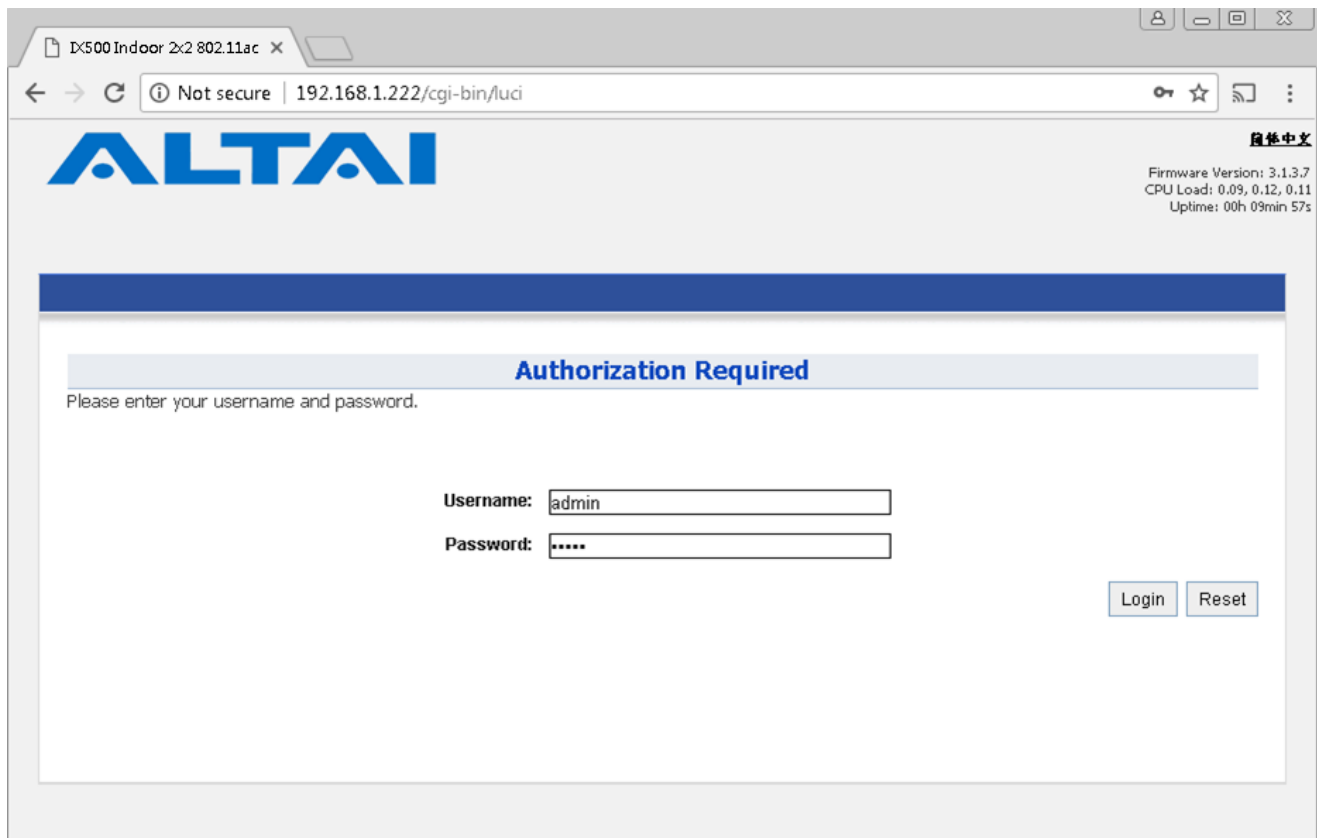

3. Configure AP Mode (2.4G/5G)

Network Scenario

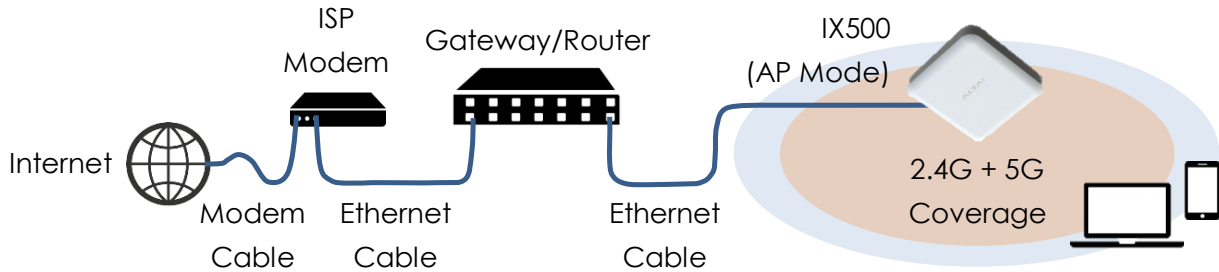

Go to **Configuration > Wireless > Radio0(2.4G)/Radio1(5G) > General**. Below screenshots show an example for 2.4G radio configuration only. Same procedures can be applied to 5G radio configuration.

1. Make sure the box of **Enable Radio** is checked. Select **AP mode** for the field of **Radio Mode**. Then click **Submit**.

The screenshot shows the 'Radio0(2.4G) Setting' page. The 'General' tab is selected. The 'Enable Radio' checkbox is checked. The 'Radio Mode' dropdown menu is set to 'AP'. A red dashed box highlights the 'Enable Radio' checkbox and the 'Radio Mode' dropdown menu.

2. Click **WLAN** and click **More...** in **Detail** of WLAN 0 to go to another page for SSID and security configuration.

The screenshot shows the 'WLAN Configuration' table. The 'More...' link in the 'Detail' column for WLAN 0 is highlighted with a red dashed box.

Enable WLAN	SSID	Max Clients	Isolation	Auth Mode	Access Traffic Right	WLAN Uplink/Downlink Control		Station Uplink/Downlink Control		Detail
<input checked="" type="checkbox"/> 0	Supervifi Networ <input type="checkbox"/> Hide SSID	256	<input checked="" type="checkbox"/>	open	Full Access	0	0	0	0	More...

3. Make sure **WLAN** is enabled by checking the box. Type in **SSID** to name the wireless network you want to broadcast and then click **Submit**.

Radio0(2.4G) WLAN0 Setting

WLAN General | WLAN Security | Portal | Rogue Station List | QoS | Bandwidth Control | Passpoint | Tunnel

Enable WLAN:

Hide SSID:

SSID: Altai IX500

User Isolation:

DHCP Trusted Port:

Enable WiFi Syslog:

Access Traffic Right: Full Access

Max Clients: 256 (1-256)

802.11r FT Roaming:

Mobility Domain ID: 900 (1-65535)

802.11w PMF:

Client SNR Threshold for Association: 0 (0-50 dB)

Back to WLAN List | Submit

4. Click the tab **WLAN Security**. Select **WPA2-PSK** from the drop down menu of **Authentication Mode** and select **AES** for **Cipher Mode**. Type in a password within 8~64 characters or numbers in **Pass Phrase** and click **Submit**.

Radio0(2.4G) WLAN0 Setting

WLAN General | **WLAN Security** | Portal | Rogue Station List | QoS | Bandwidth Control | Passpoint | Submit

WLAN Security Setting

Authentication Mode: WPA2-PSK

Cipher Mode: AES

Group Key Update Interval: 86400 (s)

Pass Phrase: ***** Show
Length:8-63(ASCII Characters); Length:64(HEX Characters)

5. Click **Save & Apply** at the top right corner to have all changes take effect.

6. Hook up the IX500 as shown in Network Scenario. The SSID should now be broadcast from IX500 and can be seen in the computer for wireless connection.

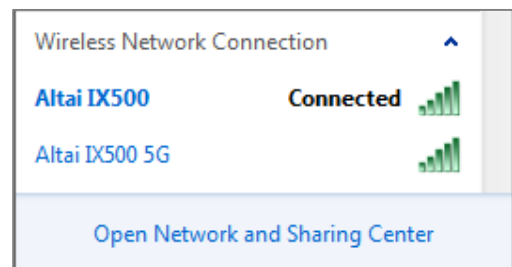

4. Connect with Cloud-Based Controller – AltaiCare

Network Scenario:

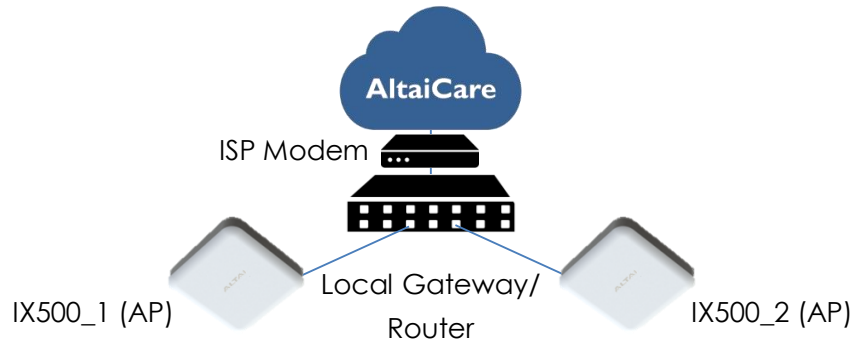

1. You can manage your IX500 and set up hotspot service for the subscribers with AltaiCare, which is a cloud-based system.
2. Go to **Configuration > Network > General**. Select **Switch Mode** for **Network Setting** and make sure the IX500 can reach Internet and communicate with AltaiCare by inputting **valid** IP settings either via DHCP or with Static IP configuration. Google Public DNS Server can be considered, e.g. 8.8.8.8 or 8.8.4.4 if you are not sure about the ISP DNS's Server IP.

The screenshot shows the 'General Network Setting' page in the router's web interface. The page is divided into several sections:

- Network Setting:** Network Setting: Switch Mode (highlighted with a red dashed box). Enable IPv6:
- WAN Setting(IPv4):** Internet Connection Type: Static (highlighted with a red dashed box). IPv4 Address: 192.168.100.30. IPv4 Subnet Mask: 255.255.255.0. IPv4 Default Gateway: 192.168.100.1. IPv4 DNS Server IP Address: 8.8.8.8 (highlighted with a red dashed box). Address: 192.168.100.1
- WAN Setting(IPv6):** Internet Connection Type: Static
- LAN Setting(IPv4):** LAN IP Address: NA. LAN IP Address Mask: NA
- Ethernet Setting:** Table with columns Mode and Speed. eth1: Auto Detect, 100Mbps/Full. eth0: Auto Detect, 100Mbps/Full.
- STP Setting:** Enable STP Mode:

- Click **Remote Mgmt** and check the box of **Enable Remote Management**. Select AltaiCare as **Management Type** and Cloud as **Connection Type**.

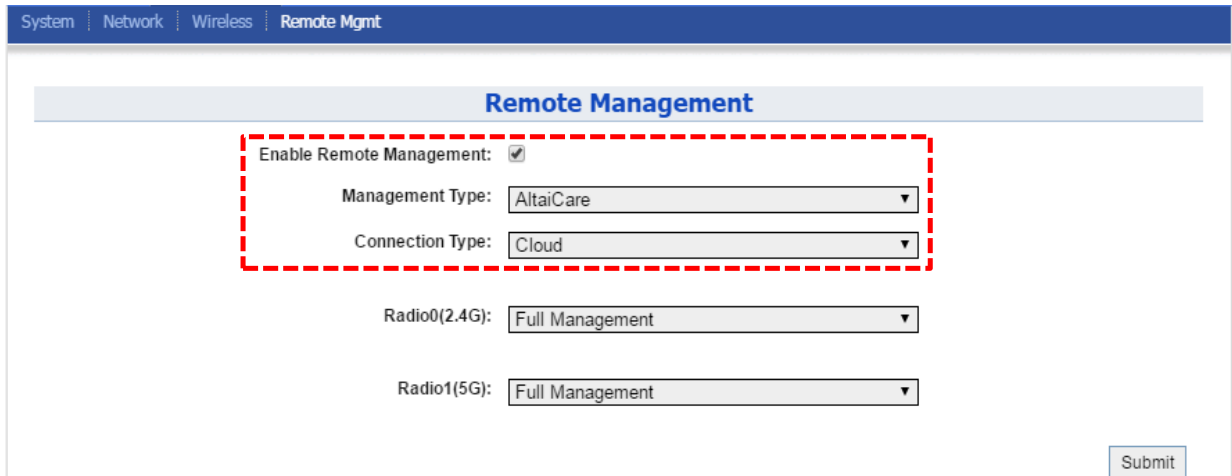

- Select **Full Management** if the device is running in **AP Mode**. For **Station Mode, Bridge Mode** and **Repeater Mode**, select **Monitor Mode** instead.
- Click **Submit** and then **Save & Apply** at the top right corner to make all the changes take effect.
- Follow AltaiCare Quick Start Guide and register the IX500 in the system for AP management and user service and admission control.
- IX500 will appear as online in AltaiCare AP list if the connection is successful.

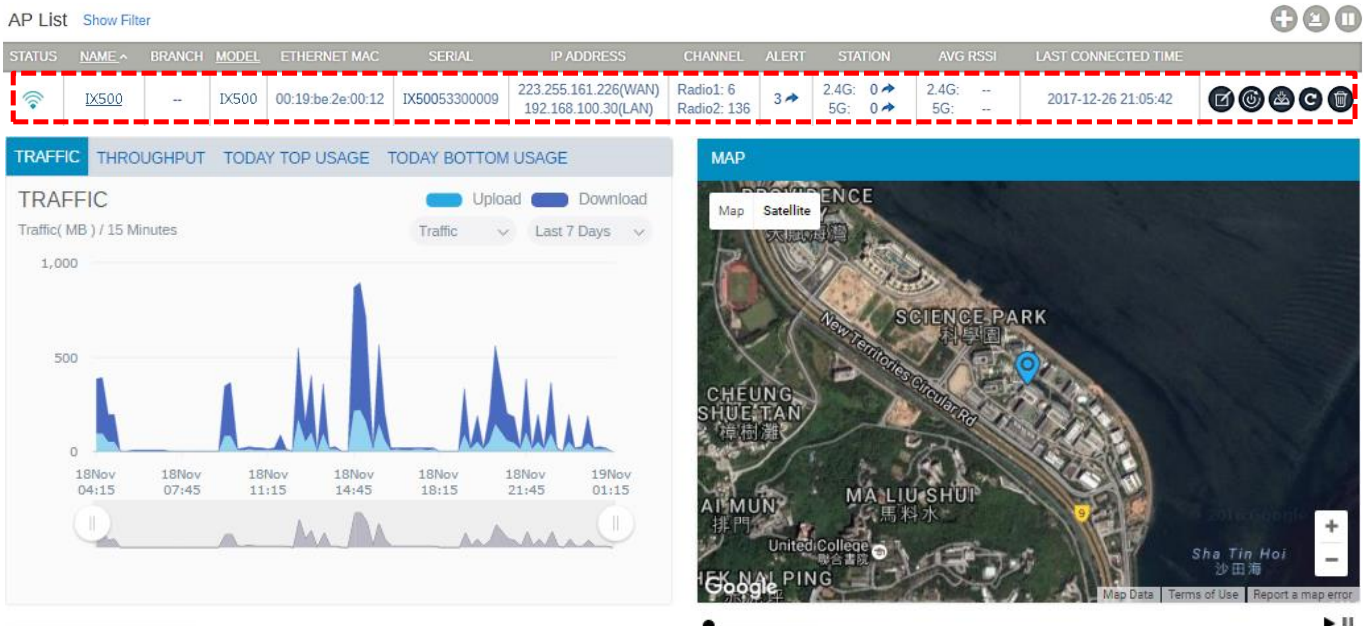

Federal Communication Commission Interference Statement (FCC) – USA

This equipment has been tested and found to comply with the limits for a Class B digital device, pursuant to Part 15 of the FCC Rules. These limits are designed to provide reasonable protection against harmful interference in a residential installation. This equipment generates, uses and can radiate radio frequency energy and, if not installed and used in accordance with the instructions, may cause harmful interference to radio communications. However, there is no guarantee that interference will not occur in a particular installation. If this equipment does cause harmful interference to radio or television reception, which can be determined by turning the equipment off and on, the user is encouraged to try to correct the interference by one of the following measures:

- Reorient or relocate the receiving antenna.
- Increase the separation between the equipment and receiver.
- Connect the equipment into an outlet on a circuit different from that to which the receiver is connected.
- Consult the dealer or an experienced radio/TV technician for help.

FCC Caution: Any changes or modifications not expressly approved by the party responsible for compliance could void the user's authority to operate this equipment.

This device complies with Part 15 of the FCC Rules. Operation is subject to the following two conditions: (1) This device may not cause harmful interference, and (2) this device must accept any interference received, including interference that may cause undesired operation.

IMPORTANT NOTE:

FCC Radiation Exposure Statement:

This equipment complies with FCC radiation exposure limits set forth for an uncontrolled environment. This equipment should be installed and operated with minimum distance 20cm between the radiator & your body.

European Conformity (CE) – EU

This is a Class B product. In a domestic environment, this product may cause radio interference, in which case the user may be required to take adequate measures.



Warning

Only use the power adaptor supplied with IX500. Using a different power adaptor might damage the device.

Disclaimer

All specifications are subject to change without prior notice. Altai Technologies assumes no responsibilities for any inaccuracies in this document or for any obligation to update information in this document. This document is provided for information purposes only. Altai Technologies reserves the right to change, modify, transfer, or otherwise revise this publication without notice.

Copyright © 2018 Altai Technologies Limited

ALL RIGHTS RESERVED.

Altai Technologies Limited

Unit 209, 2/F, Lakeside 2,
10 Science Park West Avenue,
Hong Kong Science Park,
Shatin, New Territories,
Hong Kong

Telephone: +852 3758 6000

Fax: +852 2607 4021

Web: www.altaittechnologies.com

Wong's International USA Corp.

2905 Stender Way, Ste. 52, Santa Clara, CA 95054, USA

Contact person: Mr. Lawrence Tan

Email: lawrence.tan@wihl.us.com

Customer Support Centre:

Email: support@altaittechnologies.com