

Maestro® Dual-Circuit Occupancy Sensing Switch

The Lutron® Maestro® Dual-Circuit Occupancy Sensing Switch combines two switches with an in-wall, passive infrared (PIR) occupancy or partial-on sensor. The sensor is intended for either:

- Control of two circuits
- Bi-level control of two circuits, as required by certain energy codes (e.g., ASHRAE)

Features

- Passive infrared sensor with exclusive Lutron® XCT™ Technology for minor motion detection
- 180° sensor field-of-view
- Tamper-resistant PIR lens
- Up to 30 ft x 30 ft (9 m x 9 m) [900 ft² (81 m²)] major motion coverage and 20 ft x 20 ft (6 m x 6 m) [400 ft² (36 m²)] minor motion coverage
- Smart Ambient Light Detection (ALD) mode uses adaptive algorithm: Sensor learns the user's preferred light level over time.
- Occupancy version can be set to Auto-ON/Auto-OFF or Manual-ON/Auto-OFF
- Meets Title 24/Title 20 requirements for multi-level lighting. Partial-ON only (PPS6-DDV) version available to meet Title 24/Title 20 requirements for Partial-ON sensors.
- Adjustable timeout for each circuit (1, 5, 15, or 30 minutes)
- Sensitivity adjustment (High/Low)
- Switches all lighting loads: incandescent, halogen, ELV, MLV, CFL, LED, magnetic fluorescent, electronic fluorescent.
- Switches fan loads at 120 V~.
- Single-pole only.

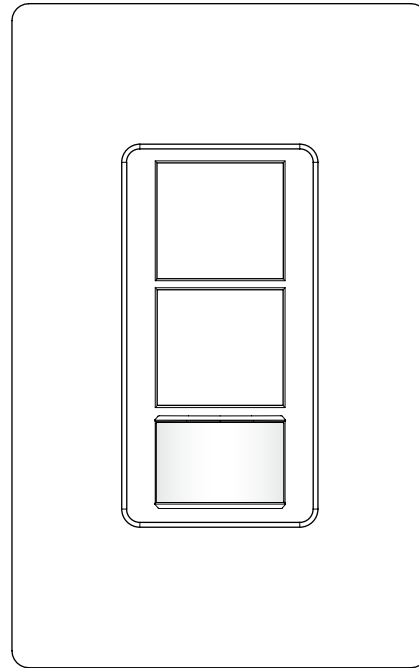

MS-OPS6-DDV-XX¹ (Occupancy model²)
MS-PPS6-DDV-XX¹ (Partial-ON only model²)

- ¹ "XX" in the model number represents color/finish code. See **Colors and Finishes** at end of document.
- ² Wallplate not included

Job Name:	Model Numbers:
Job Number:	

Specifications

Regulatory Approvals

- UL Listed to U.S. and Canadian safety requirements
- Title 20/24 certified lighting control device
 - Complies with Title 20 and Title 24 Section 119 (Until Jan 1st, 2014)
 - Complies with Title 20 and Title 24 Section 110.9 (After Jan 1st, 2014)

Power/Load Control

- 120–277 V \sim 50/60 Hz

Key Design Features

- Switches all lighting loads
- 6 A of lighting load per circuit at 120–277 V \sim
- 4.4 A (1/6 HP) of fan load per circuit at 120 V \sim
- Crush/tamper resistant lens
- Smart Ambient Light Detection (ALD)
- Adaptive zero-cross switching algorithm for extended relay life (patent pending)
- XCT™ Technology for minor motion detection

Environment

- Ambient operating temperature: 32 °F to 104 °F (0 °C to 40 °C), 0%–90% humidity, non-condensing. Indoor use only.

Warranty

- 5-Year Limited Warranty. For additional Warranty information, please visit www.lutron.com/TechnicalDocumentLibrary/Sensor_Warranty.pdf

Additional Information

- For single-circuit Maestro® Occupancy Sensing Switch models, please see Lutron® P/N 369666
- For Maestro® Occupancy Sensor C•L® Dimmer models, please see Lutron® P/N 369748
- For more information, please see www.lutron.com/occvacensors
- Lutron Technical Hotline: 1.800.523.9466.

Advanced Features

Switching

Adaptive zero-cross switching (patent pending)—maximizes relay life by switching at the point of minimum energy on the AC power curve. Actively adapts to variations in relay timing.

XCT™ Technology

Advanced sensing technology for minor motion detection ensures that the lights stay on while the room is occupied, and that the sensor does not turn on falsely when there is no occupancy in the room. For more information, see www.lutron.com/XCTWhitePaper

Job Name: Job Number:	Model Numbers:
--	-----------------------

Custom Settings

(defaults shown in **Bold**)

- **Timeout** (applies to individual circuits)
 - Test mode
 - 1 min
 - 5 min
 - **15 min**
 - 30 min
- **Sensor Modes*** (apply to individual circuits)
 - **Auto-ON/Auto-OFF**¹ (Occupancy mode)
 - **Manual-ON/Auto-OFF**² (Partial-On mode)
- **Advanced Auto-ON Modes** (apply to all Auto-ON circuits)
 - Ambient Light Detection (ALD) mode:
 - Lights turn on only when natural light in the room is low
 - Smart-Ambient light threshold adjusts to the user’s preference
 - **Off-While-Occupied Enabled (OWO)**
 - When the Occupancy Sensing Switch is manually turned off, the Occupancy Sensing Switch will not turn the lights back on automatically while the room is occupied.
 - Once the room is vacated, the Auto-ON feature returns to normal operation after the timeout period has expired.
 - This may be the preference in conference rooms or classrooms while viewing presentations.
 - Off-While-Occupied Disabled
 - When the Occupancy Sensing Switch is manually turned off, the Auto-ON feature will return to normal operation after 25 seconds.
 - When the unit is manually turned off, after 25 seconds the unit will turn back on if motion is detected.
 - This setting may be the preference for high-traffic areas where it is important to ensure that the lights always respond to occupancy (e.g., bathroom, laundry room, utility closet).
- **Sensitivity** (applies to both circuits)
 - **High sensitivity**
 - Low sensitivity
 - Restore ALL defaults

Custom Settings at-a-glance

	Circuit 1	Circuit 2
Timeout	Test mode	Test mode
	1 min	1 min
	5 min	5 min
	15 min	15 min
	30 min	30 min
Sensitivity	High	
	Low	
Sensor Modes*	Auto-ON/Auto-OFF (Occupancy) ¹	Auto-ON/Auto-OFF (Occupancy)
	Manual-ON/Auto-OFF (Partial-ON)	Manual-ON/Auto-OFF (Partial-ON) ²
Advanced Auto-ON Modes	Ambient Light Detection (ALD)	
	Off-While-Occupied Enabled (OWO)	
	Off-While-Occupied Disabled	

* Default settings shown in this section are locked in the MS-PPS6-DDV (Partial-ON only) to satisfy the CEC 2013 Title 24 definition for a “Partial-ON” sensor

¹ Default setting for circuit 1

² Default setting for circuit 2

Job Name: Job Number:	Model Numbers:
--	-----------------------

Load Type and Capacity

Control	Voltage	Load Type	Minimum Load	Maximum Load (Anywhere in Gang)	Neutral Connection Required	Ground Connection Required
MS-OPS6-DDV MS-PPS6-DDV	120 V~	Lighting ^{1, 2}	0 A	6 A per circuit	NO	YES
		Fan ²		4.4 A (1/6 HP) per circuit		
	120-277 V~	Lighting ¹		6 A per circuit		

¹ Occupancy Sensing Switch Load Type: designed for use with permanently installed incandescent, halogen, MLV, ELV, CFL, LED, magnetic fluorescent, and electronic fluorescent lighting loads.

² When controlling light and fan loads simultaneously on a single circuit, maximum load capacity per circuit is 4.4 A at 120 V~.

Job Name:	Model Numbers:
Job Number:	

Occupancy Sensing Switch Placement and Operation



- The ability of the Occupancy Sensing Switch to detect motion requires line-of-sight of room occupants. The Occupancy Sensing Switch must have an unobstructed view of the room.
- Hot objects and moving air currents can affect the performance of the Occupancy Sensing Switch. Switch performs best when located 4 ft (1.2 m) or more away from hot objects or moving air currents.
- The performance of the Occupancy Sensing Switch depends on a temperature differential between the ambient room temperature and that of room occupants. Warmer rooms may reduce the ability of the Occupancy Sensing Switch to detect occupants.

Definitions

Major motion: movement of a person entering or passing through an area.

Minor motion: movement of a person occupying an area and engaging in small activities (e.g., reaching for a telephone, turning the pages of a book, opening a file folder, picking up a coffee cup).

NEMA WD7 Coverage

-  Major motion coverage: 900 ft² (81 m²)
-  Minor motion coverage: 400 ft² (36 m²)

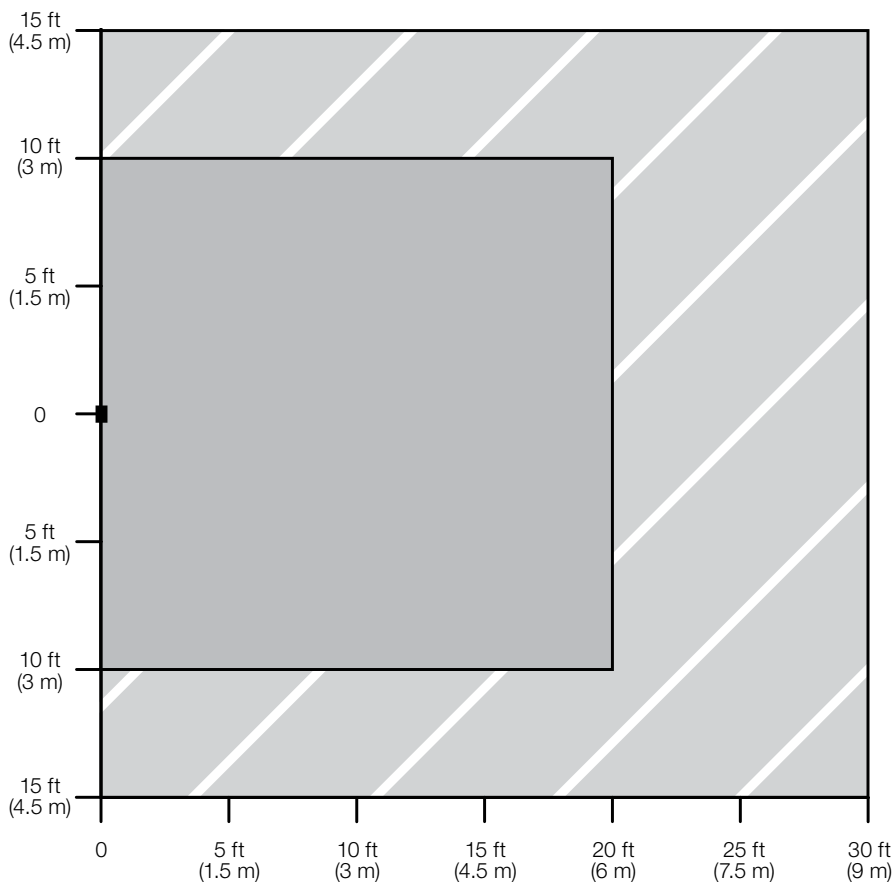

Horizontal Beam Diagram

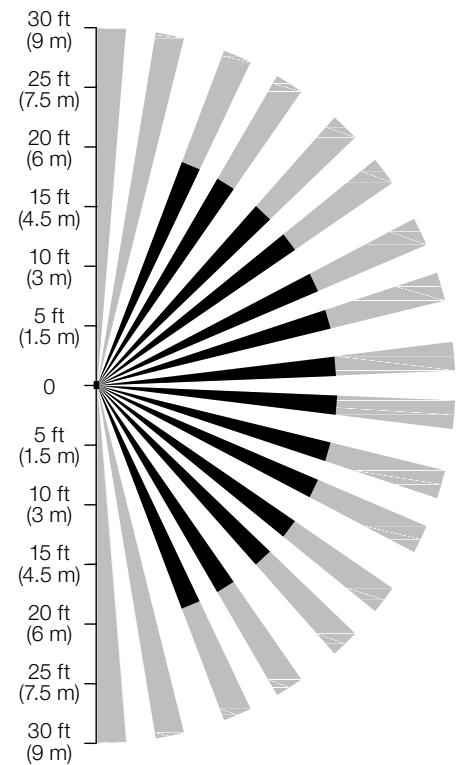

Vertical Beam Diagram

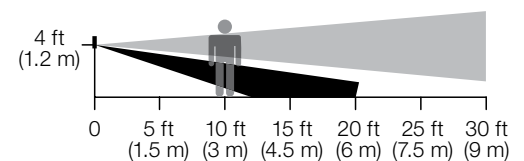

Job Name:	Model Numbers:
Job Number:	

Dimensions

Measurements shown as: in (mm).

Front View

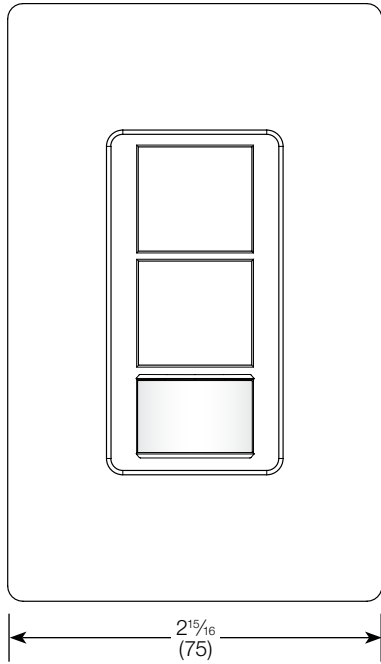

Side View

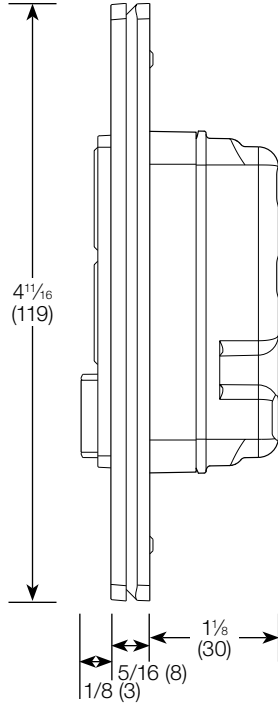

Operation

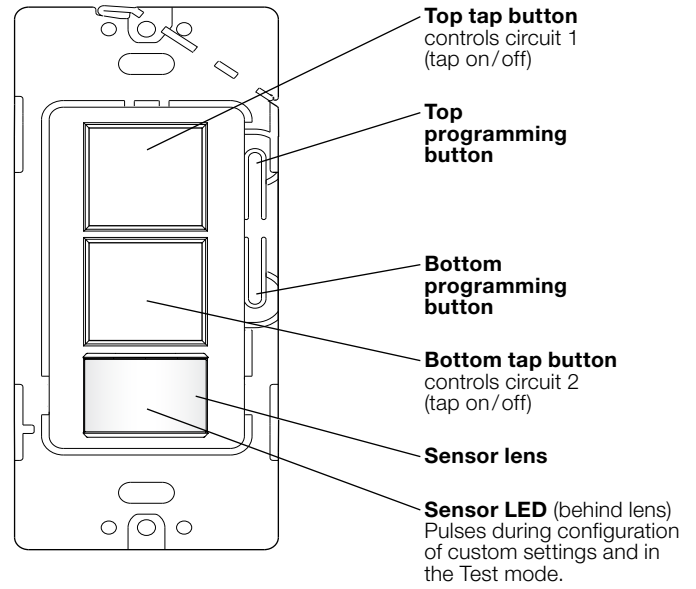

Mounting

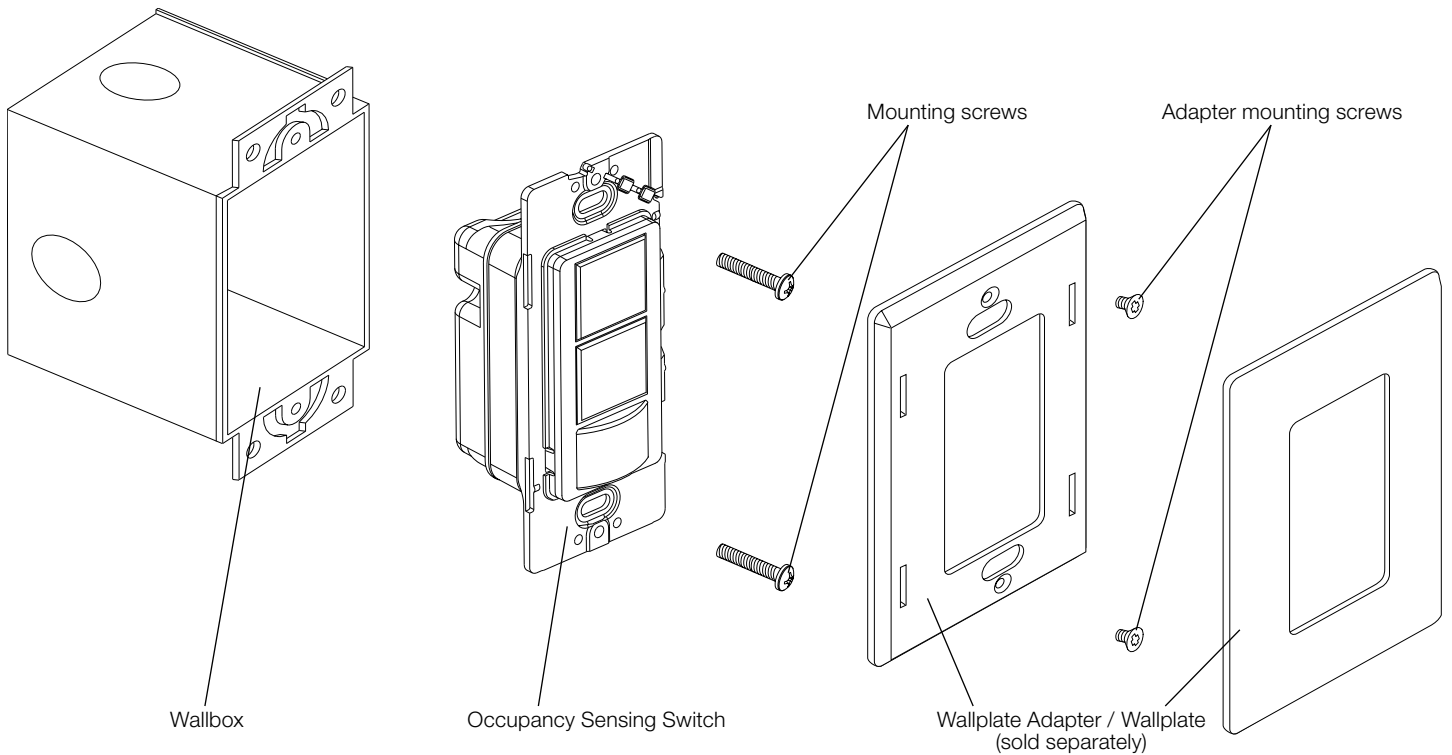

Job Name:	Model Numbers:
Job Number:	

Wiring

Single-Line Wiring

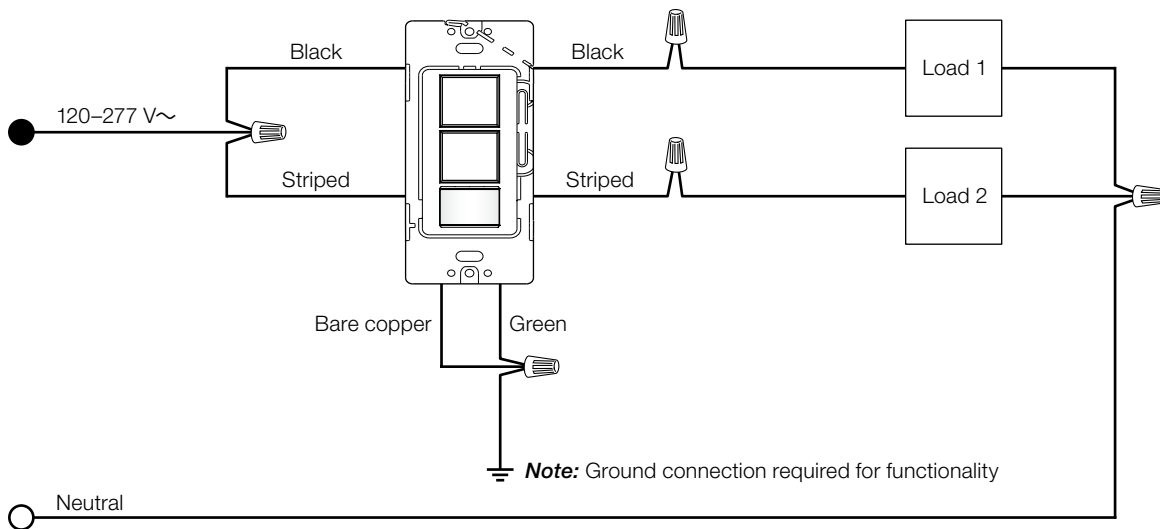

Two-Line Wiring*

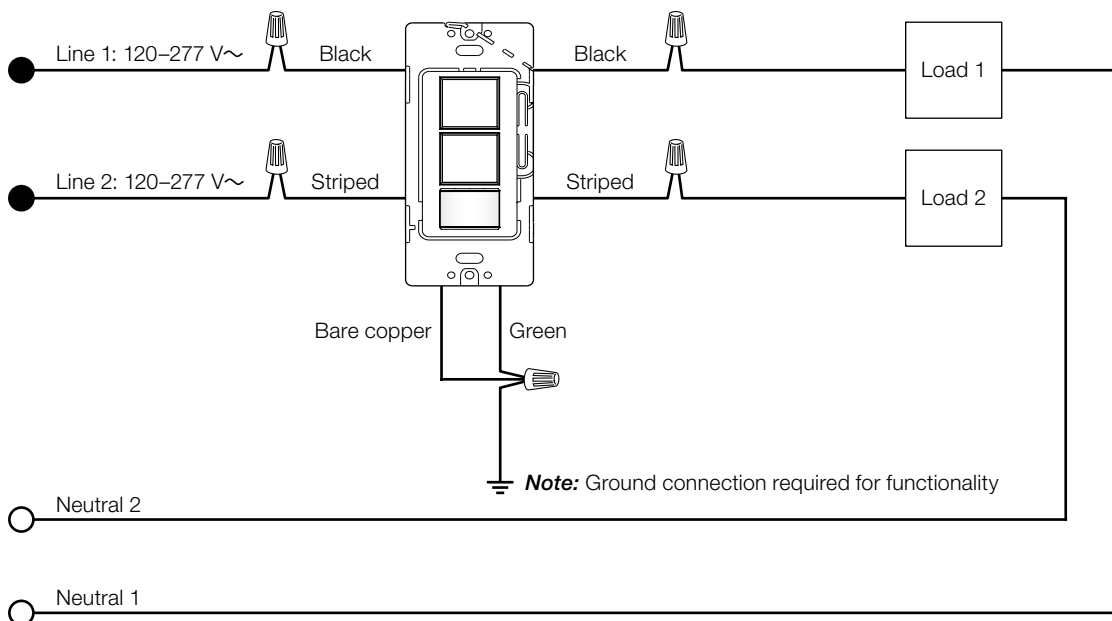

* Wiring must comply with 2011 NEC code 210.7 for wiring Multiple Branch Circuits: Where two or more branch circuits supply devices or equipment on the same yoke, a means to simultaneously disconnect the ungrounded conductors supplying those devices shall be provided at the point at which the branch circuits originate.

Job Name:	Model Numbers:
Job Number:	

Colors and Finishes

Gloss Finishes

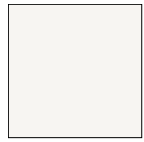

White
WH



Ivory
IV

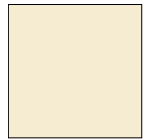

Almond
AL

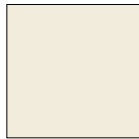

Light Almond
LA

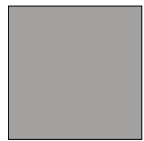

Gray
GR



Brown
BR



Black
BL

Satin Finishes



Hot
HT



Merlot
MR



Plum
PL



Turquoise
TQ



Taupe
TP



Eggshell
ES



Biscuit
BI

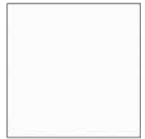

Snow
SW



Palladium
PD



Midnight
MN



Sienna
SI



Terracotta
TC



Greenbriar
GB



Bluestone
BG



Mocha Stone
MS



Goldstone
GS



Desert Stone
DS



Stone
ST



Limestone
LS



Sea Glass
SG

- Due to printing limitations, colors and finishes shown cannot be guaranteed to match actual product colors perfectly.
- Color chip keychains are available for more precise color matching:
Gloss Finishes: DG-CK-1
Satin Finishes: SC-CK-1

<p>Job Name:</p> <p>Job Number:</p>	<p>Model Numbers:</p>
--	------------------------------