

# MEITRACK P88L GPS Personal Tracker User Guide



## Change History



File Name	MEITRACK P88L GPS Personal Tracker User Guide		
Project	P88L	Creation Date	2020-04-05
		Update Date	2021-04-14
Subproject	User Guide	Total Pages	24
Version	V1.2	Confidential	External Documentation

## Contents

1 Copyright and Disclaimer .....	- 4 -
2 Product Introduction .....	- 4 -
2.1 Product Overview .....	- 4 -
2.2 Product Functions .....	- 4 -
2.2.1 Position Tracking .....	- 4 -
2.2.2 Emergency Alert .....	- 4 -
2.2.3 Other Functions .....	- 5 -
2.3 Product Features.....	- 5 -
2.3.1 Man Down Alert.....	- 5 -
2.3.2 Data Usage Saving.....	- 6 -
2.3.3 Alarm Clock.....	- 7 -
2.3.4 Sound and Vibration Settings.....	- 7 -
2.3.5 Step Counting .....	- 8 -
2.3.6 Calling Function of Authorized Phone Numbers .....	- 8 -
2.3.7 Calling Settings.....	- 9 -
2.3.8 WiFi Frequent Stop Place (WiFi Version).....	- 10 -
2.3.9 Assisted WiFi Positioning (WiFi Version) .....	- 11 -
2.3.10 Voice Broadcasting.....	- 12 -
2.3.11 Bluetooth Anti-lost Function (Bluetooth Version).....	- 12 -
2.3.12 Super Deep Sleep Mode .....	- 12 -
2.3.13 Smart Working Mode.....	- 13 -
2.3.14 LED Indicator Settings .....	- 14 -
2.3.15 Setting the Platform Reply Request for the SOS Alert.....	- 14 -
2.4 Product Specifications .....	- 14 -
2.5 Main Device and Accessories.....	- 16 -
2.6 About the P88L .....	- 16 -
2.6.1 Appearance.....	- 16 -
2.6.2 LED Indicator .....	- 18 -
3 First Use .....	- 20 -
4 Device Configuration .....	- 21 -
4.1 Configuring Device Parameters on Your PC .....	- 21 -
4.2 Configuring Device Parameters on Your Phone .....	- 22 -
5 Logging In to MS03 Tracking System.....	- 23 -
6 Safety and Usage Instructions .....	- 23 -
7 Battery Disposal.....	- 24 -

# 1 Copyright and Disclaimer

Copyright © 2021 MEITRACK. All rights reserved.

 ,  and  are trademarks that belong to Meitrack Group and its subsidiary.

The user manual may be changed without notice.

Without prior written consent of Meitrack Group, this user manual, or any part thereof, may not be reproduced for any purpose whatsoever, or transmitted in any form, either electronically or mechanically, including photocopying and recording.

Meitrack Group shall not be liable for direct, indirect, special, incidental, or consequential damages (including but not limited to economic losses, personal injuries, and loss of assets and property) caused by the use, inability, or illegality to use the product or documentation.

## 2 Product Introduction

### 2.1 Product Overview

In addition to the two-way calling, SOS alert in case of emergency, polygonal geo-fence alert and man down alert, the P88L newly developed based on GPS personal trackers MT90 and P99G provides the following new features: voice broadcasting, Bluetooth configuration, pedometer, and alarm clock. The device is a new 4G GPS personal tracker that balances the product size and standby time. It can be used to track the elderly, children, pets, lone workers, and assets in real time.

### 2.2 Product Functions

#### 2.2.1 Position Tracking

- GPS + LBS + WiFi positioning
- Tracking by distance
- Tracking by time interval
- Cornering alert
- Tracking by MS03 app
- Speeding alert
- Bluetooth lost alert

#### 2.2.2 Emergency Alert

- SOS alert

- Man down alert
- Polygonal geo-fence or WiFi geo-fence alert

### 2.2.3 Other Functions

- Configure device parameters by SMS, MS03 platform, Bluetooth or PC
- Step counting
- Voice broadcasting
- Alarm clock
- Fast magnetic charging
- Two-way calling or listen-in
- Support Voice over Long-Term Evolution (VoLTE)
- OTA update
- Select data to be uploaded as required
- Smart power-saving sleep mode
- Smart power-saving working mode

## 2.3 Product Features

### 2.3.1 Man Down Alert

This function is applicable for the elderly and children. When one falls down or asks for help, the device will send a man down alert and the situation will be notified to the designated contact.

You can use any of the following ways to enable the function:

1. Send the command **0000,A29,1,10,1** to the device by SMS.

The A29 command is used to set the man down alert, whose descriptions are as follows.

SMS Sending	0000,A29,Switch,Time,Grade
SMS Reply	IMEI,A29,OK
Description	<p>Switch: Whether to enable the man down alert detection function. The parameter value is <b>0</b> or <b>1</b>. When the parameter value is <b>1</b>, the man down alert detection function is enabled. When the parameter value is <b>0</b>, the man down alert detection function is disabled. The default parameter value is <b>0</b>.</p> <p>Time: Indicates the buzzing and vibration time after the device falls to the ground. During this period, users can press any button of the device to clear the alert, so as to avoid misinformation. If no button is pressed during this period, a man down alert will be generated or the tracker will call the designated contact. Unit: second; value range: 0–255; default</p>

	<p>value: 10.</p> <p>Grade: Indicates the man down alert level. The parameter value ranges from <b>0</b> to <b>3</b> and it is in decimal format. The default parameter value is <b>1</b>. The smaller the value is, the higher the alert probability is.</p>
Applicable Model	MT90/MT90G/P99G/P88L
<b>Example</b>	
SMS Sending	0000,A29,1,10,1
SMS Reply	353358017784062,A29,OK

- On the Meitrack Manager interface, select **Fall**, set a contact's phone number to receive SMS messages and answer phone calls in case of emergency, enable the alert function, and set the alert buzzing time, alert detection sensitivity and motion judgement time after the alert is generated. You are advised to set the three parameters to **10**, **1**, and **0** respectively.

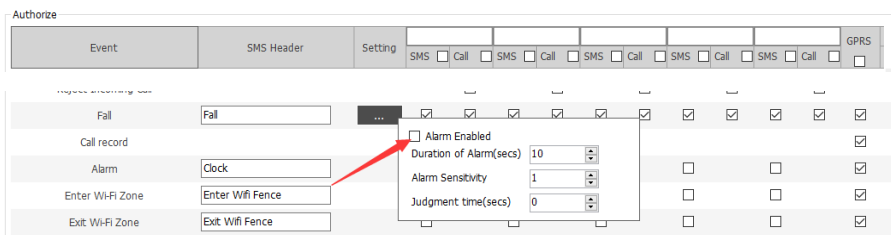

**Note:**

- To avoid misinformation, the device will detect the effectiveness of man down alerts. After the device falls to the ground, if it detects any angle changes and no motion for more than three seconds, it will send a voice warning (or vibrate and make sounds). In this way, users can press any button of the device to clear the man down alert as required. If no button is pressed after the vibration and sounds stop, a man down alert will be generated. (The voice broadcasting function is enabled by default, so the device will not vibrate and make sounds.)
- For details about the A29 command, see the *MEITRACK SMS Protocol*.

### 2.3.2 Data Usage Saving

With the function, users can select data to be uploaded. If the uploaded data occupies too much data usage, users can set data uploading on Meitrack Manager to save data usage. For example, if users want to upload the time, latitude, and longitude only, choose the **Tracking** tab page, select the data to be uploaded, and click **Set**. This operation can save more than 80% of data usage.

Upload Information Select

Select/Unselect all(Except GPS basic information)

<input checked="" type="checkbox"/> Event code	<input checked="" type="checkbox"/> HDOP	<input checked="" type="checkbox"/> First WiFi info	<input checked="" type="checkbox"/> Step count
<input checked="" type="checkbox"/> Latitude	<input checked="" type="checkbox"/> Altitude	<input checked="" type="checkbox"/> Second WiFi info	<input checked="" type="checkbox"/> Wi-Fi Zone info
<input checked="" type="checkbox"/> Longitude	<input checked="" type="checkbox"/> Mileage	<input checked="" type="checkbox"/> Third WiFi info	<input checked="" type="checkbox"/> Alarm info
<input checked="" type="checkbox"/> Date and time	<input checked="" type="checkbox"/> Run time	<input checked="" type="checkbox"/> Fourth WiFi info	<input checked="" type="checkbox"/> Battery Level
<input checked="" type="checkbox"/> GPS positioning status	<input checked="" type="checkbox"/> Base station info	<input checked="" type="checkbox"/> Fifth WiFi info	<input checked="" type="checkbox"/> Current network info
<input checked="" type="checkbox"/> Number of satellites	<input checked="" type="checkbox"/> Input port status	<input checked="" type="checkbox"/> Sixth WiFi info	
<input checked="" type="checkbox"/> GSM signal strength	<input checked="" type="checkbox"/> External power supply voltage	<input checked="" type="checkbox"/> Seventh WiFi info	
<input checked="" type="checkbox"/> Speed	<input checked="" type="checkbox"/> Gen-fence number	<input checked="" type="checkbox"/> Eighth WiFi info	
<input checked="" type="checkbox"/> Driving direction	<input checked="" type="checkbox"/> System flag	<input checked="" type="checkbox"/> Call record	

### 2.3.3 Alarm Clock

Users are allowed to set at most 24 alarm clocks on Meitrack Manager. For example, set an alarm clock for 7:30 am from Monday to Friday. At the preset time point in the SMS time zone, the device vibrates and makes sounds, and an alarm clock alert is sent to the server. During the ringing period, users can press any button of the device to stop ringing.

Multiple alarm clock ringtones are available and users can customize two ringtones according to their habits. The customized ringtones can be downloaded from the FTP to the device by using the B66 or B67 command. The name of the two ringtone files needs to be set to **custom\_1** and **custom\_2**. For more information about the commands, see the *Meitrack P88L GPRS Protocol*.

Alarm Settings

1 2 3 4 5 6 7 8 9 10 11 12 13 14 15 16 17 18 19 20 21 22 23 24

Enable

Day  Sun.  Mon.  Tue.  Wed.  Thu.  Fri.  Sat.

Time

Alarm name  Bell

### 2.3.4 Sound and Vibration Settings

In some specific environments, if users hope that the device vibrates and does not make sounds when an alert is sent, or the device uploads an alert to the platform without vibration and sounds, set the sound and vibration for alerts on Meitrack Manager. For example, if users hope that the device vibrates and does not make sounds when an SOS button is pressed, click **sos\_key**, and then enable the vibration and disable the sound.

Call	<input checked="" type="checkbox"/>	<input checked="" type="checkbox"/>
SOS	<input checked="" type="checkbox"/>	<input checked="" type="checkbox"/>
Side Button	<input checked="" type="checkbox"/>	<input checked="" type="checkbox"/>
Alarm	<input checked="" type="checkbox"/>	<input checked="" type="checkbox"/>
Fall	<input checked="" type="checkbox"/>	<input checked="" type="checkbox"/>
Other	<input checked="" type="checkbox"/>	<input checked="" type="checkbox"/>

### 2.3.5 Step Counting

The device records the number of steps users take every day and uploads those data to the platform as a reference. Daily exercise data can be obtained in real time by the step counting report on the MS03 tracking platform or MP-Safe app. At 00:00:00 (SMS time zone), the steps are cleared automatically.

Note: Users can use the B35 command to set the SMS time zone.

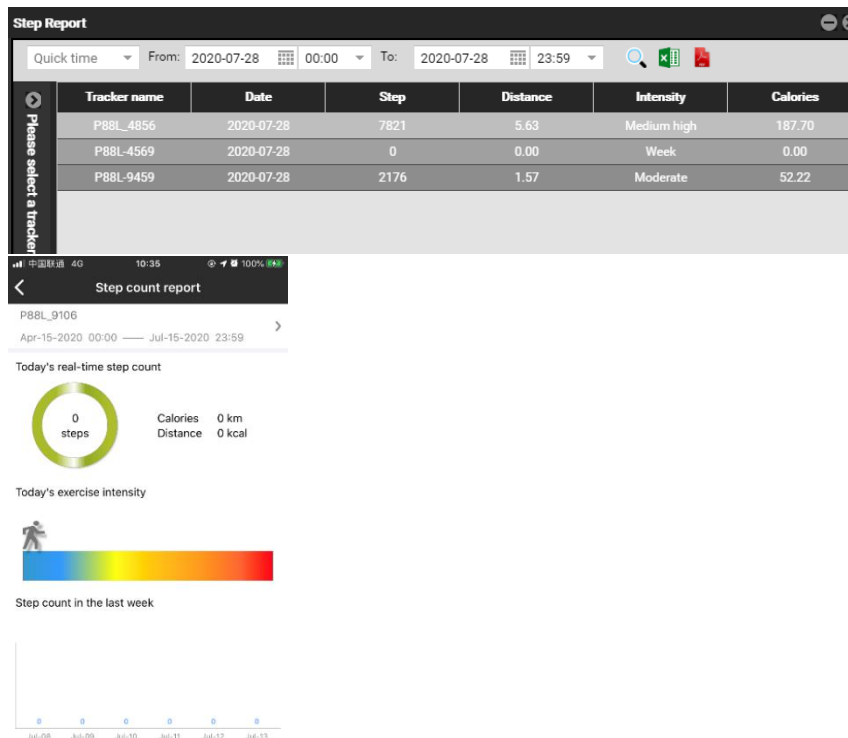

### 2.3.6 Calling Function of Authorized Phone Numbers

Users can authorize phone numbers, which supports the following functions:



- (1) Users can call the device by authorized phone numbers. After a phone call is answered, press 1 to enable the two-way calling function or press 2 to listen in the device.
- (2) When users call the device by authorized phone numbers, the device will answer the phone call automatically. (The auto answer function needs to be enabled in advance.)
- (3) When an alert such as the SOS alert and man down alert is sent, the device will send an SMS message to or dial the authorized phone numbers.

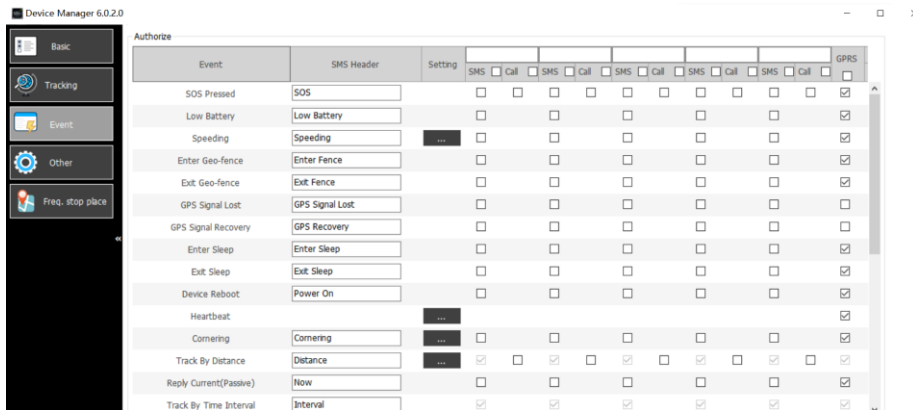

### 2.3.7 Calling Settings

The calling function can be set on the Meitrack Manager software.

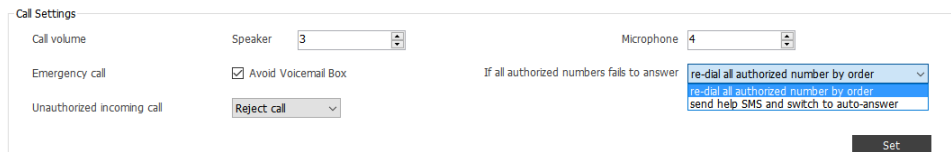

- **Call volume settings:** Users can set the volume of the speaker and microphone.
  - Microphone volume: decimal. The parameter value ranges from 0 to 8. When the parameter value is 0, the microphone is muted.
  - Speaker volume: decimal. The parameter value ranges from 0 to 5. When the parameter value is 0, the speaker is muted.
- **Emergency call**
  - (1) Enable the **Avoid Voicemail Box** function. After five seconds a phone call is answered, the device sends a voice prompt every 15 seconds to the authorized phone number: "Press 1 on your phone to keep the conversation. Otherwise, the call will be disconnected soon." Press 1 on your phone to cancel the voice prompt. If the 1 key is not pressed within one minute, the device determines that this is a voicemail message and the phone conversation

is ended automatically. Then the device dials the next authorized phone number.

Note:

- a) During the dialing, the dialing status is not interrupted after the SOS button is pressed. If the button on the side of the device is pressed, the dialing stops.
  - b) This function is only available for emergency calls when an SOS alert is triggered. For the man down alert and other alerts, the **Avoid Voicemail Box** item can be cleared.
- (2) If no phone call is answered, select one of the following options:
- a) **Re-dial all authorized numbers by order:** The device dials all authorized phone numbers in sequence.
  - b) **Send help SMS and switch to auto-answer:** The device sends an SMS message ("Emergency, please call back soon!") to all authorized phone numbers. Then the device stops auto dialing and the call is answered automatically.

Note: When the call is answered automatically, if an SOS alert is triggered, the device dials all authorized phone numbers in sequence.

- **Incoming call from unauthorized phone numbers**

Users can set **Unauthorized incoming call** to **Reject call** or **Answer call** on Meitrack Manager.

### 2.3.8 WiFi Frequent Stop Place (WiFi Version)

Users can search and record WiFi hotspots nearby and set these WiFi hotspots to frequent stop places on Meitrack Manager. When the device enters a frequent stop place, it detects where the trip starts and ends and then uploads trip starting and ending events.

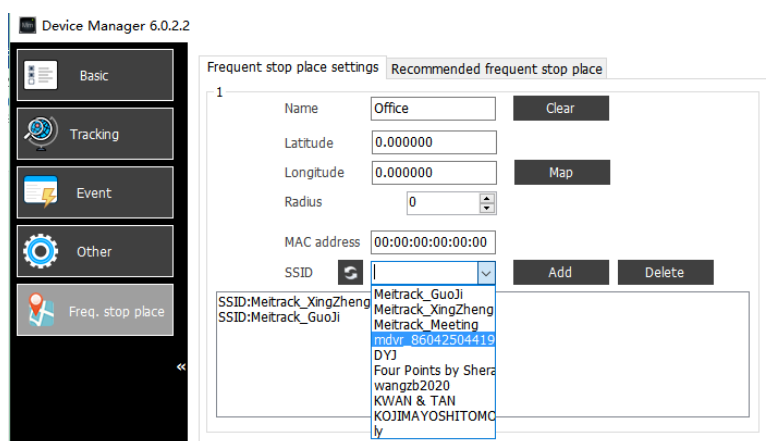

### 2.3.9 Assisted WiFi Positioning (WiFi Version)

The device can automatically search WiFi hotspots nearby and upload WiFi MAC addresses to the platform.

How are WiFi MAC addresses resolved?

(1) The platform will automatically record the MAC addresses uploaded by the device, which means it will record real addresses corresponding to the MAC addresses.

Log in to the MS03 platform by using an advanced account (instead of a general account). To customize the MAC address, enter your account, WiFi MAC address, and geographical location. If this WiFi information is detected by the device, related location is showed on the platform.

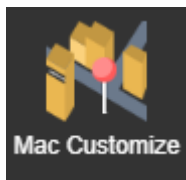

**Add** ✕

User account:

M A C:

Latitude:

Longitude:

Radius:

Address:

**Set in Map**

Distance	Run time	Position	Tracker bat...	Car battery	Ba
1.89km	0Day01:06...	Meitrack_Office_6th_floor_Conference_Room	4.01		75

(2) Resolve uploaded MAC addresses by using the API of third-party databases.

After MAC addresses are resolved, users can know the exact location of the device. Users can use the API of well-known Internet companies, such as Google, to resolve MAC addresses.

### 2.3.10 Voice Broadcasting

When the device falls to the ground or the battery power is low, a voice warning will be sent. (If users want to save power or do not want to hear any sounds, disable the voice broadcasting function on Meitrack Manager.)



### 2.3.11 Bluetooth Anti-lost Function (Bluetooth Version)

The Bluetooth anti-lost function supports Bluetooth anti-lost mode and searching mode. Users can enable the Bluetooth anti-lost function on the MP-SAFE app.

- Bluetooth anti-lost mode: After the device is connected to your phone through Bluetooth, if the unit exits the communication range of the Bluetooth connection (about 10 meters), a Bluetooth lost alert is sent to the platform. If the MP-SAFE app is started on your phone, both the phone and device make sounds and vibrate to remind the users.
- Bluetooth searching mode: After the device is connected to your phone through Bluetooth, if the unit enters the communication range of the Bluetooth connection, users can call and find the device quickly by enabling the Bluetooth searching mode on the MP-SAFE app.

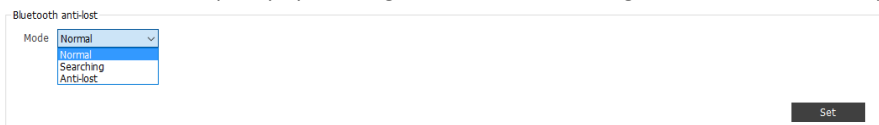

### 2.3.12 Super Deep Sleep Mode

The deep sleep mode is applicable for outdoor workers who want to track their location every several hours or one day and have high requirements of long battery life.

How to enable the function:

1. Enable the super deep sleep mode.
2. Set the heartbeat packet reporting interval (positioning time interval).
3. Set the heartbeat wakeup positioning time (the time of searching GPS signals while positioning).
4. Disable the 3D Shake Wake Up function. (After this function is disabled, the device will not be woken up even if it vibrates. However, the heartbeat packet positioning function will be enabled.)

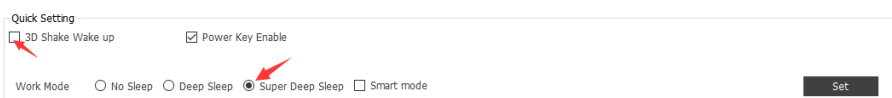

Exit Sleep	Exit Sleep	<input type="checkbox"/>	<input type="checkbox"/>	<input type="checkbox"/>	<input type="checkbox"/>	<input type="checkbox"/>	<input checked="" type="checkbox"/>
Device Reboot	Power On	<input type="checkbox"/>	<input type="checkbox"/>	<input type="checkbox"/>	<input type="checkbox"/>	<input type="checkbox"/>	<input checked="" type="checkbox"/>
Heartbeat	...	<input checked="" type="checkbox"/>	Upload Time Interval(mins)	60	<input type="checkbox"/>	<input type="checkbox"/>	<input checked="" type="checkbox"/>
Cornering	Cornering	<input type="checkbox"/>	<input type="checkbox"/>	<input type="checkbox"/>	<input type="checkbox"/>	<input type="checkbox"/>	<input checked="" type="checkbox"/>
Track By Distance	Distance	<input type="checkbox"/>	<input type="checkbox"/>	<input type="checkbox"/>	<input type="checkbox"/>	<input type="checkbox"/>	<input checked="" type="checkbox"/>

**Tracking Setting**

Protocol: Auto Event Report

GPRS Mode: Mode0      GPRS Report Time: 0

GPRS Interval: 6 X 10 secs      GPS Log Interval(secs): 0

GPRS Interval(Roam): 0 X10 secs      **Heartbeat Location Time(mins): 5**

GPRS Interval(Smart mode): 60 X10 secs

**Set**

**Note:**

1. The heartbeat packet positioning mode is enabled after users set the super deep sleep mode and heartbeat packet wakeup positioning time. The minimum heartbeat packet reporting interval can be set to 10 minutes.
2. In this mode, heartbeat packets may be delayed. After the device is woken up, you need to enable the GPS module first, and then a heartbeat packet can be sent. If the GPS positioning time exceeds the preset heartbeat wakeup positioning time and the GPS is still invalid, an invalid heartbeat packet will be sent. If the GPS is valid, a valid heartbeat packet will be sent. Therefore, the heartbeat packet reporting interval will be affected by GPS positioning time.
3. In sleep mode, the device can be woken up by pressing any button of the device instead of SMS messages or calls.

### 2.3.13 Smart Working Mode

In the smart working mode, the working mode of the device is determined according to users' habits, including the settings of GPS or WiFi frequent stop places and the data tracking time interval.

1. If frequent stop places are set, when the device enters a frequent stop place, it stops data uploading and determines that the trip ends. Then the scheduled tracking event is disabled. When the device leaves the frequent stop place or the SOS button is triggered, the device determines that the trip starts. Then the scheduled tracking event is enabled. If no frequent stop places are set, no trip ending events will be generated.
2. When the data tracking time interval is less than or equal to five minutes, the GPS module always works. When the data tracking time interval is greater than five minutes, the GPS module may work or not. In this way, the device will determine whether it continues to work or enters the sleep mode based on users' behaviors, so as to save battery power. But the condition is that this action cannot affect the device's travel routes. After the smart working mode is enabled, the

heartbeat packet and deep sleep functions will be unavailable.

**Quick Setting**

3D Shake Wake up     Power Key Enable

Work Mode     No Sleep     Deep Sleep     Super Deep Sleep     Smart mode

**Set**

---

**Tracking Setting**

Protocol: Auto Event Report

GPRS Mode: Mode2    GPRS Report Time: 0

GPRS Interval: 6 X 10 secs    GPS Log Interval(secs): 0

GPRS Interval(Roam): 0 X 10 secs    Heartbeat Location Time(mins): 5

GPRS Interval(Smart mode): 60 X 10 secs

**Set**

### 2.3.14 LED Indicator Settings

The device's LED indicators can be set to **On**, **Off**, or **Power saving mode**.

Power saving mode: In any working mode, if the device operates for more than three minutes, its LED indicators are turned off. Users can press any button of the device to turn on LED indicators. (LED indicators cannot be turned on by device vibration.)

**LED indicator Setting**

Mode     On     Off     Power save mode

**Set**

### 2.3.15 Setting the Platform Reply Request for the SOS Alert

Users can set the platform reply request for the SOS alert.

If the platform reply request is enabled and an SOS alert is triggered, the device's buzzer makes sounds to notify users that the server has received the SOS alert after the device receives a message about the reply confirmed by the platform.

If the platform reply request is not enabled and an SOS alert is triggered, the device's buzzer makes sounds to notify users of the SOS alert immediately.

**Request platform reply**

SOS     Enable

**Set**

## 2.4 Product Specifications

Item	Specifications
Dimension	67.8 mm x 44.4 mm x 16.3 mm
Weight	60g
Frequency band	<b>P88L-E:</b> 2G GSM: B3/B8 3G WCDMA: B1/B8 4G FDD: B1/B3/B7/B8/B20

	<p><b>P88L-A:</b> 3G WCDMA: B2/B5 4G FDD: B2/B4/B12</p> <p><b>P88L-SA:</b> 3G WCDMA: B1/B5 4G FDD: B1/B3/B5/B7/B8/B28</p> <p><b>P88L-JE:</b> 4G FDD: B1/B3/B8</p> <p><b>P88L-JC:</b> 4G FDD: B1/B18/B19/B26</p>
WiFi positioning (optional)	WiFi@2.4 GHz 802.11 b/g/n
Bluetooth (optional)	BLE 2.4G. Configure device parameters by Bluetooth. Support the Bluetooth anti-lost function.
GPS positioning accuracy	2.5 meters
Water-resistance rating	IP67 (Withstand being submerged in water for up to 30 minutes in a 1-meter depth)
Operating temperature	-10°C to 65°C
Operating humidity	5%–95%
Power input	DC 5 V/2 A
SIM card	Nano SIM card. Before installing the card, users need to remove the outer case of the device.
Memory	8 MB
Sensor	3-axis accelerometer
Reminder function	Built-in buzzer and vibration motor
Microphone/Speaker	Internal microphone and speaker
LED indicator	Green, blue, and red LED indicators showing the GSM, GPS, and power status respectively
Battery capacity	1000 mAh/3.7 V
Battery power consumption (normal)	60 mA (2G; 3.8 V; GPS on; preset time interval: 60 minutes; WiFi on; average current)
Battery power consumption (standby)	5 mA (average current; 3.8 V; GPS off or WiFi off; don't upload data) 200 hours of battery hours
Charging	Fast magnetic charging (standard): 1800 mA (charging time: about 1.5 hours)

Button/Switch	1 SOS button (used for sending SMS/GPRS alerts and calling) 1 switch on the side
---------------	---

## 2.5 Main Device and Accessories

- P88L tracker
- Magnetic USB cable
- Charger
- CD download card
- Lanyard

## 2.6 About the P88L

### 2.6.1 Appearance

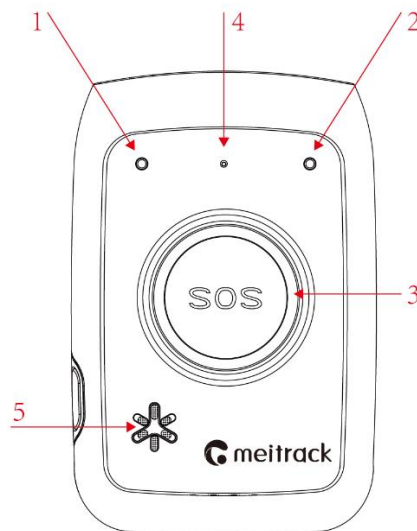



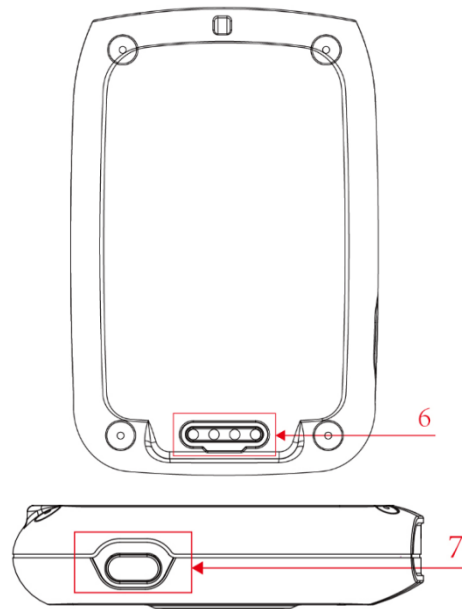

No.	Item	Description
1	GPS LED indicator (blue) Power LED indicator (red)	Indicates the GPS status. For details, see the section 2.6.2"LED Indicator."
2	WCDMA/GSM LED indicator (green)	Indicates the WCDMA/GSM status. For details, see the section 2.6.2"LED Indicator."
3	SOS button	<ol style="list-style-type: none"> <li>1. Press and hold down the button for three seconds in case of emergency. Then the device will beep for four times and vibrate to alert users. The device will also dial five authorized phone numbers in sequence. It will stop dialing when a phone number responds. Meanwhile, the device will send an SMS with positioning information to authorized phone numbers. If the GPRS/UMTS function is enabled, the device will send a GPRS/UMTS message to the server.</li> <li>2. In the sleep mode, short press the button to wake the device up.</li> <li>3. When a call is coming in, short press the button to answer the telephone.</li> <li>4. During the telephone conversation, short press the button to turn up or turn down the device.</li> </ol>

		When the device is at maximum or minimum volume, it will vibrate once.
4	Microphone	The microphone will operate automatically when the listen-in or calling function is used.
5	Speaker	The speaker will operate automatically when the calling or voice broadcasting function is used.
6	Magnetic charging port	The magnetic charging port is used to charge the device, configure device parameters, and upgrade software.
7	Auxiliary button	<ol style="list-style-type: none"> <li>1. When the device is turned off, press and hold down the button for three seconds to turn on the device.</li> <li>2. When the device is turned on, press and hold down the button for five seconds to turn off the device.</li> <li>3. When a call is coming in, short press the button to reject the phone call.</li> <li>4. During the telephone conversation, press the button to end the telephone conversation.</li> <li>5. In standby mode, short press the button to report the current power status. If the red LED indicator blinks once, it means that your device reaches 10% battery power left.</li> <li>6. In standby mode, press the button five consecutive times within five seconds. Then the device vibrates once. After the Bluetooth is enabled, the device enters pairing mode. If the Bluetooth fails to be paired within two minutes, it is disabled automatically.</li> <li>7. When the device is turned off, press the SOS button and auxiliary button to turn on the device. Then the device enters the upgrading mode.</li> </ol>

### 2.6.2 LED Indicator

To start the device, press and hold down the auxiliary button for 3–5 seconds. Then the blue and green LED indicators blink fast.

<b>GPS LED Indicator (Blue)</b>	
<b>Indicator Status</b>	<b>Description</b>
Blink fast (0.1 seconds on and 0.1 seconds off)	The GPS module is being initialized.
1 second on and 3 seconds off	No GPS signal is received.
Blink once every 3 seconds	A GPS signal is received.
Steady off	The device is turned off or enters sleep mode or power saving mode.
Blink fast (0.3 seconds on and 0.3 seconds off)	The battery power is low.
<b>GSM LED Indicator (Green)</b>	
<b>Indicator Status</b>	<b>Description</b>
Blink fast (blink once every 0.1 seconds)	The device is being initialized.
Blink once every 3 seconds	A GSM signal is received.
1 second on and 3 seconds off	No GSM signal is received.
Steady on	The subscriber you dialed is busy now.
Steady off	The device is turned off or enters sleep mode or power saving mode.
<b>Power LED Indicator (Red)</b>	
<b>Indicator Status</b>	<b>Description</b>
Steady on	The device is charging.
Steady off	The battery is full.
Blink fast (0.3 seconds on and 0.3 seconds off)	The battery is low.
Blink once	The battery percentage is 10%. Users can press the auxiliary button to query the battery power left.

### 3 First Use

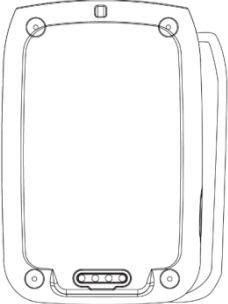
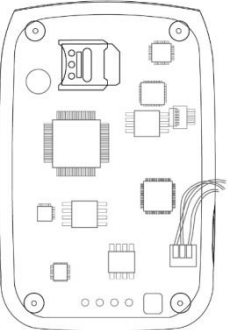
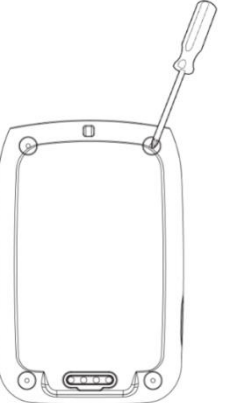
	<p>1. Remove the battery cover.</p> <p>With the back panel facing you, remove the battery cover.</p>
	<p>2. Insert a SIM card.</p> <p>Gently push the Nano SIM card (size: 12 mm x 9 mm) into the card slot with the gold-plated contacts facing down.</p> <p>Note: Ensure that the SIM PIN lock is closed properly, and the SIM card has enough balance and has subscribed the call ID service. Before using the calling or listen-in function, ensure that this function is supported by the embedded SIM card. If users want to use the calling function of the 4G P88L device, ensure that VoLTE is supported by the embedded SIM card.</p> <p>(Caution: Do not pick up the battery after removing the battery cover.)</p>
	<p>3. Install the battery cover.</p> <p>Put the battery cover back and fasten the four screws on the battery cover.</p>

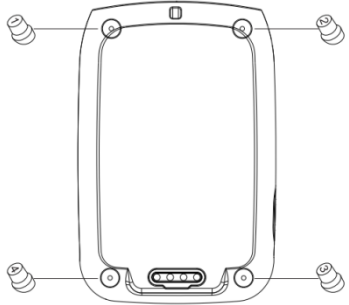
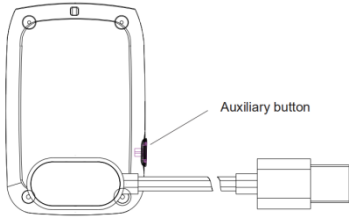
	<p>4. Install water resistant rubber stoppers.</p> <p>Take water resistant rubber stoppers out of the packing box, and install them properly.</p>
	<p>5. Charge the battery by magnetic USB cable.</p> <p>To charge the battery, connect the device to the wall charger or a computer through the magnetic USB cable. When you use the device for the first time, you are advised to turn off the device and then charge the battery for one hour.</p> <p>Note: Do not remove the battery unless necessary during charging. While charging, the device may heat up. This phenomenon is normal and does not affect the device's lifespan or performance. If the battery power is low, it may affect positioning and data transmission. So you need to charge the battery before using.</p>

After the Nano SIM card and battery are installed properly and the battery is charged, users can turn on the device and start to use it for the first time.

Please read the following instructions to know more about its functions.

## 4 Device Configuration

This chapter describes how to use Meitrack Manager to configure device parameters. For details about Meitrack Manager, see the *MEITRACK Manager User Guide*.

### 4.1 Configuring Device Parameters on Your PC

Before using Meitrack Manager, install the USB driver and Meitrack Manager. (If the operating system of the PC is Windows 10, maybe the USB driver already exists.)

Connect the device to the PC by using the USB cable.

Right-click **My Computer**, select **Manage**, and view **Device Manager**. If **SIMicroelectronics**

**Virtual COM Port (COM8)** is displayed as follows, the data communication is successful.



Run Meitrack Manager, then the software will automatically detect the device model, as shown in the following figures.

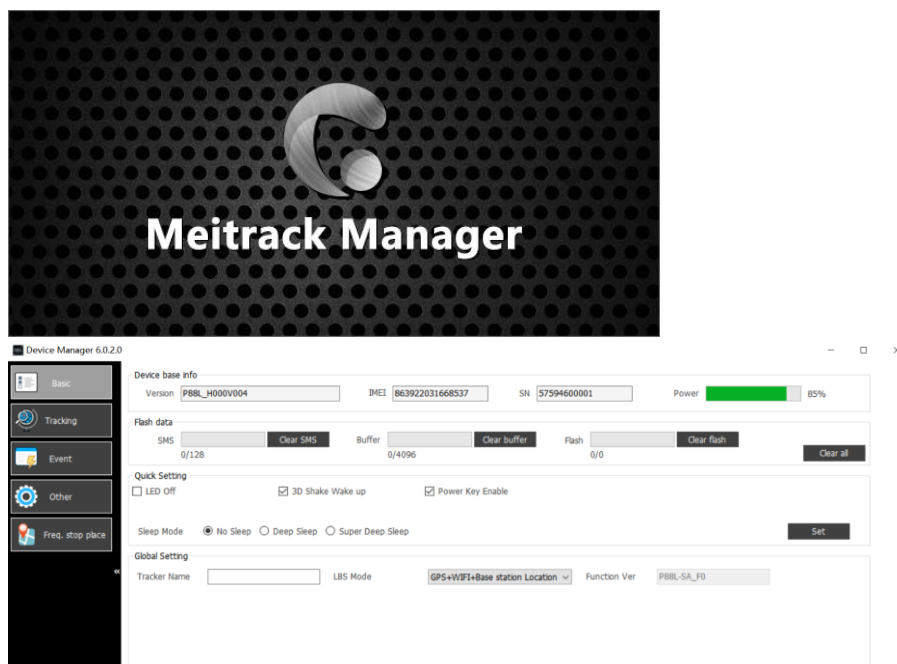

Note: The Meitrack Manager software is included in the CD delivered with the tracker. The software language will be automatically switched according to the language of the operating system. If you want to manually switch the language, click **Option** in the lower left corner of the interface.

## 4.2 Configuring Device Parameters on Your Phone

If there is no computer in hand, download the MP-Safe app on your phone, enable the Bluetooth, and configure device parameters on the phone by Bluetooth or GPRS.

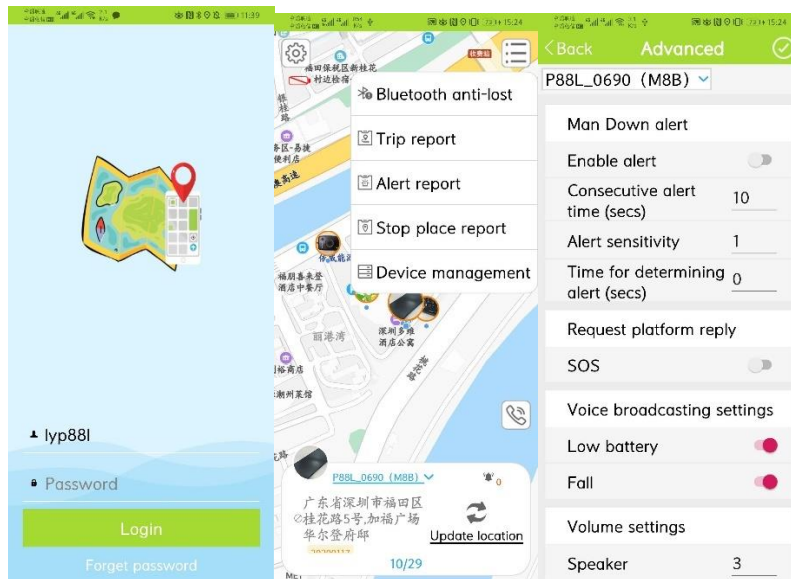

## 5 Logging In to MS03 Tracking System

Visit <http://ms03.trackingmate.com>, enter the user name and password, and log in to the MS03. (Please purchase a login account from your supplier.)

For more information about how to add a device, see the *MEITRACK MS03 GPS Tracking System User Guide* (chapter 4 "Getting Started").

**The MS03 platform supports the following functions:**

- Track by time interval or distance.
- Query historical trips.
- Set polygonal geo-fences.
- View different types of reports.
- Send commands in batches.
- Support OTA updates.

For details, see the *MEITRACK MS03 GPS Tracking System User Guide*.

## 6 Safety and Usage Instructions

**Only Meitrack-approved accessories can be used.**

Incompatible accessories may result in equipment damage or personal injury.

**Operate and handle the battery and charger carefully.**

- Only batteries and chargers specified by Meitrack can be used. Incompatible batteries and chargers may result in equipment damage or severe personal injury.
- Do NOT place batteries or trackers on fire or inside/on heating devices, such as microwave

ovens, ovens, or radiators. Batteries may explode when overheated.

## 7 Battery Disposal



The Waste Electrical and Electronic Equipment Directive (WEEE Directive) is applicable in European Union and other European countries that carry out the waste sorting and recycling system.

This symbol in the user manual means that the tracker and its accessories (such as chargers, batteries and USB cables) cannot be disposed of with other household waste when they reach the end of their life. If waste electrical and electronic equipment is not properly disposed of, they may cause harm to the environment or result in personal injury. To prevent the harm, please dispose of or recycle them separately from other waste so as to boost resource recycling and reuse.

**If you have any questions, do not hesitate to email us at [info@meitrack.com](mailto:info@meitrack.com).**