

KCV-S701EBC MANUAL

[7" Digital Color LCD Videophone]

COLOR HANDSFREE VIDEOPHONE



- 7 inch color digital LCD screen
- Call & Communication with a visitor
- Expandable up to 2 door cameras and 4 indoor units
: Monitor with sub-interphone (KIP-32GU)
- Video and Audio monitoring of the door cameras
- Operating condition display with icons (OSD)
- Door open

Thank you for purchasing our product.

Read safety instructions and manual carefully before using the product.

KOCOM CO.,LTD.

Cautions for safety







For safe use, please stick to the following cautions.

- Please, save this manual after reading these instructions carefully.
- This Cautions for Safety may include items that are not contained in specifications of the product that consumer purchases.
- If you need assistance with the set-up or operation, please contact with A/S center.
- Read and understand all instructions to set up rightly.

The important marks in the manual.

To help our customers to understand this manual, to prevent any personal injury or property damage, some marks are used in the manual. The marks and the drawing signs are below. Please, understand the marks before reading the manual.

The meaning of the drawing signs.

 Sign to show what not to do.	 Mishandling the device with ignoring this sign may result in serious injury or death.
 Mishandling the device with ignoring this sign may result physical injury or material damage.	
 Sign to tell you that you should follow the instructions.	 Sign to tell you that you need more attention including (high voltages, electric shock, danger, warning)
 Sign to tell you that you can't disassemble this unit.	 Sign to tell you that you must unplug the unit.

Caution

Cautions for set-up

- The law limits distributing the power lines to an authorized person from government. The work by unauthorized person may cause fire or electric shock.
- Place this unit securely on a stable surface. Serious damage and/or injury may result if the unit falls.
- Do not set up this unit near the leaking place because it may expose you to dangerous voltages or other risks.
- Even if your product is water proof, do not install it slanted place of water leakage, which can a short circuit.
- Fix the product on the wall safely according to the installation guideline to prevent any damage or injury.
- Don't put any stuff in 30cm around the monitor, not to block the air hole.
- The work of distributing wires needs skills and experiences. So please, for assistance, contact your dealer or call service center.
- The communication lines should be built in being distant from the power source.



- This may result in the risk of fire, electric shock and communication disruption.
- Setting the communication lines in a high humid place such as outside without any protection from rain causes the communication disruption.
- Keep the hook at the wall-mounted device safe. The hook may cause the physical injury.
- Think about the thickness and quality of wall material. The unqualified material may make the device fall.



- Set the device of the wall-mounted type not to fall. Falling from an earthquake causes personal injury.

Cautions for Repairs and Maintenance



- Keep the inside of the device clean. Having the dust inside without any cleaning for a long time causes the fire. If necessary, contact your dealer or service center to get cleaning service.



- Unplug this device when you want to check the inside. If there is no plug, please, turn off the circuit breaker.
- Unplug this device when you try to move it to another place.
- If the electric line is connected inside of the unit, please contact your dealer or service center.



- Do not use liquid or aerosol cleaners. Use a damp cloth for cleaning.

Warning

Warnings for Usage

- Do not install this unit near the water and dust, for example, in a bathroom or near the washing machine. It caused fire and electric shock.
- Do not install this unit near the fire, for example, near kitchen sink, heater or the like.
- Do not install near the noxious gas such as Hydrogen Sulfide, metal power and the like.
- Do not install near the water and chemicals.
- Do not give any damage, break and modify the plug. Overloading, heating, pulling causes the damage.
- Do not place the plug near the heater. The damaged cord causes fire and electric shock. Do not pull the power cord when unplugging.
- The damaged cord causes fire and electric shock. Must pull with plug. Do not touch with wet hands. It causes the electric shock.
- Do not use any other voltage, except the marked regular voltage.
- Do not use the power terminal at the units to other electric device except the designed device.
- Do not install the units at the leaking place if it doesn't have any waterproof mark. Do not install the unit when the power is on.
- Install the circuit breaker after checking the safety such as electric shock and leakage. Turn off the power before you install or A/S



- Check the suitability of the lines for installing when you use the exiting lines.
- Do the wiring work by using the designed material.
- Connect the electric wire with the designed ways and ground.
- Do not connect with any other devices except the designed devices to compose the system.



- Unplug electric wire and communication lines from the units before moving to another place.

▶ Cautions for Use

- This unit is not designed for security purpose.
- Do not place a pot with water or a small metal material on the Units.
- Do not cover the ventilating opening or put any metal material in the units.
- During thunderstorms, avoid using this unit. There may be a remote risk of an electric shock from lightning.
- Do not modify the unit.
- Do not handle the unit with the wet hands.
- Open the main gate after checking ID if the image and sound system do not work. Call A/S



▶ Cautions for Abnormality

- Change the damaged electric cord.
- Unplug this unit from plug socket and refer servicing to an authorized service center when the following conditions occur:
 - If liquid has been spilled into the unit.
 - If the unit does not work normally by following the operating instructions.
 - If the unit exhibits a distinct change in performance.
 - If the unit has been dropped or physically damaged.
- The mains plug, as a disconnection device, shall remain readily accessible by the user.



Caution

▶ Safety Instructions, Warnings and Cautions of Each System

- Do not disassemble this unit at will as this device is composed by precision parts.
- Do not touch or insert any foreign substances, for example, sticker, magnetic, opener and the like.
- Make U-type at the end of wires as the rain can effect on the system by following the wires during the rainy season.
- Install the unit by following the set-up instructions of Kocom.

▶ Videophone

- Separate the AC/DC lines with the hook of the wall-mounted type when installing.
- Do not distribute signal line with AC line.
- Do not clean the LCD with the damp cloth for cleaning. Use the only dry and soft cloth.
- Connect the lines after peeling the wires properly.
- Use the designed driver to connect the lines to terminal.
- Do not install the main gate monitor at the leaking place.

▶ Things You Need to Know

- This product is designed as a home videophone and cannot use continuously like monitor camera.
- If there is temperature difference between inner part of camera and surrounding, dew condensation occurs on camera lens and may disturb image.
- If dew condensation is removed from camera lens, image quality recovers.
- White LED light examination range is narrower than camera shot range at night, so there is less amount of light at night than day.
- So it is difficult to see the face in low illumination condition due to noise increase on screen, but it is not from defect.
- Monitor screen (liquid crystal panel) is not in defect when some pixels always light or black out.
- Please install monitor and camera over 5M away.
- Also, avoid installing at a place with too much noise, because too much noise around camera causes phone call inferiority.
- Do not place an object within 20cm in front of monitor. It causes phone call inferiority, especially because microphone is installed at the top of monitor.
- If strong light such as sunlight flows into camera module, screen saturation (or strange mark) and image shaking might occur.
- This is not a defect, so please do not install camera where a direct ray of light do not flow if possible.

▶ Cautions

- In some cases there is occurrence of product destruction, malfunction, noise mixing and picture quality deterioration due to mixing of other tools induced, voltage or thunder with communication wiring of monitor/camera, monitor/extended monitor.
- Do not wire with power line such as outdoor wiring or AC power, or phones and other tools.
- You cannot use it if you incorrectly wire the AC voltage between monitor/camera, monitor/extended monitor.
- Call the store or agency where you purchased this product and consult to solve the problem.
- Beware that unfixable damage might be caused due to authorizing AC voltage on communication wiring of monitor/camera, monitor/extended monitor.
- Do not ever disjoint this product. It may cause electrocution accident when touching high-voltage circuit inside this product.
- Outside power authorizing this product must be confirmed of product description and use rated voltage.
- Beware that if higher voltage is authorized, unfixable damage might be caused due to product destruction.
- Power must be connected to domestic voltage (product rated voltage) consent or interior wiring.
- If connected to other motive power or inverter-type power, product destruction, noise mixing, and picture distortion may occur.
- Do not drop this product. Glass is used for monitor and might break, or cause other circuit inferiority.
- In such case, immediately turn down the power switch, and call to consult agency or store in which this product was purchased.
- Keep away from any conditions where water splatters or falls. Do not place anything containing water like a vase on the product.
- If installed near transmission antenna such as broadcasting station, electric wave may mix and cause picture distortion or voice mixing.
- Avoid installing near tools with strong electromagnetic waves such as microwaves and cell phones, or it may cause picture distortion.
- Do not install monitor in following places.
 - ① Above or around water heater, rice-cooker, heater
 - ② Place exposed to direct rays of the sun
 - ③ Place with temperature below 0°C such as cold store
 - ④ Place with high humidity such as bathroom, washroom, heated room
 - ⑤ Place with a lot of gas, dust, smoke
 - ⑥ Dangerous place with sprays of water or chemicals
- Do not wipe with insecticide, drugs or chemicals such as thinner and alcohol, or it may damage the surface of this product.
- Beware of occurrence of image quality deterioration or malfunction from cause of humidity due to penetration of chemicals or water into camera's urea resins.
- As in the picture, it prevents temperature difference of camera (outside) and monitor (inside), and removes dew condensation caused by humidity of camera window.
- Camera must be installed when wall cement is completely dry.
- When product is installed in winter below -5°C, wait for approximately 2 hours to connect. Dew formation in monitor and camera due to temperature difference inside and outside may cause product defect.
- Avoid installing monitor and camera in place directly exposed to heat or where gas noxiousness is highly occurring.

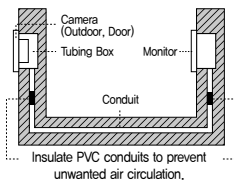

Installation location

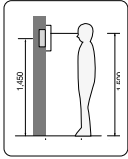

■ Monitor installation location

- Standard monitor installation height is about 1,500mm where screen center is at eye level.
- In this case, wall-hanging metal center (center of piping) is 1,450mm above ground level.
- Standard installation height

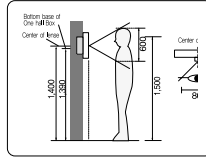

■ Camera installation location

- Camera installation in height Standard camera installation height is when lens is about 1,400mm above the floor.
- In this case, camera stack center (piping box) is above 1,390mm above ground level.
- Standard installation in height

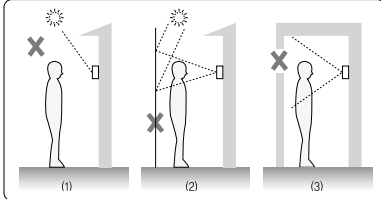

■ Caution of camera installation

- Avoid installing camera exposed to direct ray of light (and sun).
- Beware backlight and darkness of visitor's face, which makes identification difficult.
- Avoid installing camera in places such as the following picture.
 - Place illuminating sky as background
 - Place with white wall reflecting direct ray of light
 - Enclosed place without light source

■ Monitor installation

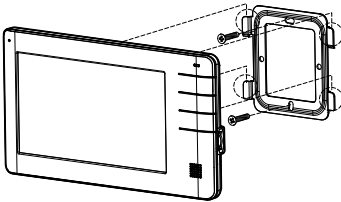

■ Directly connecting cut-off power cord with power wire

- Do not do such electric work on your own. Installing product in this way requires reliance on electric installation man with electric work license.
- Insulate with insulating tape while cutting off power cord and connecting with power wire so electric wire metal does not expose. Contact between exposed electric wires cause fire or electric shock accident.
- Such electric work requires connection after interception of supplied power.

- Remove wall hanger frame metal behind monitor.
- Install wall hanger frame metal on 1 type box or wall with attached Vis.
- Connect wiring to monitor back terminal referring to product connection diagram.
- Hang monitor on metal wall hanger frame and fix monitor on metal wall hanger frame

■ Door camera installation

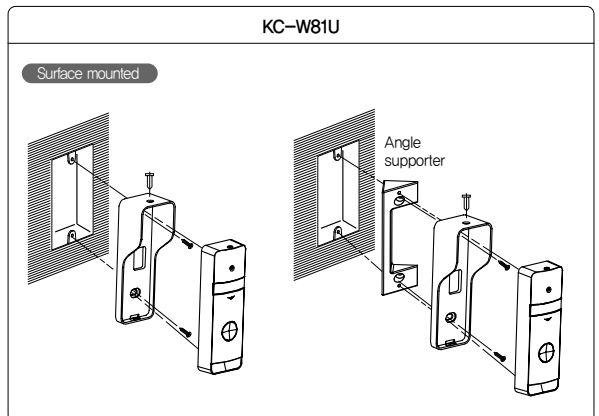
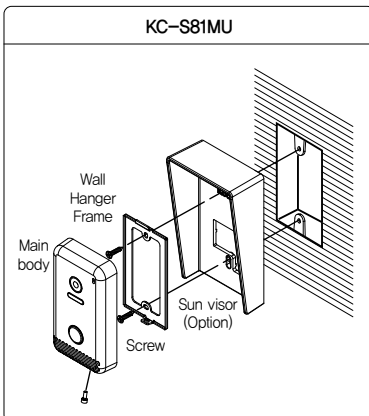

Components of product

■ Monitor

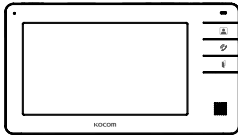

■ Wall hanger frame

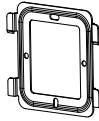

■ Screws



4X25mm 4ea

■ Wire



4Pin cable for camera x 2ea
4Pin cable for Intercom x 1ea
4Pin cable for EX-monitor x 2ea
4Pin cable for EX-intercom x 1ea
4Pin cable for Audio Phone x 1ea



2Pin cable for DC (Out) x 1ea

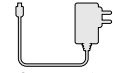

DC adapter x 1ea

(Only included for DC type)



3Pin cable for door opener x 1ea

■ Door camera

■ KC-S81MU

■ Wall hanger frame

■ Sun visor (Option)

■ KC-W81U

■ Hood Cover

■ Angle supporter

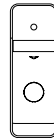
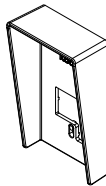
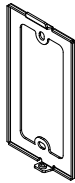
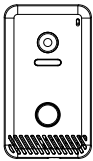

■ Screws



M3X8mm 1EA Screws for fixing main body on the wall



"L" Wrench 2.5M/M 1EA



4X50mm 2ea

Screws for fixing hanger frame body on the wall

■ Wire



4Pin cable for camera x 1ea



3Pin cable for door opener x 1ea

■ Screws

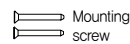

Mounting screw

KA M4X35mm 2EA



Fixing hood cover

PM M3X6mm 1EA

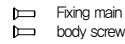

Fixing main body screw

KM M4X10mm 2EA



H2 "L" Wrench 1EA



Plastic expansion pipe

M4X35mm 2EA



Rubber stopper of regulating hole

Specifications

	Model No.	KCV-S701EBC(DC)	KCV-S701EBC(AC)
	Monitor	Power Source	DC 15V 1.5A
Power Consumption		1W(±20%)(On Stand by), 7.5W(±20%)(In load)	
Operating Temperature		0°C ~ +40°C	
LCD		7 Inch color LCD	
Communication System		Handsfree type	
Wiring		Door camera : Polarized 4 wire Ex_Monitor : Polarized 4 wire Door opener : Polarized 3 wire Interphone : 4 Wires direct to each monitor and additional 4 Wires between monitors Lobby phone : Polarized 6 wire	
Door Camera	Mount Type	Surface mount	
	Dimension	220(W) x 123(H) x 19(D) mm	220(W) x 123(H) x 22(D) mm
	Model No.	KC-S81MU	KC-W81U
	Power Source	DC 10V ~ 15V (Power from monitor)	DC 10V ~ 15V (Power from monitor)
	Power Consumption	Max. 2.8W	Max. 2.8W
	Operating Temperature	-10°C ~ +50°C	
Dimension	70(W) x 125(H) x 21(D) mm	40(W) x 122(H) x 21(D) mm	
Angle of Lens	Diagonal 120 °	Diagonal 50 °	

Name and functions of each part

■ Monitor

· Front

· Side

· Back

< KCV-S701EBC(DC) >

< KCV-S701EBC(AC) >

<ul style="list-style-type: none"> ① MIC ② Power LED ③ Monitoring button ④ 1 – Call button : Connect talk with the door camera <li style="padding-left: 20px;">2 – Extension call <li style="padding-left: 20px;">3 – Guard call : When in standby can press call guard ⑤ Open door button : Open the door 	<ul style="list-style-type: none"> ⑥ LCD Monitor ⑦ Speaker ⑧ Jog switch ⑨ Terminal
---	--

■ Door camera

KC-S81MU

· Front

· Back

· Door camera+Sun visor(Optional)

<ul style="list-style-type: none"> ① MIC ② CAMERA LENS ③ LED ④ CALL BUTTON ⑤ SPEAKER 	<p>A. Connection for monitor ①VCC ②GND ③AUDIO ④VIDEO</p> <p>B. Connection for door opener ①COM ②NO ③NC</p>
---	--

KC-W81U

· Front

· Back

<ul style="list-style-type: none"> ① CAMERA LENS ② IR LED ③ MIC ④ CALL BUTTON ⑤ SPEAKER 	<ul style="list-style-type: none"> ⑥ MIC volume adjust ⑦ Speaker volume adjust ⑧ Wires for monitor ⑨ Wires for door opener
--	--

Product connection diagram

■ System configurations_Push button lobby phone

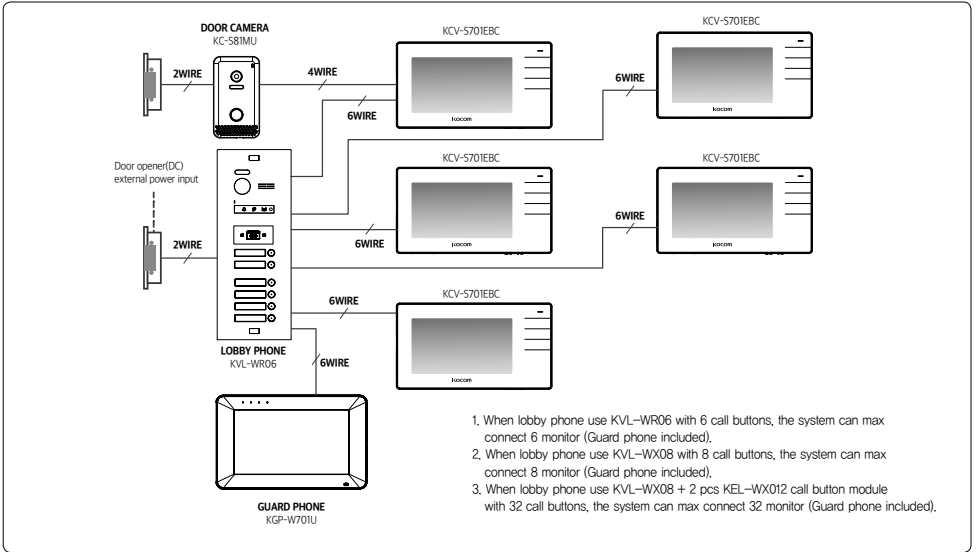

■ System configurations_Keypad lobby phone

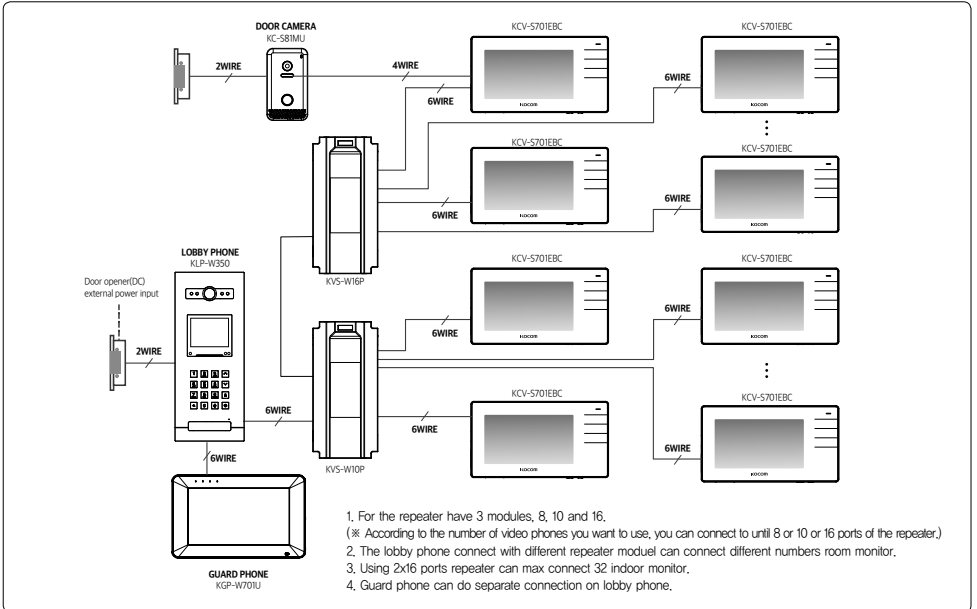

⚠ Caution

- ※ The system wiring order is supposed to be like this : 485-, 485+ connects to Blue/White + Blue twisted wire / GND, Audio connects to Brown/White + Brown twisted wire / Power, Video connects to Green/White + Green twisted wire / And the rest Orange/White + Orange twisted wire will be connected to GND wire.

Product connection diagram

Terminal

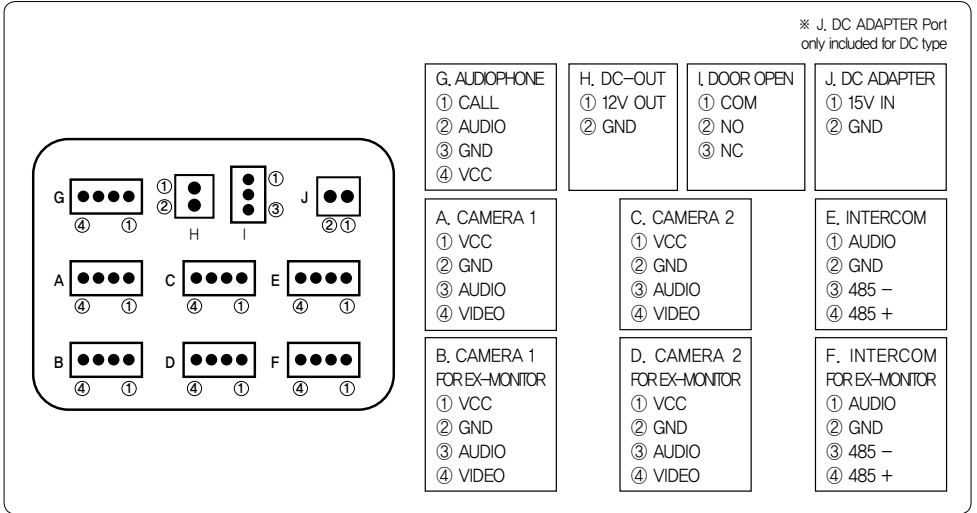

Cable requirement – Based on distance from lobby phone to monitor

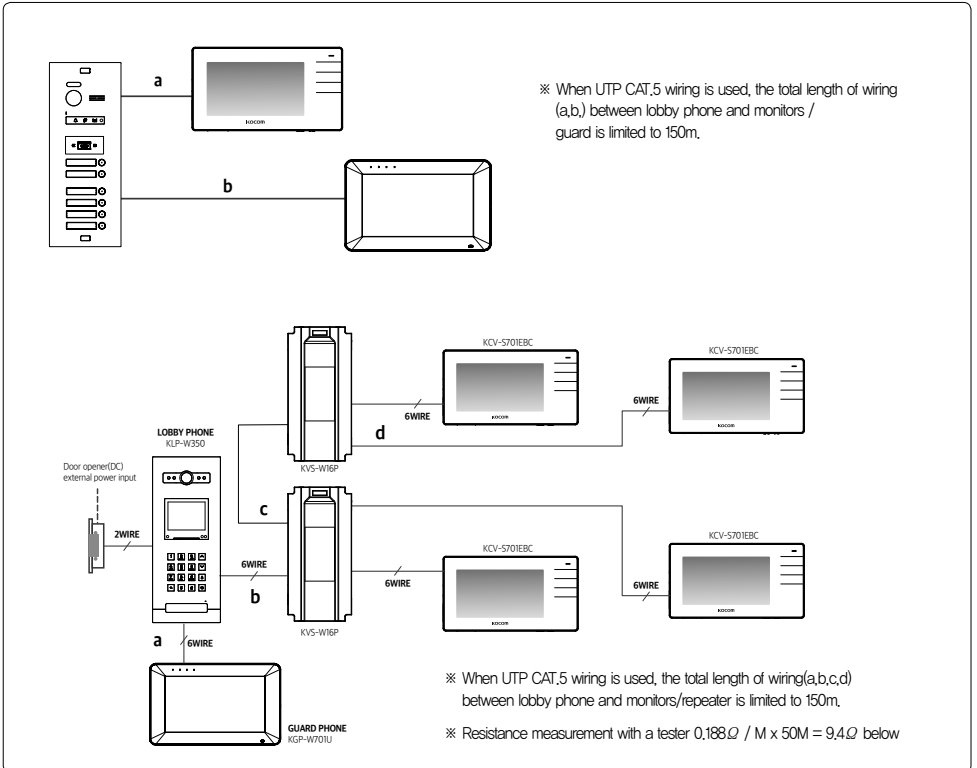

Instructions for operation

■ Communication from door camera & Door open

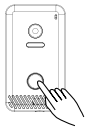

Press the call button to make a call



Identify the visitor from monitor.
(Standby time : 30sec)



Push the [Talk] button and communicate with the door camera.
(Communication time : 3 minutes)

Push the [Talk] button again and stop the communication,

When talk is in progress, adjust the volume by controlling the jog switch up and down.
(Variable range : 1~4)



While [Talk] on. Push [Door Open] and the door will be opened.
Door open time can be set from 1sec~10sec.

■ Camera monitoring



Press the monitoring button once to monitor door camera 1.

When monitoring is in progress, adjust the screen (brightness/color/contrast) by controlling the jog switch up and down.
(Variable range : 1~10)



Press the monitoring button one more time to monitor door camera 2.



Press the monitoring button one more time to end monitoring.

Instructions for operation

■ Extension calling & Receiving function

※ In case of extended monitors or interphones, you can perform extension calling.
To perform extension calling, you must set each device's numbering.

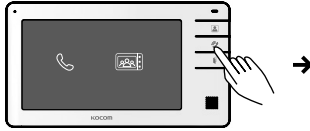

Press the '📞' button once to internal call.

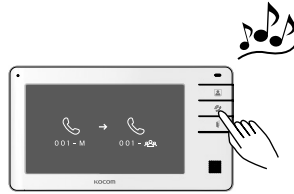

When pressing a '📞' button, that slave monitor or interphone calling will be in operation.
(Communication time : 3 minutes)

■ Call to the other guard phone

Master-0 device only

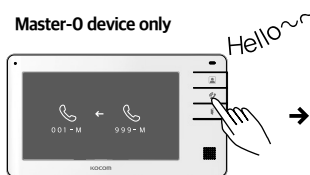

Press the '📞' button then calling gets connected.



Press the '📞' button to end internal call.

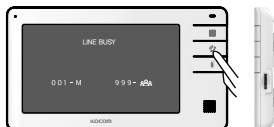

When the indoor monitor or guard phone is monitoring the lobby phone or talking with the lobby phone, the guard phone/indoor monitor do intercom call will display line busy.

Menu setup

■ Adjusting talking sound from door camera and lobby phone

When talk is in progress, adjust the volume by controlling the jog switch up and down. (Variable range : 1~4)

■ Adjusting brightness

When monitoring is in progress, adjust the screen 'Brightness / Color / Contrast' by controlling the jog switch up and down. (Variable range : 1~10)

■ Setting menu

- Press the jog switch on idle screen to enter in setup menu.
- Control the position of cursor by controlling the jog switch up and down.
- Menu is selected by pressing the jog switch
- After making a selection, change the setting value of selected menu by controlling jog switch up and down.
- Press jog switch to exit from selected menu.
- Setting value is saved when exit menu is selected.

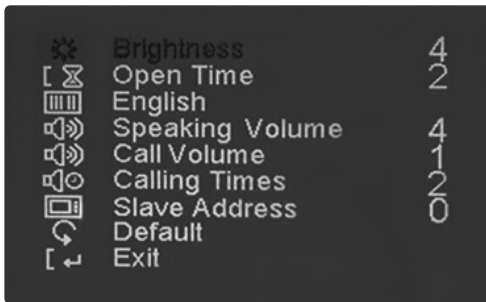

- Brightness : Adjust brightness (Variable range : 1~10)
- Open time : Adjust door open time (Time : 1~10 seconds)
- Language : Select language (English)
- Speaking Volume : Adjust talking sound from door camera (Variable range : 1~4)
- Call Volume : Adjust calling sound (Variable range : 0~4, 0 : mute)
- Calling times : Change number of calling sound (2 beats or 4 beats)
- Slave Address : System specifications = Set monitor address (0~Master, 1~3~Slave)
General specifications = Set monitor address (1~Master and Slave)
- Default : Set value to default
- Exit : Exit from set-up menu

■ Setting monitor address on system

- Press the open door button 5 times right after monitor power restart to access the monitor address setting page.
- When enter the monitor address setting page, press the side jog switch once to choose corresponding digits, then you can set the Monitor address from 001~998 by sliding jog switch up and down.
- After finishing address setting, press the side jog switch again, then press call button and monitoring button by order to save the address setting.

※ Address 999 is the guard phone address, the Indoor monitor can not use the 999 for monitor address.

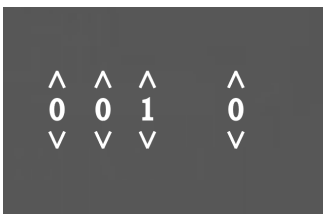

Warranty

▶ To receive after service, have the following ready before you contact our branches.

1. Name of the product.
2. Model number of the product.
3. The area of problem.
4. Phone number and address at which you can be contacted.

Warranty Card

PRODUCT	
MODEL	KCV-S701EBC(DC) / KCV-S701EBC(AC)
DATE PURCHASED	
WARRANTY PERIOD	
AGENCY ADDRESS	

▶ KOCOM Warranties the original purchaser of this product as follows.

- 1) This product is produced under strict quality control and inspection procedures.
- 2) If this product breaks down during proper use as a result of product defect, KOCOM will repair it within one year from date of purchase free of charge.
- 3) The following cases will be subject to charge, even during warranty period:
 - a. Breakdown during transport, or through careless treatment, by consumer.
 - b. Breakdown cause by unauthorized repair, or system modification.
 - c. Breakdown caused by natural disaster or power disruption.