

Twist-Lock® Devices
 30A, 3 Phase Y 120/208V AC; 4 Pole, 5 Wire
 Grounding
 Insulgrip® Connector

HUBBELL

Features

- Ribbed nylon housing provides a secure grip and impact and chemical resistance.
- Superior cord grip design protects terminations from excess strain.
- Clear, funnel shaped wire entry for ease of termination.
- Integral dust shield protects wiring chamber from dust or contaminants.

Ordering Information

Description	Cord Diameter	UPC	Catalog Number
Black and white nylon.	.35"-1.15" (9-29)	78358503965	HBL2813

Listings

Listed to UL 498
 Fed.Spec. W-C-596
 Certified to CSA C22.2 No.42

Specifications

Housing / Cord Clamp	Nylon
Terminal Retainer	Clear polycarbonate
Contacts	Brass
Terminal Screws	#10-32 Brass (Phillips / Slotted / Robertson)
Terminal Clamp	Cold rolled steel – nickel plated
Assembly Screws	Steel - nickel plated

Performance

Electrical	
Current Interrupting	Certified for current interrupting at full rated current
Dielectric Voltage	Withstands 2,000V minimum
Mechanical	
Terminal Accommodation	#16 AWG - #8 AWG stranded copper wire only.
Terminal Identification	Terminals identified in accordance with UL 498
Environmental	
Flammability	HB or better per UL94 or CSA 22.2 No. 0.6
Operating Temperatures	Maximum Continuous 75°C Minimum -40°C (w/o impact)



30A 3ØV
 120/208V AC
 NEMA L21-30R
 UL/CSA
 3 HP

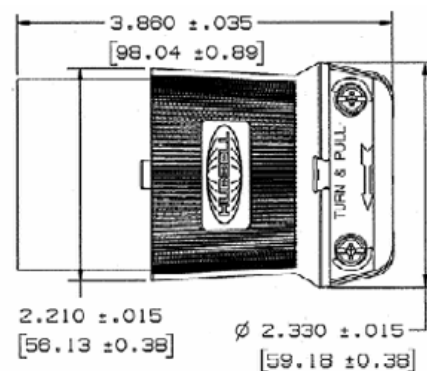

Accessories

Plug	HBL2811
Weatherproof Boot	HBL6036
Flanged Inlet	HBL2815
Weatherproof Boot	HBL6035

Resources

Customer Use Drawing
 eCatalog

Dimensions in Inches (mm)

Hubbell Wiring Device-Kellems • Hubbell Incorporated (Delaware) • 40 Waterview Drive • Shelton, CT 06484

Phone (800) 288-6000 • Fax (800) 255-1031 • Specifications subject to change without notice.

