

SAFETY MANUAL

XNX™

Universal Transmitter

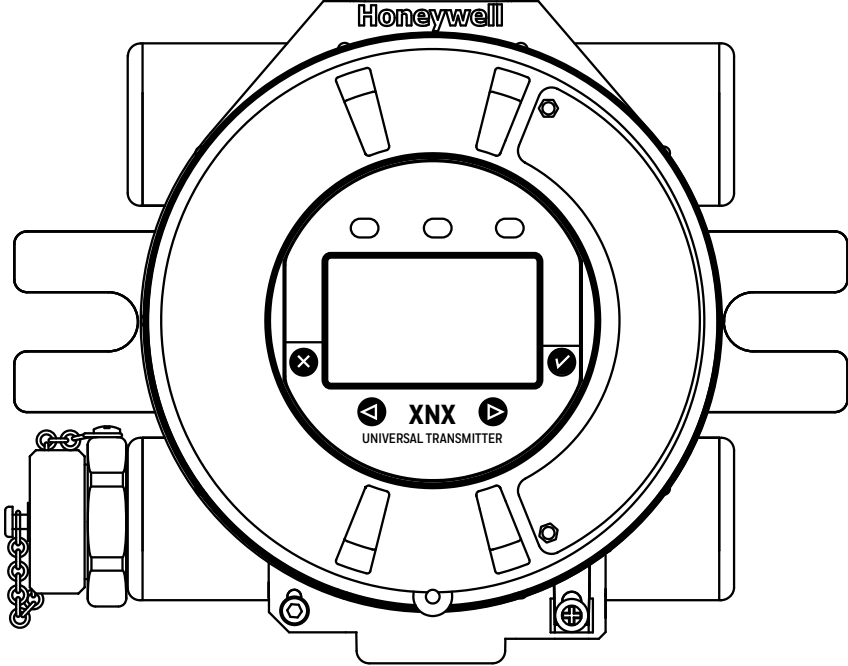

This page is intentionally left blank

Table of Contents

1	SIL 2 Certificate	3
1.1	XNX Gas Detector Transmitter.....	3
2	Overview	4
3	Safety Parameters.....	5
3.1	Interval of Proof Testing	6
4	Fault Diagnostic Time Interval	6
5	Proof Test.....	7
5.1	Purpose of Proof Testing.....	7
5.2	Expected Outcome of Proof Testing	7
5.3	Tolerance of Output Current Levels.....	7
6	Proof Testing Procedure	7
6.1	Checking	7
6.1.1	Force mA Output	7
6.1.2	Zero Gas mA Output.....	8
6.1.3	Calibration Gas mA Output	8
6.2	Adjusting	8
6.2.1	Calibrate 4.0 mA and 20.0 mA	8
6.2.2	Zero Gas Calibration and Span Calibration.....	8
6.2.2.1	Zero Gas Calibration.....	9
6.2.2.2	Span Calibration	9
6.3	Verifying mA Settings	10
6.4	Testing.....	11
6.4.1	Fault and Alarm State.....	11
6.4.2	Gas Verification.....	12



1 SIL 2 Certificate

1.1 XNX Gas Detector Transmitter

1.2 XNX ECC Sensor (Toxic gases)

* ECC sensor is SIL approved only if used with XNX transmitter

Certificate

Product Safety
Functional Safety
www.tuv.com
ID: 9630000090

No.: 968/EZ 319.07/20

Product tested	Gas Detector Transmitter XNX	Certificate holder	Honeywell Analytics Inc. 405 Barclay Boulevard Lincolnshire, IL 60069 USA
Type designation	XNX-ABCD-EFGGG A=Approval (A, U) B=Entry Type (M, T) C=Material (A, S) D=Personality (E, L, V) E=Option (N, R, M, F) F=Local HART (M, H) GGG=Sensor Range (NNN, CB1, IF1, IV1, IC1)		
Codes and standards	IEC 61508 Paris 1-7:2010		
Intended application	The XNX Gas Detector transmitter is suitable for safety related applications up to SIL 2 (IEC 61508).		
Specific requirements	For the use of the Gas Detector transmitter devices the installation instruction (released by Honeywell Analytics Inc), including recommendations for risk assessment and requirements for maintenance, the Technical Manual and the Safety Manual shall be considered.		
Valid until	2025-07-03		

The issue of this certificate is based upon an examination, whose results are documented in Report No. 968/EZ 319.07/20 dated 2020-02-03.
This certificate is valid only for products which are identical with the product tested.

TÜV Rheinland Industrie Service GmbH
Bereich Automation
Funktionale Sicherheit

Köln, 2020-07-03

Certification Body Safety & Security for Automation & Grid

Dipl.-Ing. (FH) Wolf Rückwart

TÜV Rheinland Industrie Service GmbH, Am Grauen Stein, 51105 Köln / Germany
Tel.: +49 221 805-1700, Fax: +49 221 805-1530, E-Mail: info@tuev.com

Certificate



No.: 968/EZ 493.02/19

Product tested	ECC Sensors for oxygen and toxic gases	Certificate holder	Honeywell Analytics Inc. 405 Barclay Boulevard Lincolnshire, IL 60069 USA
Type designation	XNXSH1SS, XNXSH1FM, XNXSH2SS, XNXSH3SS, XNXSF1SS, XNXSM1SS, XNXSS1SS, XNXSS2SS, XNXSJ1SS, XNXSO1SS, XNXSO1FM, XNXSA1SS, XNXSA2SS, XNXSL1SS, XNXSL2SS, XNXSX1SS, XNXSM1SS, XNXSE1SS, XNXSC1FM, XNXSC1FM, XNXSC3SS, XNXSG1SS, XNXSG2SS, XNXSR1SS, XNXSY1SS, XNXSZ1SS, XNXSP1SS		
Codes and standards	EN 50402:2017	IEC 61508 Paris 1-7:2010	
Intended application	The devices comply with the requirements of the relevant standards (SIL 2 acc. to EN 50402/IEC 61508) and can be used in applications up to SIL 2 acc. to EN 50402/IEC 61508.		
Specific requirements	The ECC sensor shall be used in combination with the XNX universal transmitter. The instructions of the Technical and the Safety Manual shall be considered. The safe state is the de-energized state.		
Valid until	2024-07-23		

The issue of this certificate is based upon an examination, whose results are documented in Report No. 968/EZ 493.02/19 dated 2019-07-23.
This certificate is valid only for products which are identical with the product tested.

TÜV Rheinland Industrie Service GmbH
Bereich Automation
Funktionale Sicherheit
Am Grauen Stein, 51105 Köln

Köln, 2019-07-23

Certification Body Safety & Security for Automation & Grid

Dipl.-Ing. Thomas Stoffens

TÜV Rheinland Industrie Service GmbH, Am Grauen Stein, 51105 Köln / Germany
Tel.: +49 221 805-1700, Fax: +49 221 805-1530, E-Mail: info@tuev.com

www.fs-products.com
www.tuv.com

TÜVRheinland®
Precisely Right.

www.fs-products.com
www.tuv.com

TÜVRheinland®
Precisely Right.

2 Overview

IEC 61508 is a generic functional safety standard. Functional safety is defined in this standard as “part of the overall safety relating to the Equipment Under Control (EUC) and the EUC control system which depends on the correct functioning of the E/E/PES’ safety related systems, other technology safety-related systems, and external risk reduction facilities.”

A system is considered to be functionally safe if the random and systematic faults do not kill or injure humans, pollute the environment, and do not result in the loss of equipment or production.

A systematic fault is defined as a failure with a definite cause. A random fault can happen at any time and the cause is unclear. The terms fault and failure can be used interchangeably.

A Safety Integrity Level-certified system can detect the majority of safe and unsafe failures. XNX is SIL 2 capable per IEC 61508. XNX is SIL 3 capable in a redundant system per IEC 61508. [Table 1](#) and [Table 2](#) below outline a system’s safety integrity level in relation to its average probability of failure to perform its design function on demand and probability of dangerous failure per hour.

Table 1. Average Probability of Failure to Perform Its Design Function on Demand (Low Demand System)

Safety Integrity Level	Low demand mode of operation (Average probability of failure to perform its design function on demand (PFD))
4	$\geq 10^{-5}$ to $< 10^{-4}$
3	$\geq 10^{-4}$ to $< 10^{-3}$
2	$\geq 10^{-3}$ to $< 10^{-2}$
1	$\geq 10^{-2}$ to $< 10^{-1}$

Table 2. Probability of a Dangerous Failure Per Hour (High Demand System)

Safety Integrity Level	High demand or continuous mode of operation (Probability of a dangerous failure per hour (PFH))
4	$\geq 10^{-9}$ to $< 10^{-8}$
3	$\geq 10^{-8}$ to $< 10^{-7}$
2	$\geq 10^{-7}$ to $< 10^{-6}$
1	$\geq 10^{-6}$ to $< 10^{-5}$

NOTE:

The XNX system is Type B. A Type B system uses controllers or programmable logic per IEC 61508.

The XNX product consists of a main board, a personality board, and a sensor.

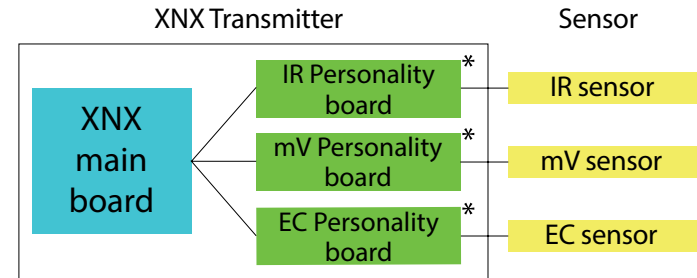

* Note: Only one personality board per XNX main board

This manual outlines the proof test procedure, a required operation to maintain the XNX’s functional safety under low demand applications.

In XNX output signals, only 4-20 mA is considered a safety function. Other output signals are optional signals and are not part of the SIL2 compliance.

3 Safety Parameters

The safety parameters listed below are a combination of the main board, personality board, and sensor. These numbers were provided by TUV in report 968/EZ 319.07/20. For safety parameters of the individual sensors, refer to the *XNX Safety Parameters For Sensors* white paper.

Component	SIL Level*	Safety Architecture	PFDavg**	SFF %	DC %		Test Report
XNX Universal Transmitter with Combustible Sensor (IR board)	SIL2	1oo1	2.06E-03	>90%	>90%		TUV 968/EZ 319.07/20
	λ (fit)	λ_{Du} (fit)	λ_{Dd} (fit)	λ_D (fit)	SC	PTC %	
	14768.96	447.14	6956.00	7433.14	2	100	

Component	SIL Level*	Safety Architecture	PFDavg**	SFF %	DC %		Test Report
XNX Universal Transmitter with Combustible Sensor (mv Catalytic bead) Sensepoint and Sensepoint HT detector	SIL2	1oo1	2.13E-03	>90%	>90%		TUV 968/EZ 319.07/20
	λ (fit)	λ_{Du} (fit)	λ_{Dd} (fit)	λ_D (fit)	SC	PTC %	
	18033.53	493.46	8571.96	9064.43	2	100	

Component	SIL Level*	Safety Architecture	PFDavg**	SFF %	DC %		Test Report
XNX Universal Transmitter with Toxic Sensor	SIL2	1oo1	2.42E-03	>90%	>90%		TUV 968/EZ 319.07/20 TUV 968/EZ 493.02/19
	λ (fit)	λ_{Du} (fit)	λ_{Dd} (fit)	λ_D (fit)	SC	PTC %	
	19119.01	559.55	9099.54	9659.09	2	100	

Component	SIL Level*	Safety Architecture	PFDavg**	SFF %	DC %		Test Report
XNX Universal Transmitter with Oxygen Sensor	SIL2	1oo1	2.42E-03	>90%	>90%		TUV 968/EZ 319.07/20 TUV 968/EZ 493.02/19
	λ (fit)	λ_{Du} (fit)	λ_{Dd} (fit)	λ_D (fit)	SC	PTC %	
	19119.01	559.55	9099.54	9659.09	2	100	

continued...

Component	SIL Level*	Safety Architecture	PFDavg**	SFF %	DC %		Test Report
XNX Universal Transmitter Standalone XNX Transmitter (main board)	SIL2	1001	1.71E-03	95.54	>90%		TUV 968/EZ 319.07/20
	λ (fit)	λ_{Du} (fit)	λ_{Dd} (fit)	λ_D (fit)	SC	PTC %	
	9283.11	395.99	4294.22	4690.21	2	100	

*This rating is highest achievable SIL level the XNX, Searchpoint Optima Plus gas detection system can achieve as standalone safety devices. In more complex safety system the above values are the safety parameters of XNX and Optima gas detection system required to determine the acceptance of the complete safety function (i.e., all safety parameters, safety architecture, etc.) as required by IEC 61508 and IEC 61511.

**Denotes a proof test interval of one year.

3.1 Interval of Proof Testing

1-year interval proof test is required for XNX SIL compliance. Perform the proof test once a year to comply with IEC 61508.

Section 6 Proof Testing Procedure outlines the actions that must be completed for a proof test.

4 Fault Diagnostic Time Interval

XNX conducts approximately 30 diagnostics total on the main board and personality board. These diagnostics occur at different time intervals, with the longest interval at 24 hours. But when a fault is detected, it is reported within 3 seconds. Refer to the XNX Technical Manual for more information on diagnostics.

5 Proof Test

5.1 Purpose of Proof Testing

A proof test is a periodic test to detect failures in the system so that, if necessary, the system can be restored to an “as new” condition or as close as practical to this condition.

5.2 Expected Outcome of Proof Testing

The following features are checked and adjusted if required

- current output at different levels (4.0 mA and 20.0 mA)
- verifying zero gas and span gas calibration current output
- verifying current output of warnings and faults
- simulating warnings and faults
- validation of the current output of zero gas and/or span gas calibration (required if the current output of zero gas and/or span gas calibration had to be changed)

5.3 Tolerance of Output Current Levels

The tolerance for the output current levels is ± 0.1 mA.

Example: If the procedure requires the current output to be 4.0 mA, the actual current reading at the controller end can range from 3.9 mA to 4.1 mA.

6 Proof Testing Procedure

6.1 Checking

The purpose of checking is to ensure the mA output meets the expected levels. If the current does not meet the expected levels, it will have to be adjusted. If, after completing [6.1.1](#), [6.1.2](#), and [6.1.3](#), the mA output does meet the expected levels, proceed to [6.3](#).

6.1.1 Force mA Output

1. Ensure the current can be measured at the controller end. The current will be measured using the procedures outlined in [6.1.1](#) to [6.1.3](#).
2. From the Main Menu, select the Test Menu (ⓘ).



CAUTION

The mA output set in this menu will revert to the normal operating values when exiting the Test Menu. For more information on setting the mA output levels for normal operation, see mA Levels in the XNX Technical Manual.

3. From the Test Menu, select Force mA Output (ⓘ).

The New mA Output screen shows the existing mA output in the left column. The user can adjust the output by changing the value in the column on the right.

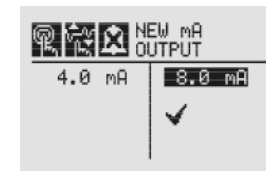

Figure 1. New mA Output Screen

4. Ensure the current at the controller end is 4.0 mA. If the current is not 4.0 mA, refer to [6.2.1](#) to adjust the output.
5. Repeat steps #2-4 to check the output of 20.0 mA.

6.1.2 Zero Gas mA Output

The procedure for zero gas is not applicable to the ECC O₂ sensor.

1. Apply zero gas to the sensor.
2. The current at the controller end should be 4.0 mA.

If the mA output is not at the expected level when applying zero gas, perform a Zero Gas Calibration. Refer to [6.2.2](#) and complete the procedure for a Zero Gas Calibration.

6.1.3 Calibration Gas mA Output

1. Apply calibration gas to the sensor.
2. The current measured at the controller end is related to the percentage of gas applied.

Example: 100% of full gas concentration is equivalent to 20.0 mA. If 75% of the full scale gas concentration is applied, the mA output should be 16.0 mA.

If the mA output is not at the expected level when applying calibration gas, refer to [6.2.2](#) and perform a Zero Gas Calibration and a Span Gas Calibration.

6.2 Adjusting

Perform the following procedures if 4.0 mA and 20.0 mA were not measured at the controller end. If the correct currents were measured, proceed to [6.3](#).

The current must be measured at the controller end in [6.2.1](#) and [6.2.2](#).

6.2.1 Calibrate 4.0 mA and 20.0 mA

1. From the Main Menu, select the Test Menu (🔧).
2. Then select Force mA output (🔧).
3. Adjust the current output in the column on the right until the current at the controller end is 4.0 mA.

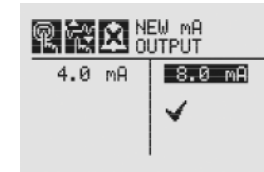

Figure 2. Adjusting Current

4. Once the new value is entered, use the ◀ ▶ switches to move to the '✓' and select ⏹ to set the mA output.

If the 20.0 mA output was not equal to 20.0 mA, complete steps #3-4.

6.2.2 Zero Gas Calibration and Span Calibration

The following section outlines the steps for calibrating the attached XNX sensors. For calibration information for specific sensors, refer to the XNX Technical Manual.

1. If using a compressed gas cylinder, push the calibration gas flow housing onto the bottom of the sensor and apply the gas.
2. Access the Calibration Menu.



Figure 3. Gas Calibration Menu

NOTE:

The Gas Calibration Menu is for both Zero Gas and Span Gas Calibration.

6.2.2.1 Zero Gas Calibration



Figure 4. Zero Gas Calibration Screen

As the sensor detects the zero gas and the concentration increases, the values displayed will reflect the changing concentration. When the concentration values are stable select to allow the XNX to calculate the zero adjustment. Selecting will return to the Gas Calibration Menu.



Figure 5. Zero Gas Calibration in Progress

3. If the Zero Gas Calibration is successful, the Zero Passed screen displays.

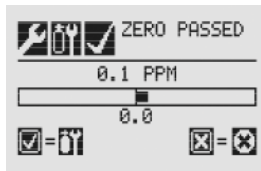

Figure 6. Zero Gas Calibration Passed

6.2.2.2 Span Calibration

NOTE:

If a Span Calibration is not required, select to skip the Span Calibration and return to the Calibration Menu.

1. When the Zero Gas Calibration is complete, the Span Concentration screen appears. The gas concentration for the Span Gas Calibration can be changed.

If the Span Calibration is skipped, the Gas Calibration screen displays.

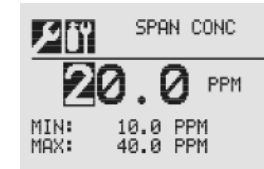

Figure 7. Span Gas Concentration Screen

2. Enter the concentration of the span gas by selecting to choose the first digit and use the switches to increment or decrement the values. Use to accept the new value and move to the next digit. Continue until all digits have been selected.

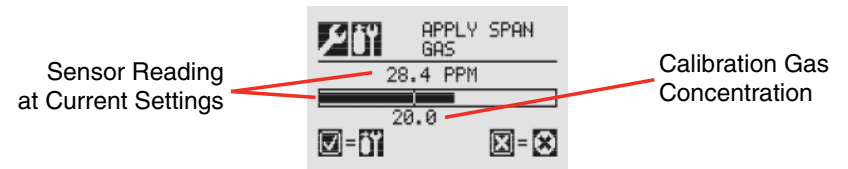

Figure 8. Span Calibration Screen

3. Apply the span gas. As the sensor detects the gas and the concentration increases, the values displayed will reflect the changing concentration. When the concentration values are stable select to perform the span. The Span Calibration process also determines whether the sensor is within the

proper range to accurately detect the target gas.

Selecting will cancel the span calibration and return to the Gas Calibration Menu.

- When the sensor has completed the calibration and the span algorithms have determined that it is within range, the Span Passed screen will appear.

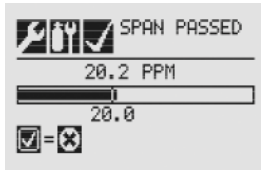

Figure 9. Span Passed Screen

If the calibration is not successful, the Span Failed screen will display. Selecting will return to the Span Concentration screen to begin the span calibration again. Selecting will exit Span Calibration and return to the Gas Calibration Menu.

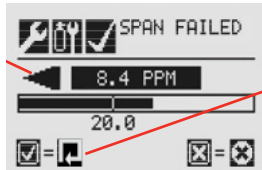

Figure 10. Span Calibration Failed

Once the Zero Gas and Span Gas calibrations are completed successfully, the user will be prompted to

- exit with inhibit off,
- exit with inhibit on, or
- not exit.



Figure 11. Exiting Zero Gas and Span Gas calibrations

WARNING

While XNX is in Inhibit Mode, alarms are silenced. This will prevent an actual gas event from being reported. Inhibit Mode must be reset after testing or maintenance activities.

6.3 Verifying mA Settings

The mA levels output for inhibiting alarms during maintenance/testing, warnings triggered by the XNX, overrange conditions, Beam Blocked and Low Signal for the Searchpoint Optima Plus and Searchline Excel gas detectors must be verified.

- From the Main Menu, select the Configure Menu (). From the Configure Menu, select mA Levels.



Figure 12. mA Levels Menu

- Use the switches to move to the mA output to be changed and use to select it.



Figure 13. Set mA Levels for Warning

- Refer to Table 6 for the mA levels. If the values do not match the values in the table, proceed to step #4 to adjust the values.

NOTE

If the values for the faults and warnings have been changed from the default settings since installation, ensure the current output matches those changed values.

Table 3. Set mA Levels

Signal*		Output (mA)		
		Default	Min	Max
I	Inhibit	2.0 mA	1.0	3.5
W	Warning	3.0 mA	1.0	3.5
O	Overrange	21.0 mA	20	22
B**	Beam Blocked	1.0 mA	1.0	4.0
L**	Low Signal	1.0 mA	1.0	4.0
*Faults are set to 1 mA and are not user-selectable				
**Beam blocked and Low Signal apply only to Excel sensors.				

- Using the switches, increment or decrement the value until the desired value appears. Then use to confirm the value and move to the next setting. Repeat for each setting that must be changed.

The available output range for Inhibit, Warning, Beam Blocked and Low Signal is from 1.0 to 4.0 mA and for an overrange condition, the range is 20.0 to 22.0 mA. Refer to Section 5 Warnings/Faults in the XNX Technical Manual for more information.

- Once all changes have been made, use the switches to move to the '✓' and use on the front panel to save the settings.



Figure 14. mA Settings Saved

NOTE:

If '✓' is not selected, none of the changes will be saved.

6.4 Testing

6.4.1 Fault and Alarm State

The mA output of the faults and alarm states should be simulated and the current output at the controller end should be within tolerance. Refer to Table 6 for the current values for the fault and alarm states.

- From the Test Menu, select Alarm/Fault Simulation.



Figure 15. Alarm/Fault Simulation Screen

- Figure 16 shows the menu choices simulating Alarm 1, Alarm 2, Warning, or a Fault. Selecting the return arrow icon will display the Alarms/Fault Reset Menu.



Figure 16. Alarm/Fault Simulation Menu

- Selecting an alarm level to simulate will activate a

confirmation screen.



Figure 17. Confirmation

Selecting will simulate the selected alarm. If the is selected, the simulation is aborted.

- To simulate a Warning or Fault from the XNX, select the appropriate icon from the menu.

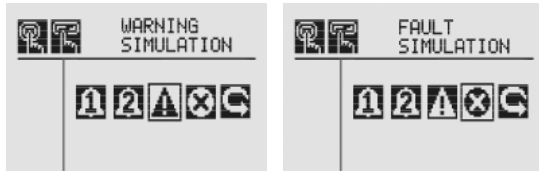

Figure 18. Warning and Fault Simulation Screens

- As in an alarm simulation, a confirmation screen will appear. Selecting will simulate a warning or fault from the XNX. If is selected, the simulation is aborted.

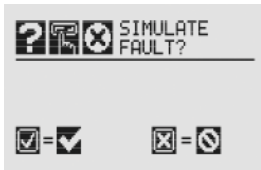

Figure 19. Fault Simulation Confirmation

- Use Alarm/Fault Reset to reset alarms, faults or warnings generated by the simulation.



Figure 20. Alarm/Fault Reset Screen

As in an alarm simulation, a confirmation screen will appear.



Figure 21. Alarm/Fault Reset Confirmation Screen

Selecting will reset all alarms, faults or warnings generated by the simulation. If is selected, the simulation continues.



CAUTION

The alarms and faults generated by the simulation will not be cleared from the XNX until alarms/faults are reset. Failure to reset the alarms/faults upon exiting the simulation keeps the relays and LEDs in alarm/fault mode.

6.4.2 Gas Verification

To verify the mA output of Zero Gas and Calibration, refer to [6.1.2](#) and [6.1.3](#).

A different bottle of calibration gas and/or zero gas should be used to verify the results.

This page is intentionally left blank

Find out more

www.sps.honeywell.com

Contact Honeywell Analytics:

Europe, Middle East, Africa

Life Safety Distribution GmbH

Tel: 00800 333 222 44 (Freephone no.)

Tel: +41 (0)44 943 4380 (Alternative no.)

Middle East Tel: +971 4 450 5800 (Fixed Gas Detection)

Middle East Tel: +971 4 450 5852 (Portable Gas Detection)

gasdetection@honeywell.com

Americas

Honeywell Analytics Inc.

Tel: +1 847 955 8200

Toll free: +1 800 538 0363

detectgas@honeywell.com

Asia Pacific

Honeywell Analytics Asia Pacific Co Ltd

Tel: +82 (0) 2 6909 0300

India Tel: +91 124 4752700

China Tel: +86 10 5885 8788-3000

analytics.ap@honeywell.com

Technical Services

EMEA: HAexpert@honeywell.com

US: ha.us.service@honeywell.com

AP: ha.ap.service@honeywell.com

www.sps.honeywell.com

Please Note:

While every effort has been made to ensure accuracy in this publication, no responsibility can be accepted for errors or omissions. Data may change, as well as legislation, and you are strongly advised to obtain copies of the most recently issued regulations, standards and guidelines. This publication is not intended to form the basis of a contract.

1998-0808

Revision 6 Nov 2021

© 2021 Honeywell Analytics

Honeywell