

# NETWORK VIDEO RECORDER

Quick Guide

ARN-410S/ARN-810S/ARN-1610S







## Package Contents





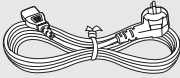
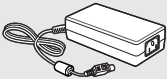
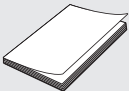

- The appearance of the components may differ from the image shown.
- Accessory category and quantity may differ depending on sales region.
- For some regions, HDD is not pre-installed. HDD Fixing Screw, SATA Cable quantity vary depending on the model.

### ARN-410S/ARN-810S

		
Recorder	Mouse	Power Cable
		
Power Adaptor	Quick Guide	HDD Fixing Screw (4 ea) (For models having no installed HDD)
		
SATA Power Cable (For models having no installed HDD)		

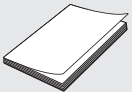
### ARN-1610S

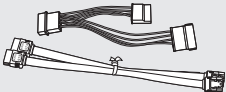
		
Recorder	Mouse	Power Cable
		
Quick Guide	HDD Fixing Screw (8 ea) (For models having no installed HDD)	SATA Power Cable (For models having no installed HDD)

#### CAUTION

- RISK OF EXPLOSION IF BATTERY IS REPLACED BY AN INCORRECT TYPE. DISPOSE OF USED BATTERIES ACCORDING TO THE INSTRUCTIONS.
- Do not ingest battery, Chemical Burn Hazard.
- This product contains a coin / button cell battery. If the coin / button cell battery is swallowed, it can cause severe internal burns in just 2 hours and can lead to death.
- Keep new and used batteries away from children. If the battery compartment does not close securely, stop using the product and keep it away from children. If you think batteries might have been swallowed or placed inside any part or the body, seek immediate medical attention.

#### ATTENTION

- IL Y A RISQUE D'EXPLOSION SI LA BATTERIE EST REMPLACÉE PAR UNE BATTERIE DE TYPE INCORRECT. METTRE AU REBUT LES BATTERIES USAGÉES CONFORMÉMENT AUX INSTRUCTIONS.
- Ne pas ingérer la pile, risque de brûlure chimique.
- Ce produit contient une pile de type bouton/pièce de monnaie. Si la pile de type bouton/pièce de monnaie est avalée, elle peut causer de graves brûlures internes en seulement 2 heures et peut entraîner la mort.
- Gardez les piles neuves et usagées hors de portée des enfants. Si le compartiment de la pile ne se ferme pas correctement, cessez d'utiliser le produit et gardez-le d'atteinte des enfants. Si vous suspectez que des piles ont été avalées ou insérées dans une partie du corps, consultez un médecin sans tarder.

## Installing the HDD

- ! ■ If you are adding a new or previously used HDD to this product in addition to the HDD(s) originally installed, format the new HDD manually in the set before use.
- If you wish to replace or add an HDD, contact your dealer or our customer service first.

### ARN-1610S

- 1** Loosen the screws on the side and back and slide the cover back to remove it.

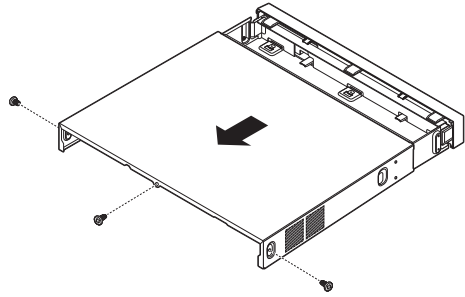

- 2** Connect the SATA/power cable of the hard disk to the connector of the main board.

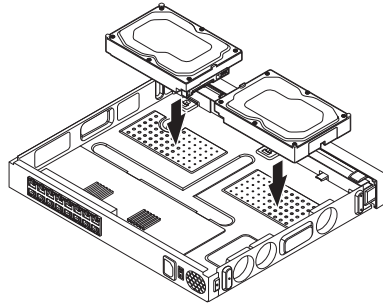

- ! ■ Gently press the connector before removing the HDD. Do not force to pull the cable.

- 3** Use the screws to fix the hard disk to the bottom of the recorder.

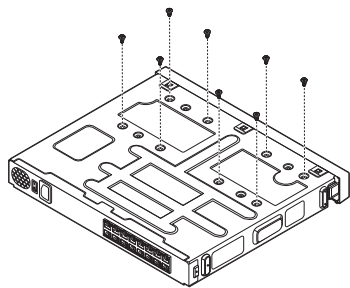

- 4** Make sure that there is no problem in the connection port and routing inside the recorder, and then fix it using screws after closing the cover.
- When closing the cover, be careful not to damage the cable.

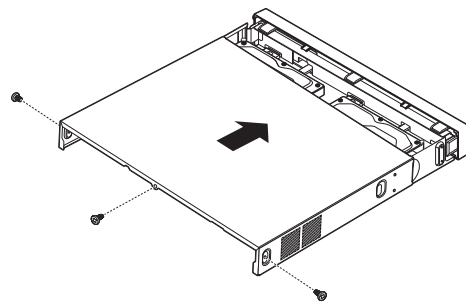

### ARN-410S/ARN-810S

- 1** Loosen the screws on the back and slide the cover back to remove it.

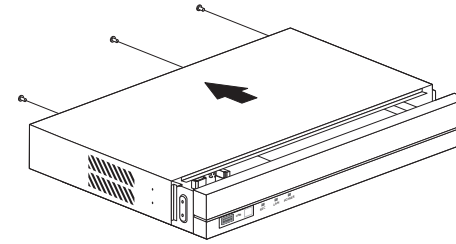

- 2** Connect the SATA/power cable of the hard disk to the connector of the main board.

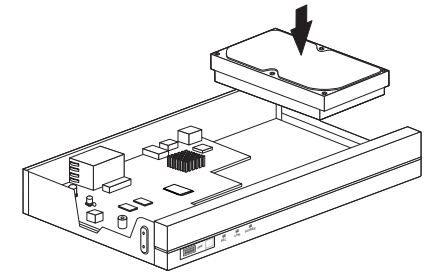

- ! ■ Gently press the connector before removing the HDD. Do not force to pull the cable.

- 3** Use the screws to fix the hard disk to the bottom of the recorder.

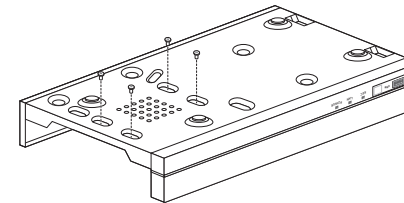

- 4** Make sure that there is no problem in the connection port and routing inside the recorder, and then fix it using screws after closing the cover.
- When closing the cover, be careful not to damage the cable.

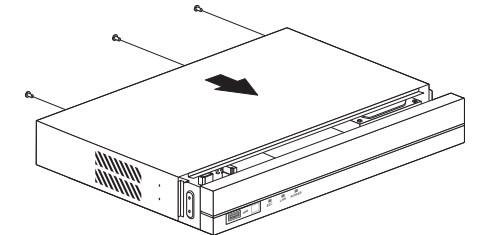

## Using Product Information

You can check the product information/manual/firmware information/FAQ/HDD compatibility list on the homepage or mobile web of your smartphone.

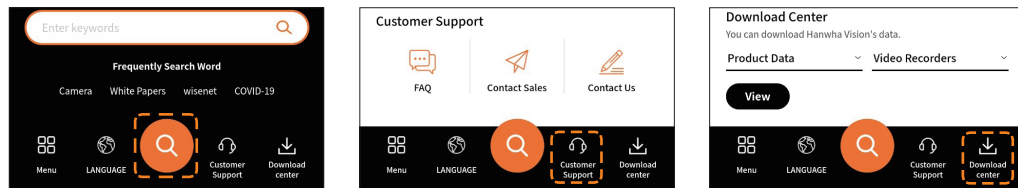

## Connecting to a Network Using a Router

If you want to add 1-3 PCs and recorders in an environment using xDSL/Cable modem, you can use the router with only one Internet line.

This guide is an installation guide for network beginners. Follow the instructions to set up your router, local PC, and recorder.

### Connecting the cable

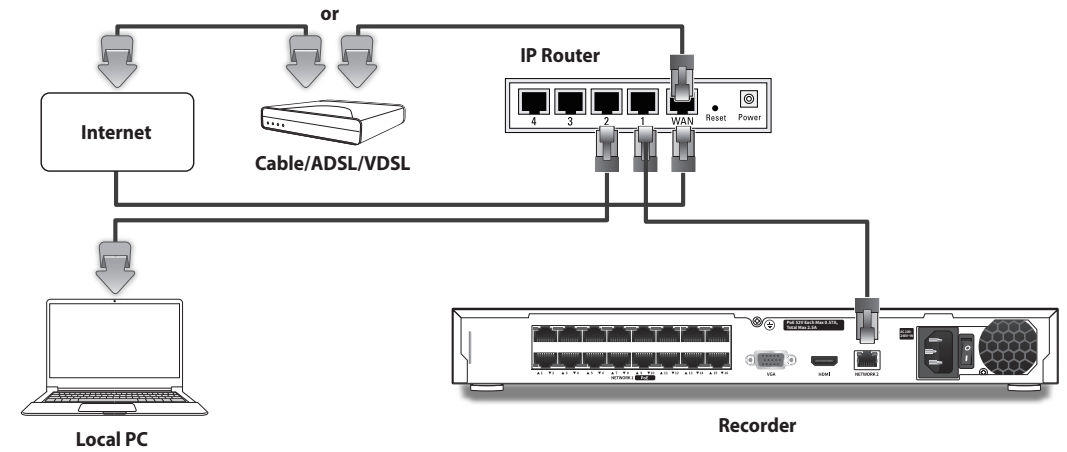

### Connecting a router with PC

 Refer to the router's user manual.

### Connecting a recorder and a router

Move to **<IP & Port>** of the Recorder **<Network>** Setting menu, and set the **1 <IP address>** and **2 <Gateway>** in **<Setup>**.

※ The **<Default gateway>** checked in the [cmd.exe] window of the local PC and the **<Gateway>** of the recorder must be the same.

※ The first three numbers of the recorder **<IP address>** should match the first three of the **<Default gateway>** checked in the [cmd.exe] window of the local PC.

```

Microsoft Windows [Version 10.0.18362.329]
(c) 2019 Microsoft Corporation. All rights reserved.

C:\Users\%User%>ipconfig

Windows IP Configuration

Ethernet adapter Ethernet 2:

    Connection-specific DNS Suffix  . : kornet
    IPv4 Address. . . . . : 192.168.219.192
    Subnet Mask . . . . . : 255.255.255.0
    Default Gateway . . . . . : 192.168.219.1
  
```

<cmd screen>

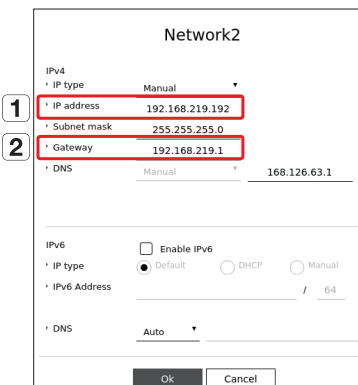

<ex. Recorder screen>



Hanwha Vision cares for the environment at all product manufacturing stages, and is taking measures to provide customers with more environmentally friendly products. The Eco mark represents Hanwha Vision's devotion to creating environmentally friendly products, and indicates that the product satisfies the EU RoHS Directive.

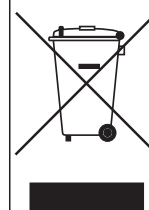

### Correct Disposal of This Product (Waste Electrical & Electronic Equipment)

(Applicable in the European Union and other European countries with separate collection systems)

This marking on the product, accessories or literature indicates that the product and its electronic accessories (e.g. charger, headset, USB cable) should not be disposed of with other household waste at the end of their working life. To prevent possible harm to the environment or human health from uncontrolled waste disposal, please separate these items from other types of waste and recycle them responsibly to promote the sustainable reuse of material resources.

Household users should contact either the retailer where they purchased this product, or their local government office, for details of where and how they can take these items for environmentally safe recycling.

Business users should contact their supplier and check the terms and conditions of the purchase contract. This product and its electronic accessories should not be mixed with other commercial wastes for disposal.



### Correct disposal of batteries in this product

(Applicable in the European Union and other European countries with separate battery return systems.)

This marking on the battery, manual or packaging indicates that the batteries in this product should not be disposed of with other household waste at the end of their working life. Where marked, the chemical symbols Hg, Cd or Pb indicate that the battery contains mercury, cadmium or lead above the reference levels in EC Directive 2006/66. If batteries are not properly disposed of, these substances can cause harm to human health or the environment.

To protect natural resources and to promote material reuse, please separate batteries from other types of waste and recycle them through your local, free battery return system.

