



Network Camera

Quick Guide

DC-D4217RX

Powered by **Direct IP**®

Safety Precautions

WARNING

RISK OF ELECTRIC SHOCK
DO NOT OPEN

WARNING: TO REDUCE THE RISK OF ELECTRIC SHOCK,
DO NOT REMOVE COVER (OR BACK). NO USER-SERVICEABLE PARTS INSIDE.
REFER SERVICING TO QUALIFIED SERVICE PERSONNEL.

Important Safeguards

1. Read Instructions

All the safety and operating instructions should be read before the appliance is operated.

2. Retain Instructions

The safety and operating instructions should be retained for future reference.

3. Cleaning

Unplug this equipment from the wall outlet before cleaning it. Do not use liquid aerosol cleaners. Use a damp soft cloth for cleaning.

4. Attachments

Never add any attachments and/or equipment without the approval of the manufacturer as such additions may result in the risk of fire, electric shock or other personal injury.

5. Water and/or Moisture

Do not use this equipment near water or in contact with water.

6. Placing and Accessories

Do not place this equipment on an wall or ceiling that is not strong enough to sustain the camera. The equipment may fall, causing serious injury to a child or adult, and serious damage to the equipment. Wall or shelf mounting should follow the manufacturer's instructions, and should use a mounting kit approved by the manufacturer.



This equipment and cart combination should be moved with care. Quick stops, excessive force, and uneven surfaces may cause the equipment and cart combination to overturn.

Do not place this equipment in an enclosed space. Sufficient ventilation is required to prevent an increase in ambient temperature which can cause malfunction or the risk of fire.

7. Power Sources

This equipment should be operated only from the type of power source indicated on the marking label. If you are not sure of the type of power, please consult your equipment dealer or local power company.

You may want to install a UPS (Uninterruptible Power Supply) system for safe operation in order to prevent damage caused by an unexpected power stoppage. Any questions concerning UPS, consult your UPS retailer.

This equipment should be remain readily operable.

8. Power Cord

Operator or installer must remove power and TNT connections before handling the equipment.

9. Lightning

For added protection for this equipment during a lightning storm, or when it is left unattended and unused for long periods of time, unplug it from the wall outlet and disconnect the antenna or cable system. This will prevent damage to the equipment due to lightning and power-line surges. If thunder or lightning is common where the equipment is installed, use a surge protection device.

10. Overloading

Do not overload wall outlets and extension cords as this can result in the risk of fire or electric shock.

11. Objects and Liquids

Never push objects of any kind through openings of this equipment as they may touch dangerous voltage points or short out parts that could result in a fire or electric shock. Never spill liquid of any kind on the equipment.

12. Servicing

Do not attempt to service this equipment yourself. Refer all servicing to qualified service personnel.

13. Damage requiring Service

Unplug this equipment from the wall outlet and refer servicing to qualified service personnel under the following conditions:

- When the power-supply cord or the plug has been damaged.
- If liquid is spilled, or objects have hit the equipment.
- If the equipment has been exposed to rain or water.
- If the equipment does not operate normally by following the operating instructions, adjust only those controls that are covered by the operating instructions as an improper adjustment of other controls may result in damage and will often require extensive work by a qualified technician to restore the equipment to its normal operation.
- If the equipment has been dropped, or the cabinet damaged.
- When the equipment exhibits a distinct change in performance — this indicates a need for service.

14. Replacement Parts

When replacement parts are required, be sure the service technician has used replacement parts specified by the manufacturer or that have the same characteristics as the original part. Unauthorized substitutions may result in fire, electric shock or other hazards.

15. Safety Check

Upon completion of any service or repairs to this equipment, ask the service technician to perform safety checks to determine that the equipment is in proper operating condition.

16. Field Installation

This installation should be made by a qualified service person and should conform to all local codes.

17. Tmra

A manufacturer's maximum recommended ambient temperature (Tmra) for the equipment must be specified so that the customer and installer may determine a suitable maximum operating environment for the equipment.

FCC Compliance Statement

THIS EQUIPMENT HAS BEEN TESTED AND FOUND TO COMPLY WITH THE LIMITS FOR A CLASS A DIGITAL DEVICE, PURSUANT TO PART 15 OF THE FCC RULES. THESE LIMITS ARE DESIGNED TO PROVIDE REASONABLE PROTECTION AGAINST HARMFUL INTERFERENCE WHEN THE EQUIPMENT IS OPERATED IN A COMMERCIAL ENVIRONMENT. THIS EQUIPMENT GENERATES, USES, AND CAN RADIATE RADIO FREQUENCY ENERGY AND IF NOT INSTALLED AND USED IN ACCORDANCE WITH THE INSTRUCTION MANUAL, MAY CAUSE HARMFUL INTERFERENCE TO RADIO COMMUNICATIONS. OPERATION OF THIS EQUIPMENT IN A RESIDENTIAL AREA IS LIKELY TO CAUSE HARMFUL INTERFERENCE, IN WHICH CASE USERS WILL BE REQUIRED TO CORRECT THE INTERFERENCE AT THEIR OWN EXPENSE.

WARNING: CHANGES OR MODIFICATIONS NOT EXPRESSLY APPROVED BY THE PARTY RESPONSIBLE FOR COMPLIANCE COULD VOID THE USER'S AUTHORITY TO OPERATE THE EQUIPMENT. THIS CLASS OF DIGITAL APPARATUS MEETS ALL REQUIREMENTS OF THE CANADIAN INTERFERENCE CAUSING EQUIPMENT REGULATIONS.

WEEE (Waste Electrical & Electronic Equipment)

Correct Disposal of This Product
(Applicable in the European Union and other European countries with separate collection systems)



This marking shown on the product or its literature, indicates that it should not be disposed with other household wastes at the end of its working life. To prevent possible harm to the environment or human health from uncontrolled waste disposal, please separate this from other types of wastes and recycle it responsibly to promote the sustainable reuse of material resources.

Household users should contact either the retailer where they purchased this product, or their local government office, for details of where and how they can take this item for environmentally safe recycling.

Business users should contact their supplier and check the terms and conditions of the purchase contract. This product should not be mixed with other commercial wastes for disposal.

Safety Symbols

Symbol	Publication	Description
	IEC60417, No.5031	Direct current

Copyright

© 2021 IDIS Co., Ltd.

IDIS Co., Ltd. reserves all rights concerning this document.

Use or duplication of this document in part or whole without the prior consent of IDIS Co., Ltd. is strictly prohibited.

Contents of this document are subject to change without prior notice for reasons such as functionality enhancements.

Registered Trademarks

IDIS is a registered trademark of IDIS Co., Ltd.

Other company and product names are registered trademarks of their respective owners.

The software included in this product contains some Open Sources. You may obtain the corresponding source code which we have to distribute according to the license policy. For more information, refer to **System > General** page. This product includes software developed by the University of California, Berkeley and its contributors, and software developed by the OpenSSL Project for use in the OpenSSL Toolkit (<http://www.openssl.org/>). Also, this product includes cryptographic software written by Eric Young (ey@cryptsoft.com).

Covered by one or more claims of the patents listed at patentlist.accessadvance.com

Risk Group1



WARNING IR emitted from this product. Do not stare at operating lamp

Product tested against IEC62471

Warning: This product emits infrared light. Do not look into the IR LED.

Accessories

Upon purchasing the product, check inside the box to make sure all the following accessories are included. Some parts may differ depending on the situation.

Item

Network Camera
Quick Guide
Guide Pattern
Screws

Please download software (IDIS Discovery, IDIS Center, IDIS Solution Suite Compact) and product manual from this link :
- IDIS Website (www.idisglobal.com)
- Search IDIS Discovery, IDIS Center, IDIS Solution Suite Compact.

Overview

- Product color and design may vary depending on the model.
- For more details on each part name, refer to the manual.

Dome Cover

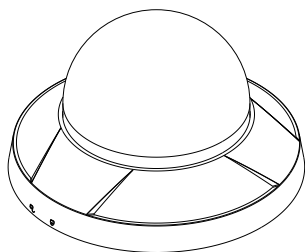

1	Lens	5	Bottom Cover
2	Network Port	6	IR LED
3	Wall/Ceiling Installation Hole	7	Factory Reset Button
4	Cable Access Hole	8	Status LED

Camera Installation

Removing the Dome Cover

- 1 Turn the dome cover counterclockwise.

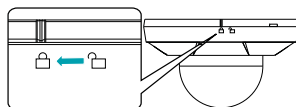

Body

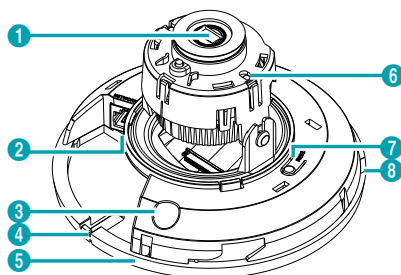

- 2 Remove the dome cover.

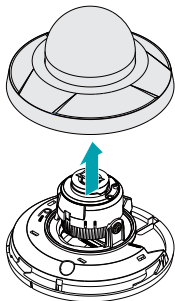

Installation

- ✓ Use the provided guide pattern to check the distance between the screw holes if necessary.

- 1 Use the screws, anchor provided with the camera to secure the body on a wall or a ceiling.

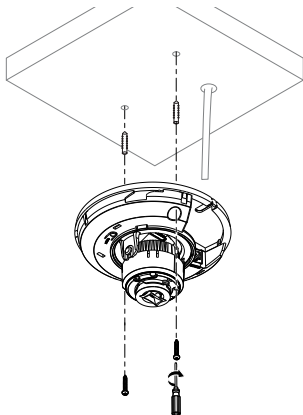

- 2 Connect external devices and the network cable.
- 3 Adjust the angle. For more details, refer to **Angle Adjustment**.

Closing the Dome Cover

Attach the dome cover to the bottom cover. Turn the dome cover clockwise to fasten the dome cover.

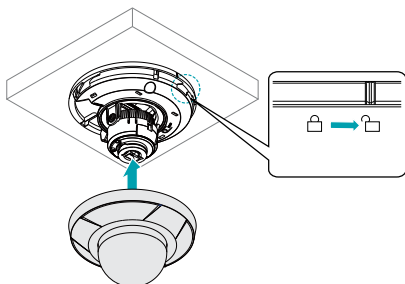

Angle Adjustment

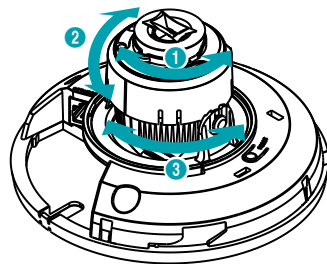

1	Lens Rotation	3	Horizontal Rotation
2	Vertical Rotation		

Specifications

Operating Temperature	-10°C ~ 50°C (14°F ~ 122°F)
Boot Up Temperature	0°C ~ 50°C (32°F ~ 122°F)
Operating Humidity	0% ~ 90%
Power Source	PoE (IEEE 802.3af Class 2)
Power Consumption	PoE, IEEE 802.3af(Class2),3.8W
Approval	FCC, CE
External Dimensions (Ø x H)	130mm x 81.4mm (5.11" x 3.2")
Weight (Main Unit)	0.242kg (0.053lb)

- **DirectIP NVR makes it easy to use cameras without extra network configurations. Each camera can be controlled via the DirectIP™ NVR setup menu, without any PC.**
 - For detailed camera settings, please see the camera setting pages of DirectIP™ NVR manual.
- **To use your camera with non-DirectIP system (e.g. other NVR or VMS), refer to the camera manual and it can be downloaded from our website: www.idisglobal.com.**



IDIS Co., Ltd.

For more information, please visit
www.idisglobal.com