

## Traffic Video Unit-Steel hoop 67/127

### Feature

- Galvanized steel sheet and steel material with surface spray treatment
- Can be used for radar, supplement light, and traffic unit.



### Dimension

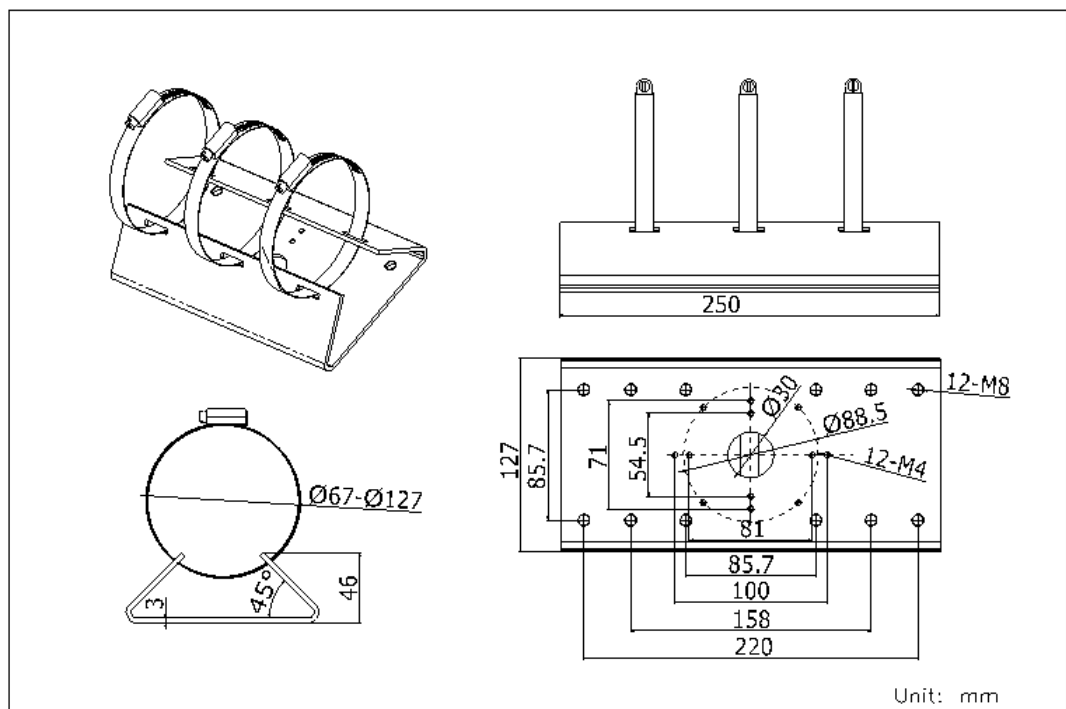

### Available Model

Steel hoop 67/127

### Parameter

Model	Steel hoop 67/127
Parameters	Vertical Pole Mounting Bracket
Appearance	PLG
Material	Galvanized steel sheet and Steel(sus304)
Dimension	250 mm × 127 mm × 46mm
Weight	1.5 Kg

### Note

- The bracket should be installed on the cross bar.
- The cross bar must be capable of supporting at least 3 times as much as the total weight of traffic unit and the bracket.