

User's Manual



RS232/RS422/RS485

Serial Device Server

▶ **ICS-110 / ICS-115A / ICS-120**



Trademarks

Copyright © PLANET Technology Corp. 2020.

Contents are subject to revision without prior notice.

PLANET is a registered trademark of PLANET Technology Corp. All other trademarks belong to their respective owners.

Disclaimer

PLANET Technology does not warrant that the hardware will work properly in all environments and applications, and makes no warranty and representation, either implied or expressed, with respect to the quality, performance, merchantability, or fitness for a particular purpose. PLANET has made every effort to ensure that this User's Manual is accurate; PLANET disclaims liability for any inaccuracies or omissions that may have occurred.

Information in this User's Manual is subject to change without notice and does not represent a commitment on the part of PLANET. PLANET assumes no responsibility for any inaccuracies that may be contained in this User's Manual. PLANET makes no commitment to update or keep current the information in this User's Manual, and reserves the right to make improvements to this User's Manual and/or to the products described in this User's Manual, at any time without notice.

If you find information in this manual that is incorrect, misleading, or incomplete, we would appreciate your comments and suggestions.

FCC Warning

This equipment has been tested and found to comply with the limits for a Class A digital device, pursuant to Part 15 of the FCC Rules. These limits are designed to provide reasonable protection against harmful interference when the equipment is operated in a commercial environment. This equipment generates, uses, and can radiate radio frequency energy and, if not installed and used in accordance with the Instruction manual, may cause harmful interference to radio communications. Operation of this equipment in a residential area is likely to cause harmful interference in which case the user will be required to correct the interference at his own expense.

CE Mark Warning

This device is compliant with Class A of CISPR 32.

In a residential environment this device may cause radio interference.

Energy Saving Note of the Device

This power required device does not support Standby mode operation. For energy saving, please remove the power cable to disconnect the device from the power circuit. In view of saving the energy and reducing the unnecessary power consumption, it is strongly suggested to remove the power connection for the device if this device is not intended to be active.

WEEE Warning



To avoid the potential effects on the environment and human health as a result of the presence of hazardous substances in electrical and electronic equipment, end users of electrical and electronic equipment should understand the meaning of the crossed-out wheeled bin symbol. Do not dispose of WEEE as unsorted municipal waste and have to collect such WEEE separately.

Revision

PLANET ICS-11x Series User's Manual

Model: ICS-110 / ICS-115A / ICS-120

Revision: 1.0 (August, 2020)

Part No: EM-ICS-11x_v1.0

TABLE OF CONTENTS

1. INTRODUCTION	5
1.1 Packet Contents	5
1.2 Product Description	6
1.3 How to Use This Manual	9
1.4 Product Features	10
1.5 Product Specifications	11
2. INSTALLATION	14
2.1 Hardware Description	14
2.1.1 Physical Dimensions	14
2.1.2 Front / Top Panel	17
2.1.3 LED Indications	18
2.1.4 Rear Panel	18
2.1.5 Power Information:	19
2.1.6 Serial Port Pin Define	20
2.2 Installing the Serial Server	21
2.2.1 Installation Steps	21
2.2.2 Wall-mount Installation	22
2.2.3 Media Chassis Installation (ICS-110/115A)	23
2.2.4 Optional DIN-rail Installation	23
3. SERIAL DEVICE SERVER MANAGEMENT	25
3.1 Requirements	25
3.2 Web Management	26
3.2.1 Logging in to the Serial Server	26
3.3 Remote Management	28
3.4 PLANET Smart Discovery Utility	29
4. WEB CONFIGURATION	31
4.1 Main Web Page	34
4.2 System	36
4.2.1 System	36
4.2.2 Port	38
4.2.3 Device	39

4.2.4 Time.....	39
4.2.5 Console.....	40
4.3 Accessible IP.....	41
4.4 Network.....	42
4.5 Port Config.....	44
4.5.1 Serial setup.....	45
4.5.2 Operation mode.....	46
4.5.2.1 Disable mode.....	46
4.5.2.2 Remote Pair Master/Slave mode.....	47
4.5.2.3 RF2217 mode.....	49
4.5.2.4 Serial Telnet mode.....	50
4.5.2.5 TCP Server mode.....	53
4.5.2.6 TCP Client mode.....	56
4.5.2.7 UDP mode.....	58
4.5.2.8 Virtual COM mode.....	60
4.5.2.9 Modbus Converter Server mode.....	63
4.5.2.10 Modbus Converter Client mode.....	64
4.6 SNMP Setup.....	66
4.7 Maintenance.....	67
4.7.1 Change Password.....	67
4.7.2 Load Default.....	67
4.7.3 Firmware Update.....	68
4.8 Save and Restart.....	69
5. SOFTWARE VCOM UTILITY.....	70
5.1 Installing the VCOM Utility.....	70
5.2 Search Devices.....	72
5.3 COM Port Mapping.....	73

1. INTRODUCTION



Thank you for purchasing PLANET ICS-110/ICS-115A/ ICS-120 Serial Device Server. "Serial Server" is used as an alternative name in this User's Manual.

ICS-110	1-Port RS232/422/485 Serial Device Server
ICS-115A	1-Port RS232/422/485 Serial Device Server with 1-Port 100BASE-FX SFP
ICS-120	2-Port RS232/422/485 Serial Device Server

"Serial Server" mentioned in this Guide refers to the ICS-110/ICS-115A/ ICS-120.

1.1 Packet Contents

Open the box of the Serial Server and carefully unpack it. The box should contain the following items:

<p style="text-align: center;">The Serial Device Server x 1</p> 	<p style="text-align: center;">User's Manual x 1</p> 
<p style="text-align: center;">External AC-DC Power Adapter x 1</p> 	

If any of these are missing or damaged, please contact your dealer immediately; if possible, retain the carton including the original packing material, and use them again to repack the product in case there is a need to return it to us for repair.

1.2 Product Description

Cost-effective Solution for RS232/422/485 Serial-to-Ethernet Application

PLANET ICS-11x Serial Device Server series is specially designed to convert one/two RS232, RS422 or RS485 serial communication to Fast Ethernet networking to extend the network distance efficiently and inexpensively.



There are one 10/100BASE-TX RJ45 port and single-mode/multi-mode media available in the ICS-11x series and its operating temperature ranges from -10 to 60 degrees C for your network needs. The ICS-11x series is a time-saving and cost-effective solution for users and system integrators to quickly transform their serial devices into the Ethernet network with no need of replacing the existing serial devices and software system.

Convert Serial Communication to IP Networking

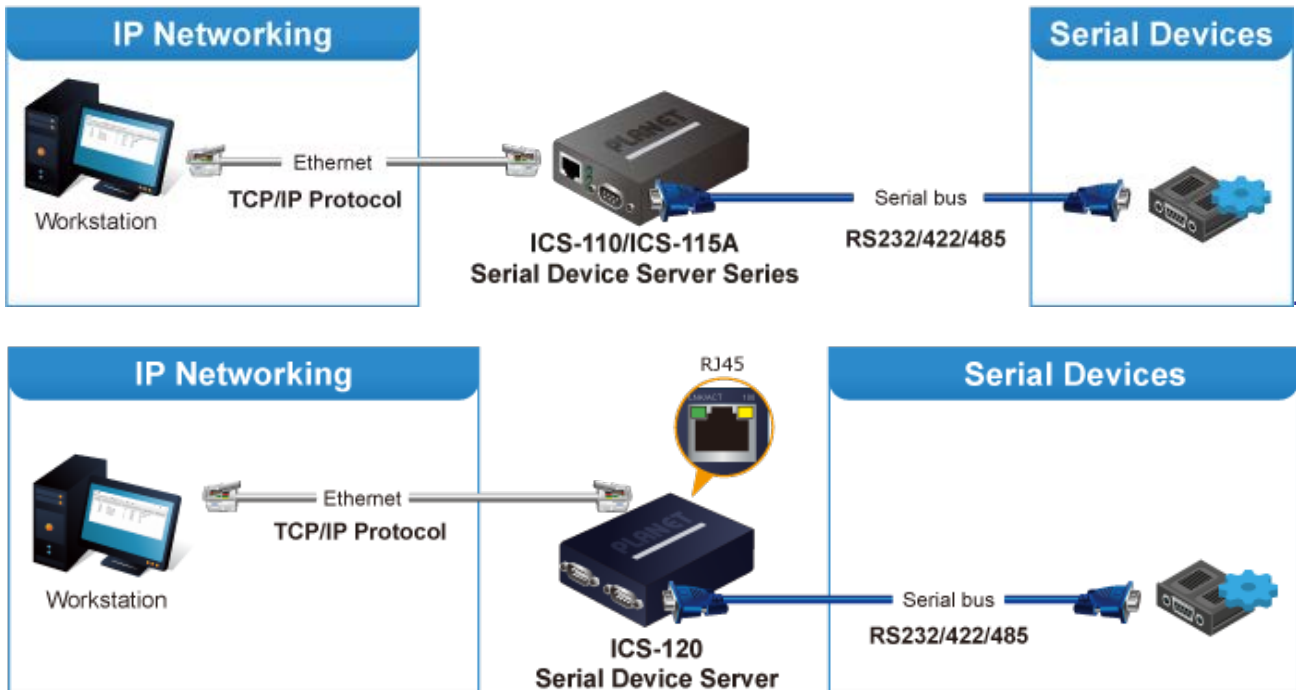

Extending Distance (Only ICS-115A)

The ICS-115A is able to extend the distance of deploying serial equipment and hosts. The selectable fiber-optic cables on the basis of distance are provided. Therefore, this product will perfectly satisfy the diverse demands while providing reliable and efficient network solutions based on the distance and budgets of installation.

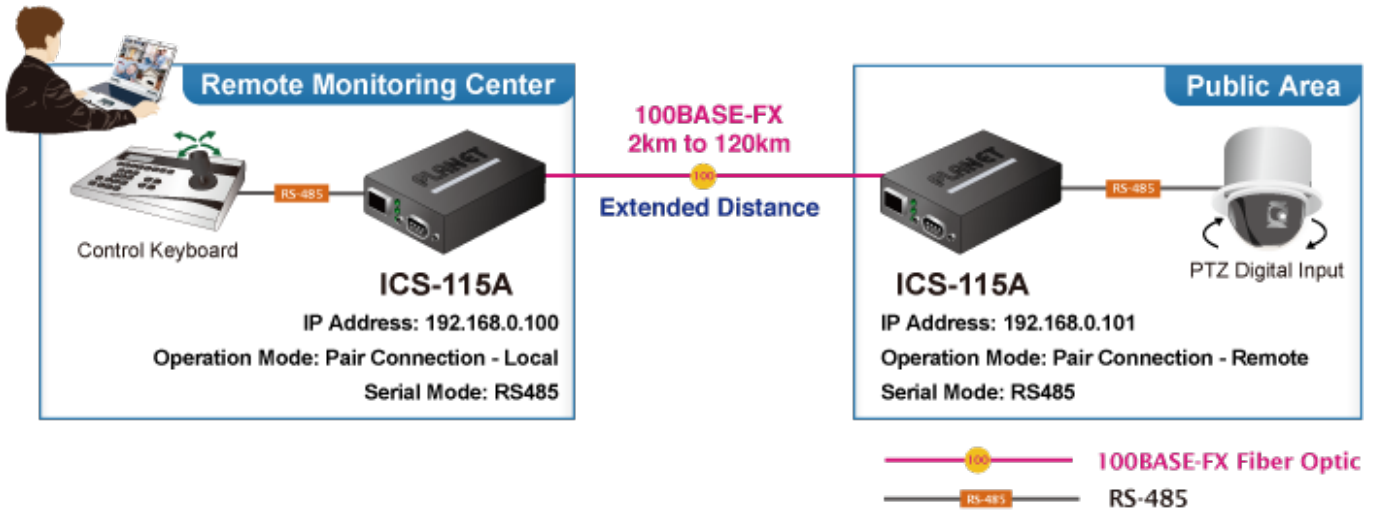

Remote Management

As the ICS-11x series provides an easy serial-to-Ethernet connectivity and connection to a TCP/IP network, the remote network system can thus be managed efficiently via its Web, telnet and VCOM management interfaces. It supports both application and serial operation modes for alarm or IP address connection, which saves the network administrator's time in detecting and locating network problems without visual inspection of the cabling and devices. Multiple connection options are available for large networking environment as well.

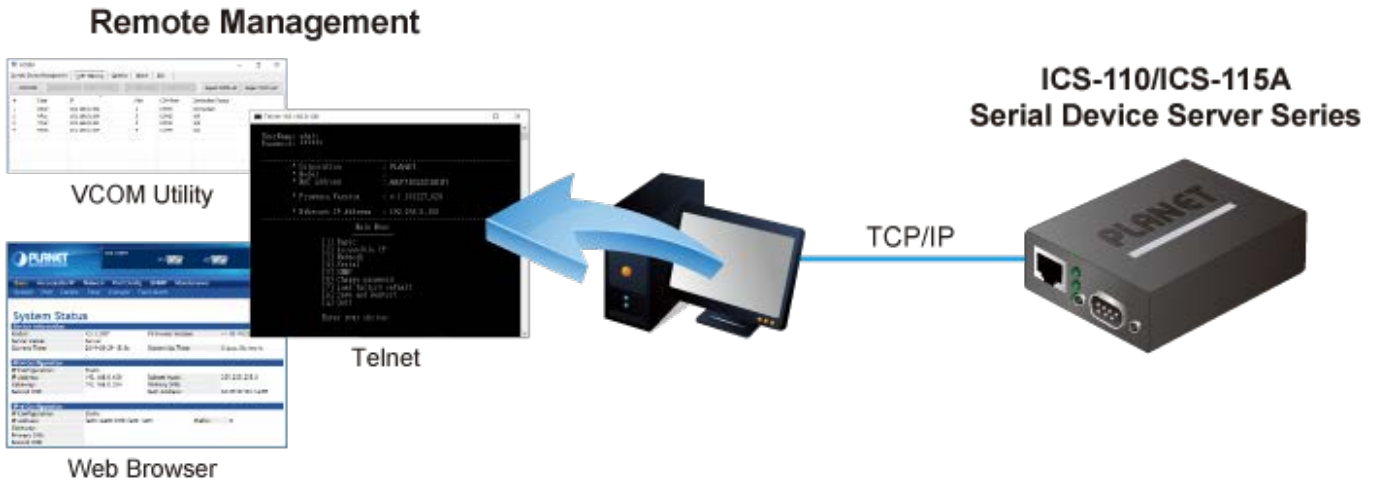

Easy Chassis Installation (Only ICS-110/115A)

The ICS-11x series can be used as a stand-alone unit or a slide-in module to PLANET Media Converter Chassis (MC-700 and MC-1500 chassis series). The media chassis can assist in providing DC power to the ICS-11x series and can be DIN-rail or wall mounted for efficient use of cabinet space, without the need of replacing the existing serial equipment and software system.

Optional installation method



Media Chassis Installation



DIN-rail Installation



Wall-mount Installation

1.3 How to Use This Manual

This User's Manual is structured as follows:

Section 2, INSTALLATION

It explains the functions of the ICS-11x Series and how to physically install the ICS-11x Series.

Section 3, SERIAL DEVICE SERVER MANAGEMENT

The chapter explains how to manage the ICS-11x Series in different ways.

Section 4, WEB CONFIGURATION

It describes how to configure by web interface.

Section 5, SOFTWARE VCOM UTILITY

It describes how to use software VCOM in the Virtual COM mode.

1.4 Product Features

➤ **Serial Interface**

- One/Two DB9 interface supports RS232, 2-wire RS485, 4-wire RS485 and RS422 operation
- Asynchronous serial data rates up to 921600bps
- Data mode includes VCOM, RFC2217, TCP Server, TCP Client, UDP, Remote Pair, Modbus converter server / client and Serial Telnet modes

➤ **Ethernet Interface**

- 1-port **10/100BASE-TX** RJ45 interface with auto MDI/MDI-X function
- 1-port **100BASE-FX** SFP slot (ICS-115A)

➤ **Management**

- IPv4 and IPv6 dual stack management
- Remote Management Interfaces
 - IP-based Web management
 - Telnet console management
 - Windows-based VCOM utility supports searching, monitoring and configuration setting
- IP NTP (Network Time Protocol)
- Standard TCP/IP interface and versatile operation modes
- Software Protocol supports ICMP, TCP/IP, UDP, HTTP server, DHCP client, Telnet server/client
- Serial Operation mode selected via management interface
- Pair Connection mode for connecting two serial devices over a network
- Allows a maximum of 4 hosts to be accessed as TCP client mode
- Firmware upgrade via HTTP protocol
- Accessible IP security control to prevent illegal users
- Event notification
 - Remote syslog server
 - SNMP trap
- DHCP client for IP address assignment
- PLANET Smart Discovery utility automatically finds the client devices on the network

➤ **Case and Installation**

- Compact size for easy Installation:
 - Standalone - Wall mountable or DIN-rail mounting (optional accessory)
 - Co-works with PLANET MC family Media Chassis (**MC-700/1500/1500R for ICS-110/115A**)
- External power adaptor 5V DC / 2A max.
- Supports 6000 VDC Ethernet ESD protection
- -10 to 60 degrees C operating temperature
- Supports extensive LED indicators for network diagnosis
- Reset button for resetting to factory default

1.5 Product Specifications

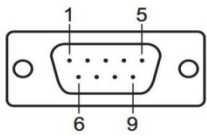
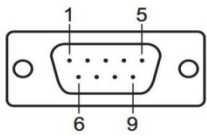
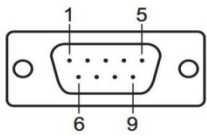
Product	ICS-110	ICS-115A	ICS-120																																										
Serial Interface																																													
Serial Port	1 x DB9 male		2 x DB9 male																																										
Serial Standards	RS232/RS422/4-wire RS485/2-wire RS485																																												
Baud Rate (Data Rate)	50bps to 921Kbps																																												
Data Bits	5, 6, 7, 8																																												
Stop Bit	1, 1.5, 2																																												
Parity Type	Odd, Even, None, Space, Mark																																												
Flow Control	RTS/CTS and DTR/DSR (RS232 only) XON/XOFF																																												
Signals	RS232: TxD, RxD, RTS, CTS, DTR, DSR, DCD, GND RS422: Tx+, Tx-, Rx+, Rx-, GND 4-wire RS485: Tx+, Tx-, Rx+, Rx-, GND 2-wire RS485: Data A (+), Data B (-), GND																																												
Pin Assignment	<table border="1"> <thead> <tr> <th>Male DB9</th> <th>Pin</th> <th>RS232</th> <th>RS422 RS485-4W</th> <th>RS485-2W</th> </tr> </thead> <tbody> <tr> <td rowspan="9">  </td> <td>1</td> <td>DCD</td> <td>TxD+</td> <td>--</td> </tr> <tr> <td>2</td> <td>RxD</td> <td>TxD-</td> <td>--</td> </tr> <tr> <td>3</td> <td>TxD</td> <td>RxD-</td> <td>Data-</td> </tr> <tr> <td>4</td> <td>DTR</td> <td>RxD+</td> <td>Data+</td> </tr> <tr> <td>5</td> <td>GND</td> <td>GND</td> <td>GND</td> </tr> <tr> <td>6</td> <td>DSR</td> <td>--</td> <td>--</td> </tr> <tr> <td>7</td> <td>RTS</td> <td>--</td> <td>--</td> </tr> <tr> <td>8</td> <td>CTS</td> <td>--</td> <td>--</td> </tr> <tr> <td>9</td> <td>--</td> <td>--</td> <td>--</td> </tr> </tbody> </table>			Male DB9	Pin	RS232	RS422 RS485-4W	RS485-2W		1	DCD	TxD+	--	2	RxD	TxD-	--	3	TxD	RxD-	Data-	4	DTR	RxD+	Data+	5	GND	GND	GND	6	DSR	--	--	7	RTS	--	--	8	CTS	--	--	9	--	--	--
Male DB9	Pin	RS232	RS422 RS485-4W	RS485-2W																																									
	1	DCD	TxD+	--																																									
	2	RxD	TxD-	--																																									
	3	TxD	RxD-	Data-																																									
	4	DTR	RxD+	Data+																																									
	5	GND	GND	GND																																									
	6	DSR	--	--																																									
	7	RTS	--	--																																									
	8	CTS	--	--																																									
	9	--	--	--																																									
Ethernet Interface																																													
Ethernet Ports	1 x RJ45	1 x SFP	1 x RJ45																																										
Standard	10/100BASE-TX	100BASE-FX	10/100BASE-TX																																										
Distance	100m	2km to 120km, vary on SFP modules	100m																																										
ESD Protection	6KV																																												
Hardware																																													
Installation	DIN-rail kit and wall-mount ear																																												
Dimensions (W x D x H)	97 x 70 x 26mm	97 x 70 x 26mm	97 x 70 x 26mm																																										
Weight	184 g	185 g	189g																																										
LED Indicators	System: Link TP/SFP Port: Link/ Active Serial Port: Active																																												
Power Requirements	External Power Adaptor 5V DC / 2A max.																																												
Power Consumption	5.5 watts (max)																																												
Mechanical	Metal																																												
Reset Button	< 5 sec: System reboot > 5 sec: Factory default																																												

Management	
Management Interfaces	Web management Telnet Console management Windows-based VCOM Utility management SNMPv1, v2c / SNMP Trap UNI-NMS monitoring PLANET Smart Discovery Utility
IP Version	IPv4 and IPv6
Operation Mode	TCP Server / TCP Client UDP Client Virtual COM RFC2217 Telnet Server Pair Connection – Remote (Slave) Pair Connection – Local (Master) Modbus converter server / client
Virtual COM Utility Platform Supports	Windows-based Only: Windows XP Windows Server 2003 Windows 7 Windows Server 2008 Windows 8 (Must install the latest version of WinPcap) Windows Server 2012 (Must install the latest version of WinPcap) Windows 10
Fault Alarm	Record: System log / SNMP trap
Time	NTP
Security	Accessible IP (white list)
SNMP	SNMP v1 and v2c
Standards Conformances	
Regulatory Compliance	FCC Part 15 Class A, CE Certification Class A
Stability Testing	IEC60068-2-32 (Free fall) IEC60068-2-27 (Shock) IEC60068-2-6 (Vibration)
Standards	IEEE 802.3 10BASE-T, IEEE 802.3u 100BASE-TX/100BASE-FX RFC 768 UDP RFC 793 TFTP RFC 791 IP RFC 792 ICMP RFC 854 Telnet RFC 958 NTP RFC 1908 SNMPv2c RFC 2068 HTTP RFC 2131 DHCP Client RFC 2732 Format for Literal IPv6 Addresses in URL's

	RFC 3315 DHCPv6 Client RFC 3513 IPv6 Addressing Architecture RFC 4443 ICMPv6 EIA/TIA RS232/422/485	
Regulatory Approval	RoHS	
Compatible Media Converter Chassis	MC-700, MC-1500, MC-1500R	N/A
Note.	Reset Button on the rear panel for resetting to factory default	
Environment		
Operating Temperature	-10 ~ 60 degrees C	
Storage Temperature	-10 ~ 70 degrees C	
Humidity	5 ~ 95% (non-condensing)	

2. INSTALLATION

This section describes the hardware features and installation of the Serial Servers' components on the desktop or rack. For easier management and control of the Serial Servers, familiarize yourself with its display indicators, and ports. Front panel illustrations in this chapter display the LED indicators. Before connecting any network device to the Serial Servers, please read this chapter completely.

2.1 Hardware Description

2.1.1 Physical Dimensions

- ICS-110: 94 x 70 x 26mm (W x D x H)

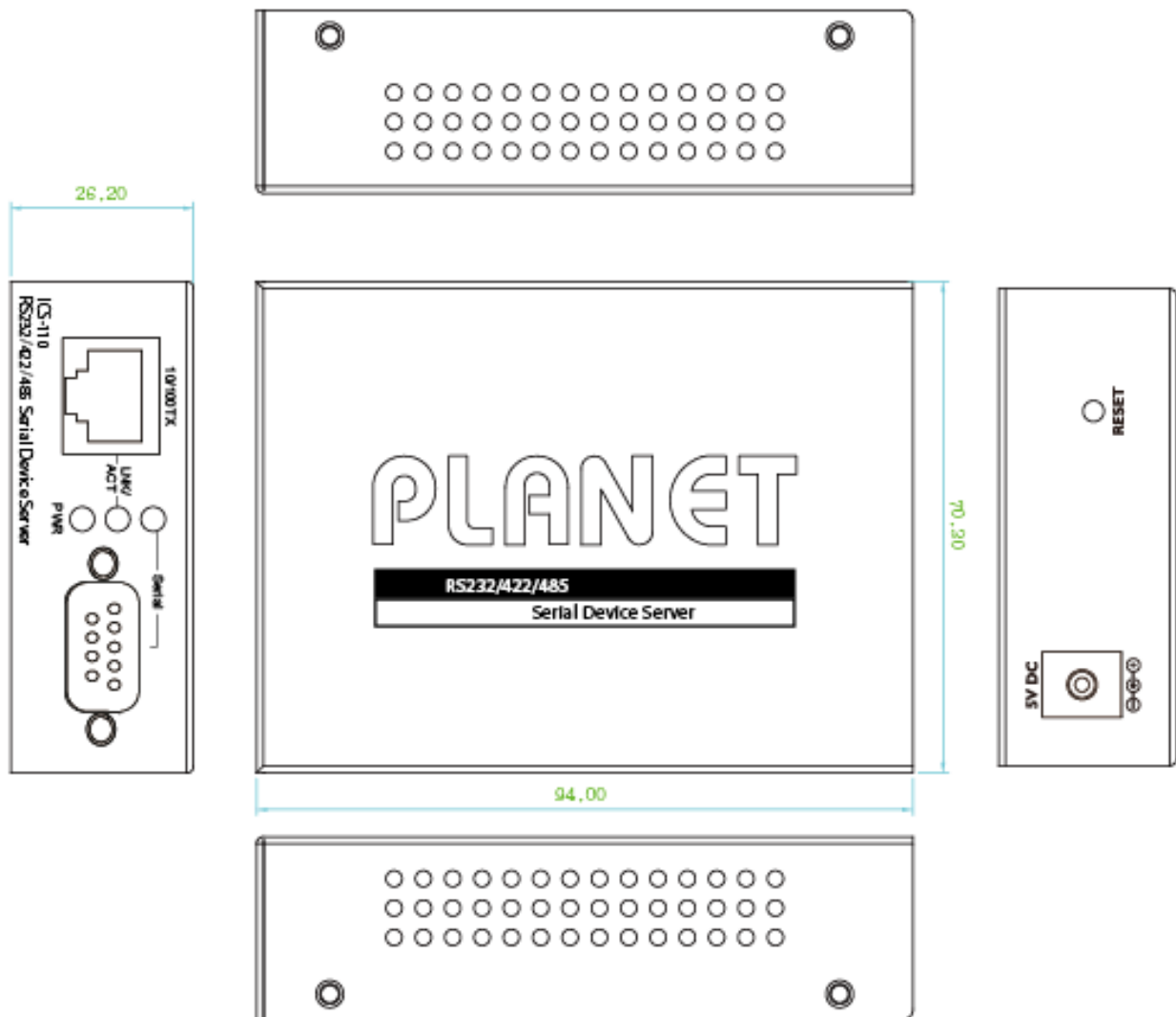

- ICS-120: 94 x 70 x 26mm (W x D x H)

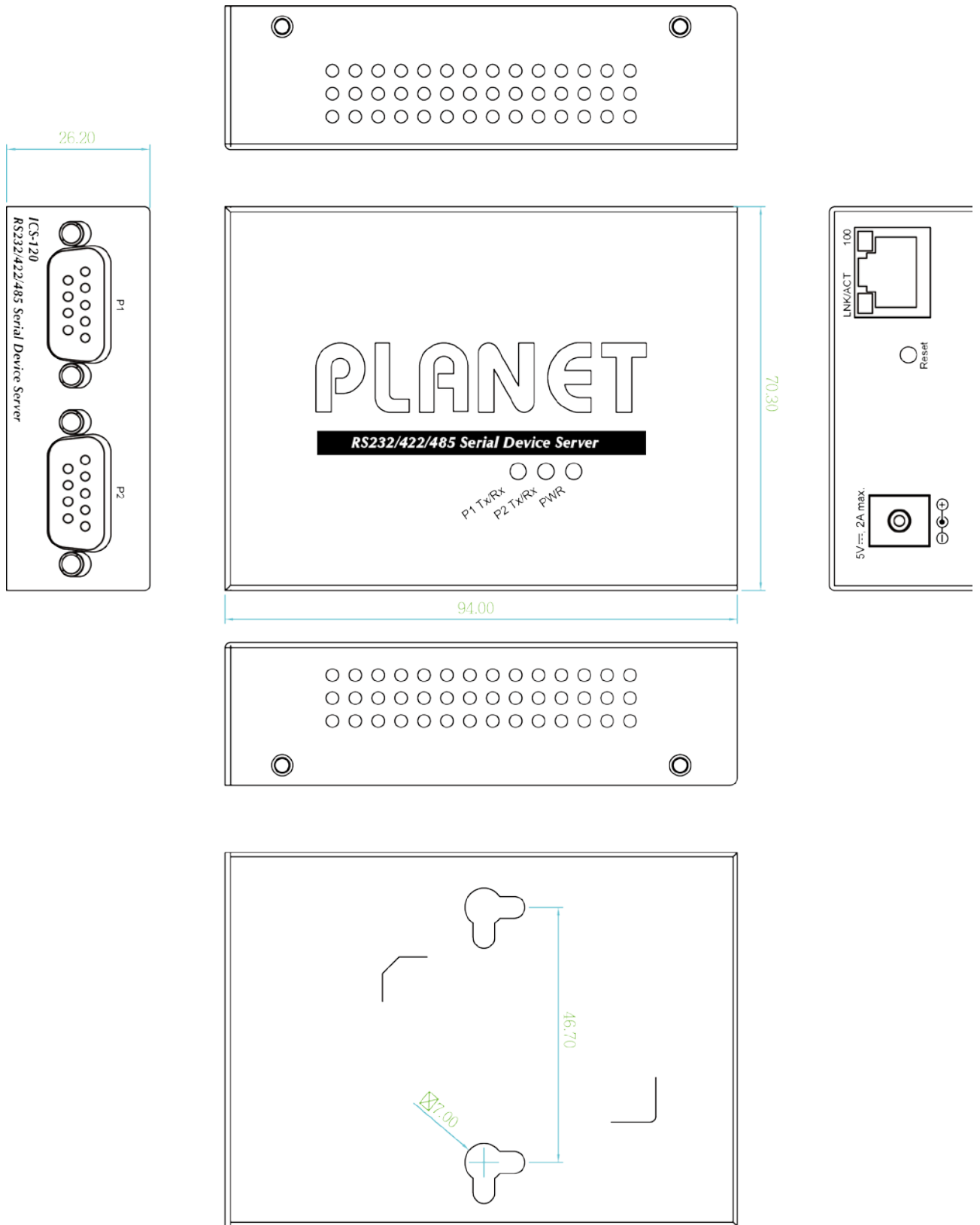

Unit: mm

2.1.2 Front / Top Panel

The front panels of the Serial Servers are shown in Figure 2-1-1.

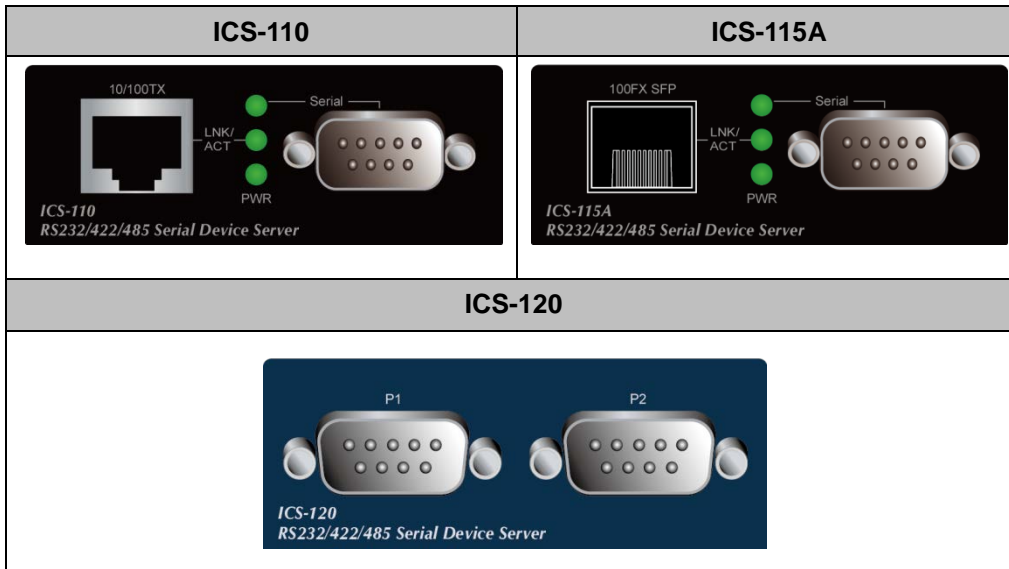

Figure 2-1-1: Front Panels of Serial Servers

The top panel of the ICS-120 is shown in Figure 2-1-2.

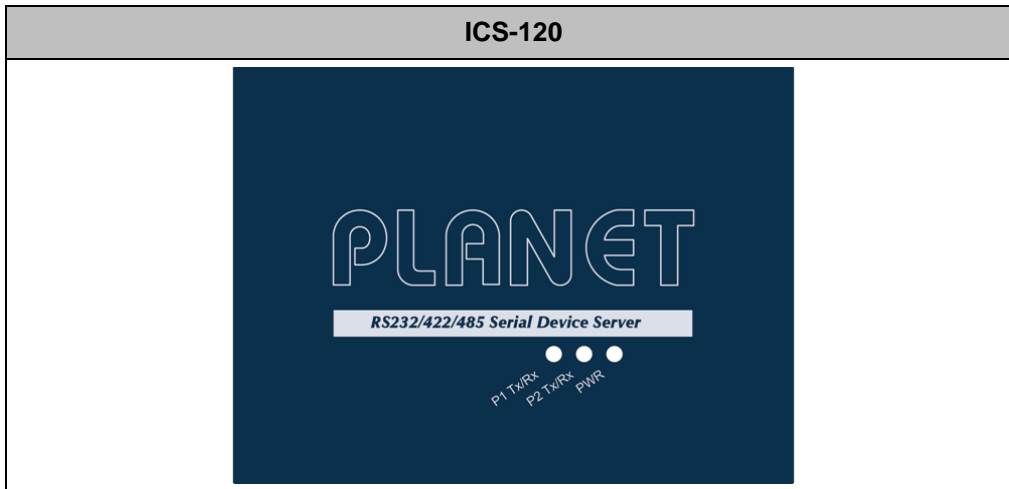

Figure 2-1-2: Top Panel of ICS-120

■ Fast TP/ SFP interface

10/100BASE-TX copper, RJ45 twisted-pair: Up to 100 meters.

100BASE-FX SFP interface, Up to 2km~120km, vary on SFP modules.

■ Serial Interface

Supports RS-232, RS-422, RS-485 2-wire and RS485 4-wire.

2.1.3 LED Indications

The front/top panel LEDs indicate the instant status of power and system status, port links and data activity; they help monitor and troubleshoot when needed.

■ **System**

LED	Color	Function	
PWR	Green	Lights	Power is activated.
Serial (TX/RX)	Green	Blinks	To indicate the Serial Port is receiving or sending data

■ **10/100BASE-TX/100BASE-FX Port**

ICS-110/115A

TP or Fiber	Green	Lights	To indicate that the Fast Ethernet port is successfully connecting to the network at 10Mbps or 100Mbps (Fiber port only 100Mbps)
		Blinks	To indicate the Fast Ethernet Port is receiving or sending data

ICS-120

TP port		Off	To indicate that the Fast Ethernet port is successfully connecting to the network at 10Mbps.
	Amber (100)	Lights	To indicate that the Fast Ethernet port is successfully connecting to the network at 100Mbps.
	Green (LNK/ACT)	Blinks	To indicate the TP Port is receiving or sending data

2.1.4 Rear Panel

The rear panels of Serial Servers consist of one DC jack, which accepts input power with 5V DC, 2A (Figure 2-1-3).

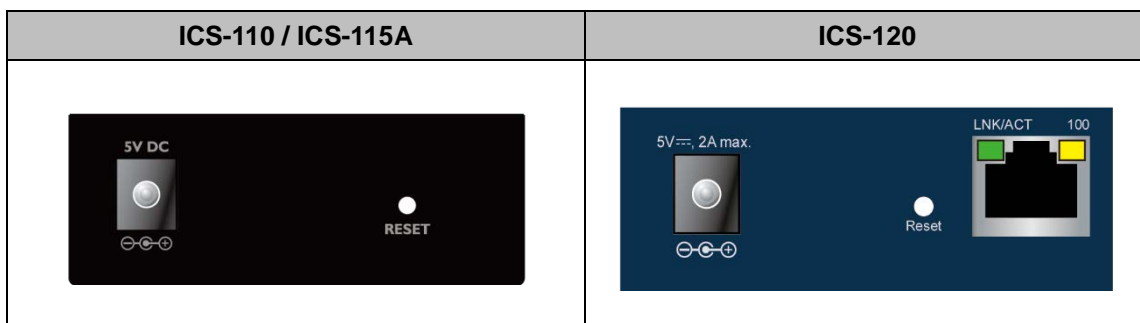

Figure 2-1-3: One DC jack for DC power input

■ **Reset button**

On the rear panel, the **reset button** is designed for rebooting the system. The following is the summary table of the reset button functions:

Reset Button	Reset Button Pressed and Released	Function
System Reset	< 5 sec: System reboot	Reboot the Serial Server
	> 5 sec: Factory default	Reset the Serial Server to Factory Default configuration. The Serial Server will then reboot and load the default settings as shown below: <ul style="list-style-type: none"> ◦ Default Username: admin ◦ Default Password: admin ◦ Default IP address: 192.168.0.100 ◦ Subnet mask: 255.255.255.0 ◦ Default Gateway: 192.168.0.254

2.1.5 Power Information:

The central pole of the Serial Server's power jacks measures 2.5mm wide that require +5VDC power input. It conforms to the bundled AC-DC adapter and PLANET's media chassis. Should you have the issue of power connection, please contact your local sales representative.

Please keep the AC-DC adapter as a spare part when the Serial Server is installed in a media chassis.(ICS-110/115A)



2.5mm
Width of DC Receptacle: **2.5mm**

+5V for each slot



DC receptacle is 2.5mm wide that matches the central pole; the width of the Serial Server DC jack also measures 2.5mm.

Warning: Do not install any improper unit.

The device is a power-required device, meaning it will not work till it is powered. If your networks should be active all the time, please consider using UPS (Uninterrupted Power Supply) for your device. It will prevent you from network data loss or network downtime.

In some areas, installing a surge suppression device may also help to protect your Serial Servers from being damaged by unregulated surge or current to the converter or the power adapter.

2.1.6 Serial Port Pin Define

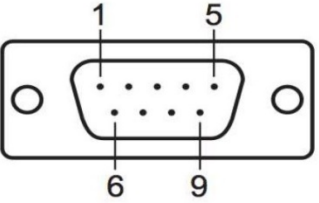
Male DB9	Pin	RS232	RS422 RS485-4W	RS485-2W
	1	DCD	TxD+	--
	2	RxD	TxD-	--
	3	TxD	RxD-	Data-
	4	DTR	RxD+	Data+
	5	GND	GND	GND
	6	DSR	--	--
	7	RTS	--	--
	8	CTS	--	--
	9	--	--	--

2.2 Installing the Serial Server

This section describes how to install your Serial Server and make connections to the Serial Server. Please read the following section and perform the procedure in the order being presented. To install your Serial Server on a desktop or rack, simply complete the following steps.

2.2.1 Installation Steps

1. **Unpack the Serial Server**
2. **Check if the DIN-rail bracket is screwed on the Serial Server or not.** If the DIN-rail bracket is not screwed on the **Serial Server**, please refer to **DIN-rail Mounting** section for DIN-rail installation. If users want to wall-mount the **Serial Server**, please refer to the **Wall Mount Plate Mounting** section for wall-mount plate installation.
3. **To hang the Serial Server on the DIN-rail track or wall.**
4. **Power on the Serial Server.** Connect the **5V DC** power adapter to the Serial Server ,the power LED on the **Serial Server** will light up. Please refer to the **LED Indicators** section for indication of LED lights.
5. **Prepare Network cables for Ethernet connection.**
 - Use standard network (UTP) cables with RJ45
 - Use Multi-mode or Single-mode fiber patch cord with LC connector and 100BASE-FX SFP transceiver (ICS-115A only).
6. **Insert one side of RJ45 cable (category 5) or Fiber cable into the Serial Server Ethernet port** (RJ45/SFP port) while the other side to the network device's Ethernet port (RJ45/SFP port), e.g., Switch PC or Server. The "**LNK/ACT**" LED on the **Serial Server** will light up when the cable is connected with the network device. Please refer to the **LED Indicators** section for LED light indication.

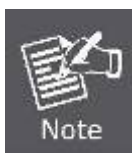

Make sure that the connected network devices support MDI/MDI-X. If it does not support, use the crossover Category 5 cable.

7. **When all connections are set and all LED lights show normal, the installation is completed.**

2.2.2 Wall-mount Installation

Step 1: Please find the wall that can mount the Serial Server

Step 2: Screw two screws on the wall.

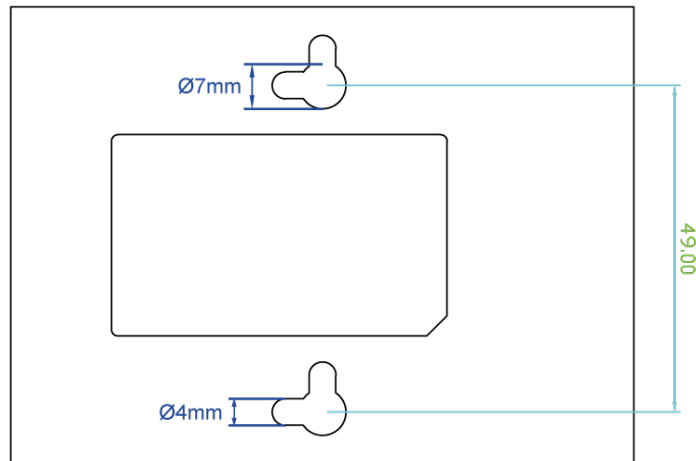

Step 3: Hang the Serial Server on the screws from the wall.

Step 4: Refer to Chapter **2.1.5 Power Information** on power supply to the Serial Server .

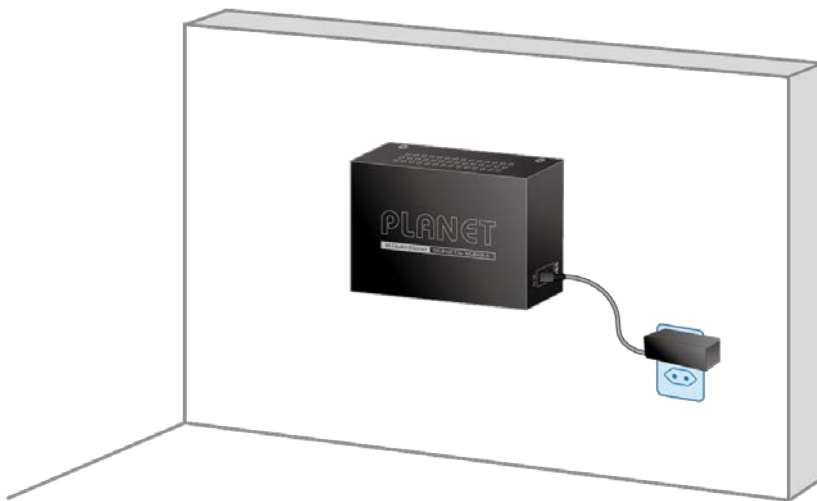

Before mounting the device to the wall, please check the location of the electrical outlet and the length of the Ethernet cable.

2.2.3 Media Chassis Installation (ICS-110/115A)

To install the Serial Server in a **10-inch** or **19-inch** standard rack, follow the instructions described below.

Step 1: Place your Serial Server on a hard flat surface, with the front panel positioned towards your front side.

Step 2: Carefully slide in the module until it is fully and firmly fitted into the slot of the chassis; the Power LED of the Serial Server will turn ON.

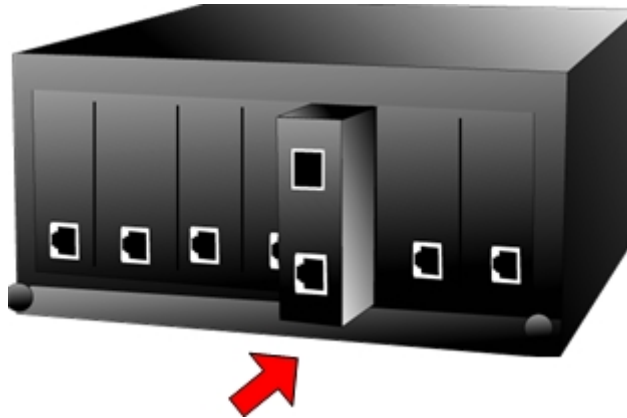

Figure 3-2: Insert Serial Server into an available slot



1. Never push the Serial Server into the slot with force; it could damage the chassis.
2. The Media Converter Chassis supports hot-swap; there is no need to turn off the whole chassis before sliding in the new converter.

Caution

2.2.4 Optional DIN-rail Installation

There are two DIN-rail holes on the left side of the Serial Server that allows to be easily installed by DIN-rail mounting. PLANET optional DIN-rail mounting kit – RKE-DIN -- can be ordered separately. Refer to the following steps for the DIN-rail mounting of the Serial Server:

Step 1: Screw the DIN rail on the Serial Server

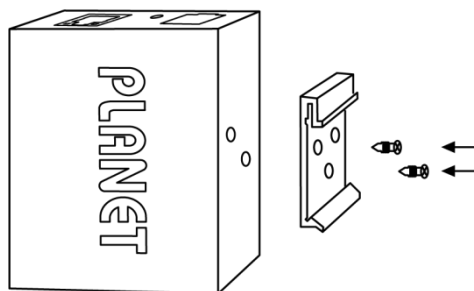

Step 2: Now slide the DIN rail into the track.

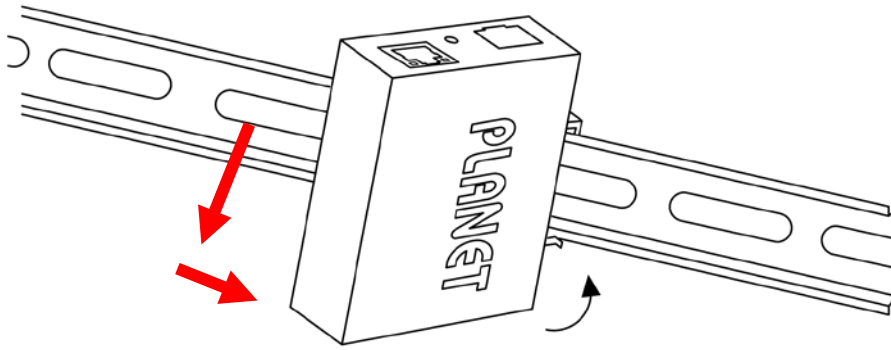

Step 3: Check whether the DIN rail is tightly on the track.

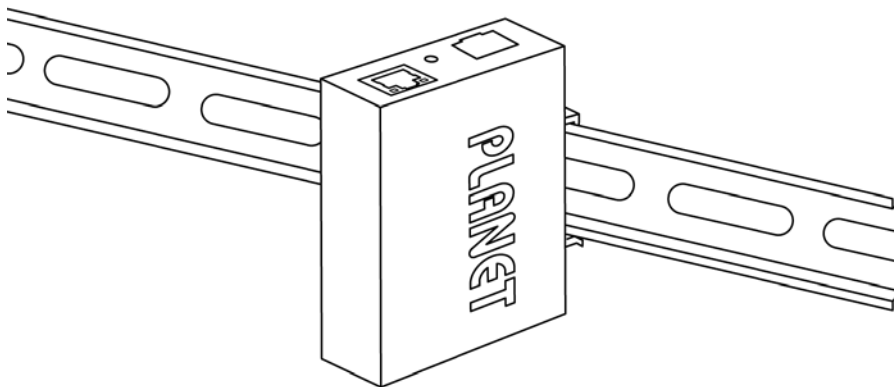

You must use the screws supplied with the mounting brackets. Damage caused to the parts by using incorrect screws would invalidate your warranty.

Caution

3. SERIAL DEVICE SERVER MANAGEMENT

This chapter covers the following topics as to how to manage the Serial Server:

- Requirements
- Web Management
- Remote Management
- PLANET Smart Discovery Utility

3.1 Requirements

- **Workstations** running Windows 2000/XP, 2003, Vista/7/8/10, 2008, MAC OS9 or later, or Linux, UNIX , or other platforms compatible with **TCP/IP** protocols.
- **Workstation** is installed with **Ethernet NIC** (Network Interface Card)
- **Network cables**
 - Use standard network (UTP) cables with RJ45
 - Use Multi-mode or Single-mode fiber patch cord with LC connector and 100BASE-FX SFP transceiver (ICS-115A only).
- The above workstation is installed with **Web Browser** and **JAVA runtime environment** plug-in



It is recommended to use Internet Explorer 7.0 or above to access Serial Server.

3.2 Web Management

The Serial Server offers management features that allow users to manage the Serial Server from anywhere on the network through a standard browser such as Microsoft Internet Explorer. After you set up your IP address for the switch, you can access the Serial Server's Web interface applications directly in your Web browser by entering the IP address of the Serial Server.

For example, the default IP address of the Serial Server is **192.168.0.100**, then the manager PC should be set to **192.168.0.x** (where x is a number between 1 and 254, except 100), and the default subnet mask is 255.255.255.0.

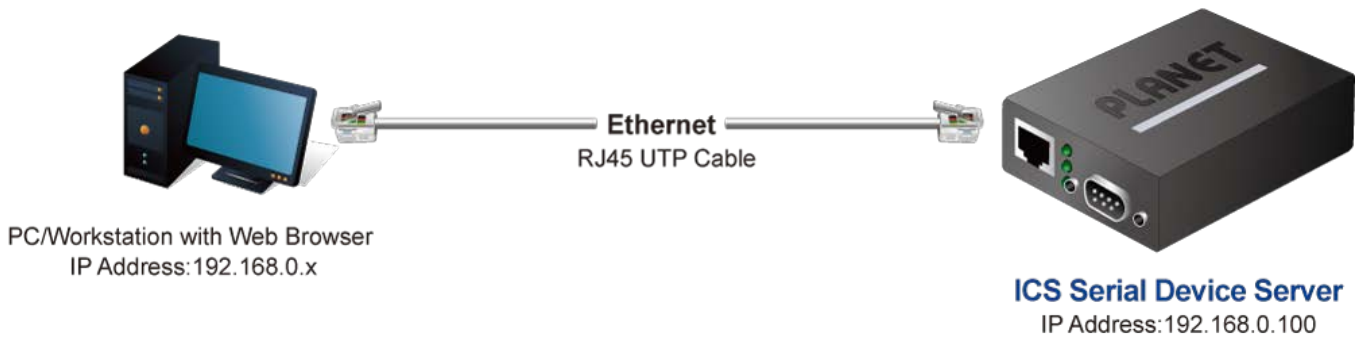

Figure 3-2-1: Web Management

You can then use your Web browser to list and manage the Serial Server configuration parameters from one central location, just as if you were directly connected to the Serial Server's console port. Web Management requires either **Microsoft Internet Explorer 7.0** or later, **Safari** or **Mozilla Firefox 1.5** or later.

3.2.1 Logging in to the Serial Server

1. Use Internet Explorer 8.0 or above for Web browser and enter IP address **<http://192.168.0.100>** (the factory default IP address) to access the Web interface.
2. When the following dialog box appears, please enter the default user name "**admin**" and password "**admin**" (or the password you have changed before) as shown in Figure 4-2.

Default IP Address: **192.168.0.100**
Default User Name: **admin**
Default Password: **admin**

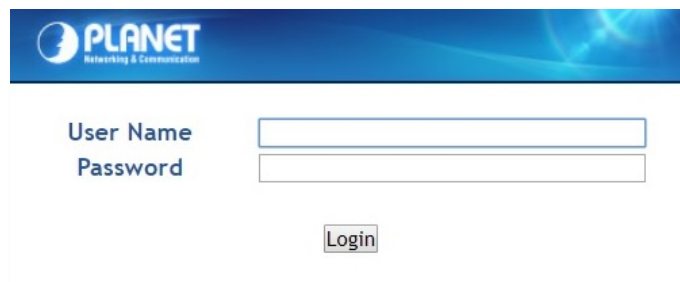

Figure 3-2-2: Login Screen

4. After entering the password, the main screen appears as shown in Figure 3-2-3.

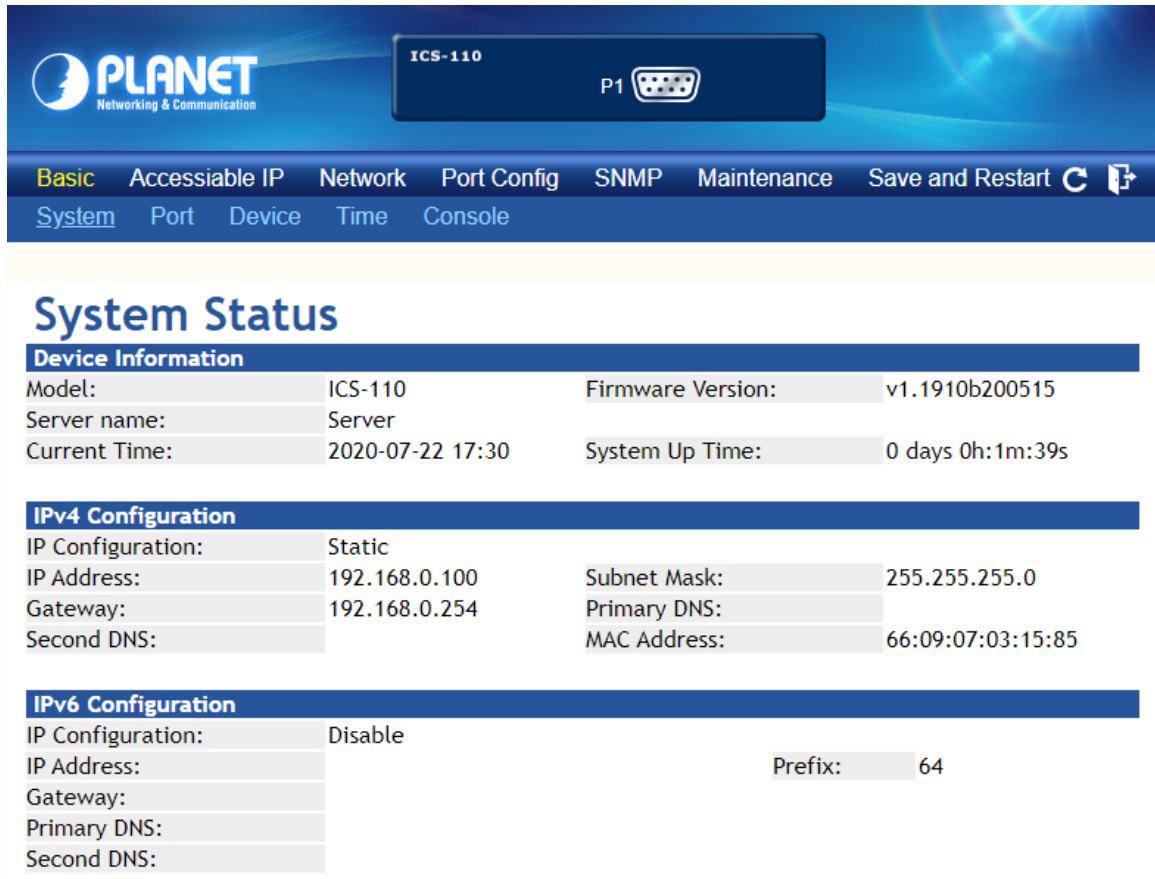

Figure 3-2-3: Web Main Screen of Serial Server

5. The Main Menu in the middle of the Web page lets you access all the functions and statuses. It appears as shown in Figure 3-2-4.

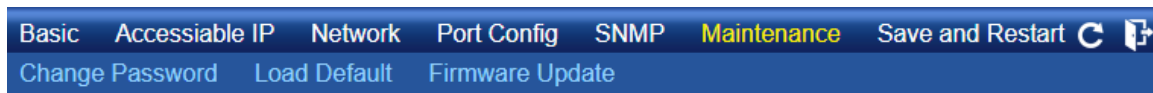

Figure 3-2-4: Main menu

Now, you can use the Web management interface to continue the Serial Server management. Please refer to the user manual for more.



1. For security reason, **please change and memorize the new password after this first setup.**
2. Only accept command in lowercase letter under web interface.

3.3 Remote Management

The Serial Server also supports Telnet for remote management. You can use Telnet to open a terminal session over one of the Ethernet ports. The Serial Server asks for user name and password for remote login when using Telnet; please use the following default IP address, username and password for the first-time login.

Default IP Address: **192.168.0.100**

Default Username: **admin**

Default Password: **admin**

You will be presented with a text menu displaying the Serial Server's general settings, which you will be able to view and modify. It appears as shown in Figure 3-3-1.

```
UserName: admin
Password: *****

-----
* Corporation      : PLANET
* Model           : ICS-110
* MAC Address     : A8:F7:E0:01:96:32
* Firmware Version : v1.1910b200107
* Ethernet IP Address : 192.168.0.100
-----

                Main Menu

[1] Basic
[2] Accessible IP
[3] Network
[4] Serial
[5] SNMP
[6] Change password
[7] Load factory default
[8] Ping
[s] Save and Restart
[q] Quit

Enter your choice:
```

Figure 3-3-1: Remote management

3.4 PLANET Smart Discovery Utility

For easily listing the Serial Server in your Ethernet environment, the Planet Smart Discovery Utility is an ideal solution. The following installation instructions are to guide you to running the Planet Smart Discovery Utility.

1. Download the Planet Smart Discovery Utility from the administrator PC.
2. Run this utility as the following screen appears.

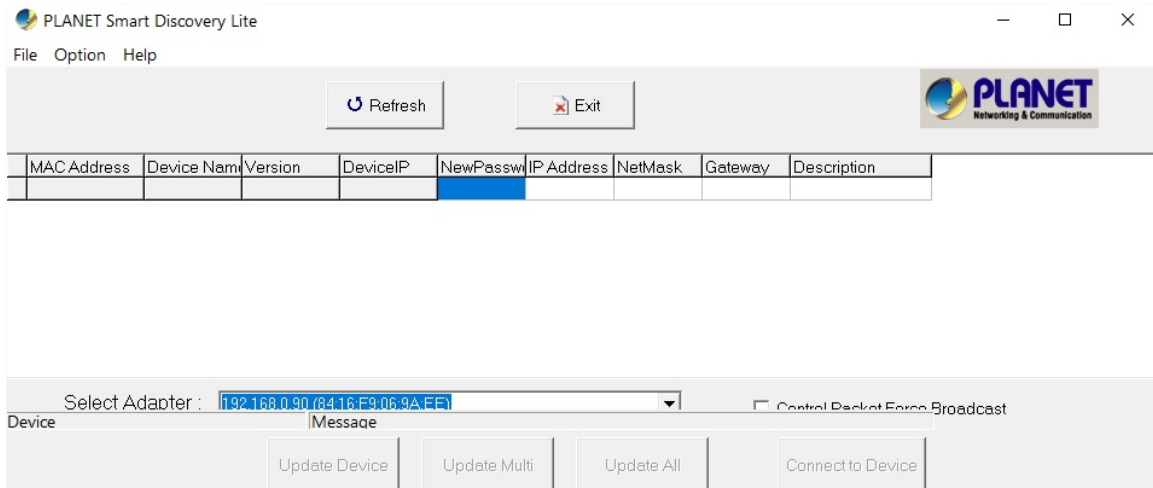

Figure 3-4-1: Planet Smart Discovery Utility Screen



If there are two LAN cards or above in the same administrator PC, choose a different LAN card by using the “**Select Adapter**” tool.

3. Press the “**Refresh**” button for the currently connected devices in the discovery list as shown in [Figure 3-4-2.](#):

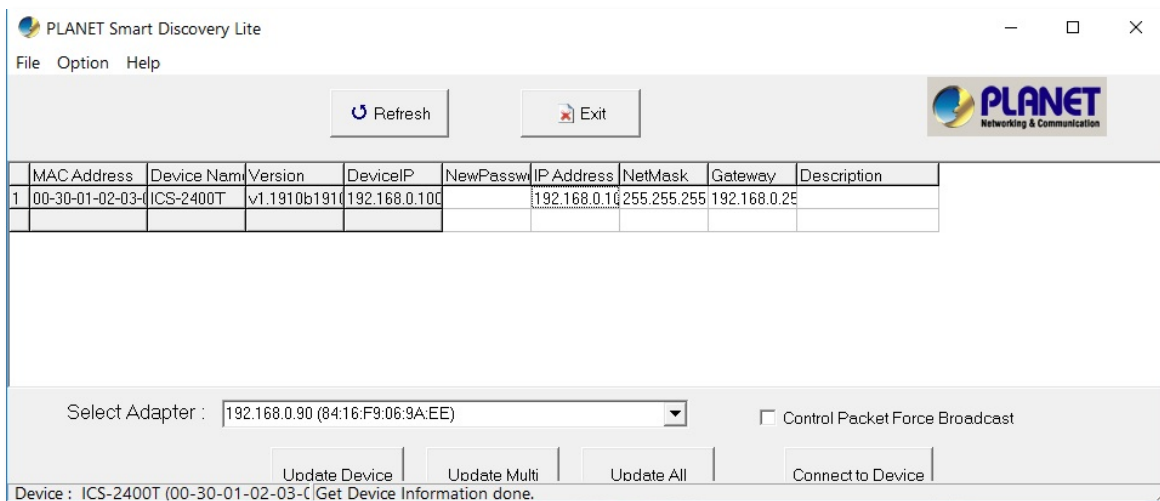

Figure 3-4-2: Planet Smart Discovery Utility Screen

1. This utility shows all the necessary information from the devices, such as MAC address, device name, firmware version, and device IP subnet address. It can also assign new password, IP subnet address and description to the devices.

2. After setup is completed, press the **“Update Device”**, **“Update Multi”** or **“Update All”** button to take effect. The functions of the 3 buttons above are shown below:

- **Update Device:** Use current setting on one single device.
- **Update Multi:** Use current setting on multi-devices.
- **Update All:** Use current setting on whole devices in the list.

The same functions mentioned above also can be found in **“Option”** tools bar.

3. To click the **“Control Packet Force Broadcast”** function, it allows you to assign a new setting value to the Web Smart Switch under a different IP subnet address.

4. Press the **“Connect to Device”** button and the Web login screen appears as shown in [Figure 3-4-2](#).

5. Press the **“Exit”** button to shut down the Planet Smart Discovery Utility.

4. WEB CONFIGURATION

This section introduces the configuration and functions of the Web-based management from Serial Server.

About Web-based Management

The Serial Server offers management features that allow users to manage the Serial Server from anywhere on the network through a standard browser such as Microsoft Internet Explorer.

The Web-based Management supports Internet Explorer 7.0. It is based on Java Applets with an aim to reduce network bandwidth consumption, enhance access speed and present an easy viewing screen.



By default, IE7.0 or later version does not allow Java Applets to open sockets. The user has to explicitly modify the browser setting to enable Java Applets to use network ports.

The Serial Server can be configured through an Ethernet connection, making sure the manager PC must be set to the same IP subnet address with the Serial Server.

For example, the default IP address of the Serial Server is **192.168.0.100**, then the manager PC should be set to **192.168.0.x** (where x is a number between 1 and 254, except 100), and the default subnet mask is 255.255.255.0.

If you have changed the default IP address of the Serial Server to 192.168.1.1 with subnet mask 255.255.255.0 via console, then the manager PC should be set to 192.168.1.x (where x is a number between 2 and 254) to do the relative configuration on manager PC.

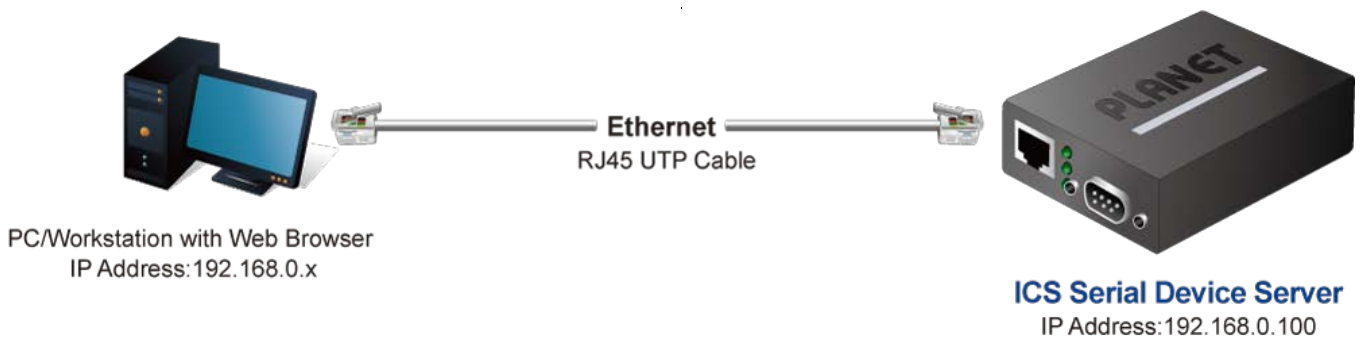

Figure 4-1-1: Web Management

■ **Logging on to the Serial Server**

1. Use Internet Explorer 7.0 or above Web browser. Enter the factory default IP address to access the Web interface. The factory default IP address is shown as follows:

Default IP Address: **192.168.0.100**
 Default Username: **admin**
 Default Password: **admin**

2. When the following login screen appears, please enter the default username "**admin**" with password "**admin**" (or the username/password you have changed via console) to log in the main screen of **Serial Server**. The login screen in [Figure 4-1-2](#) appears.

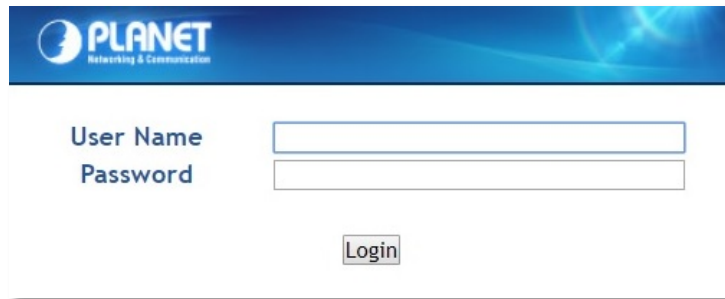

Figure 4-1-2: Login Screen

3. After a successful login, the main screen appears as shown in [Figure 4-1-3](#) below.

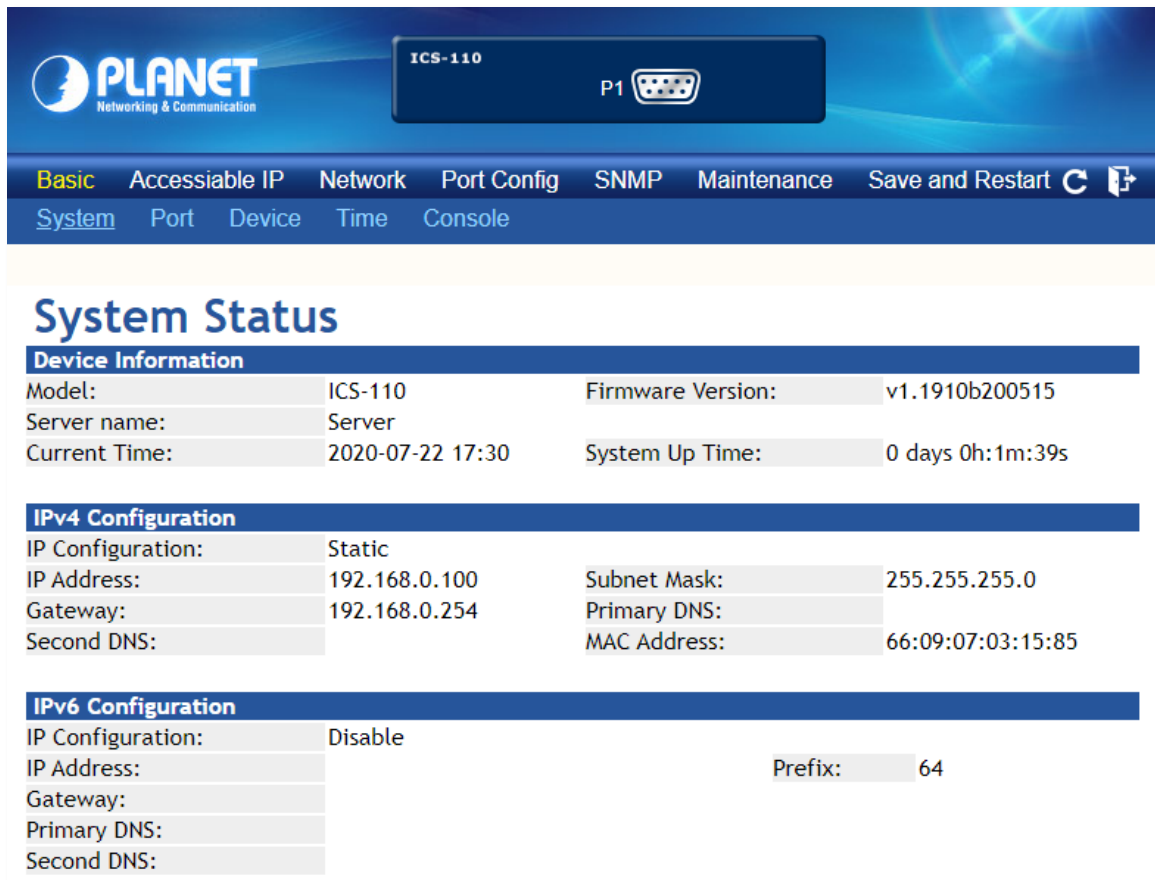

Figure 4-1-3: Web Main Page

Now, you can use the Web management interface to continue the switch management or manage the Serial Server by Web interface.

4.1 Main Web Page

The Serial Server provides a Web-based browser interface for configuring and managing it. This interface allows you to access the Serial Server using the Web browser of your choice. The main web page is shown in [Figure 4-1-4](#)

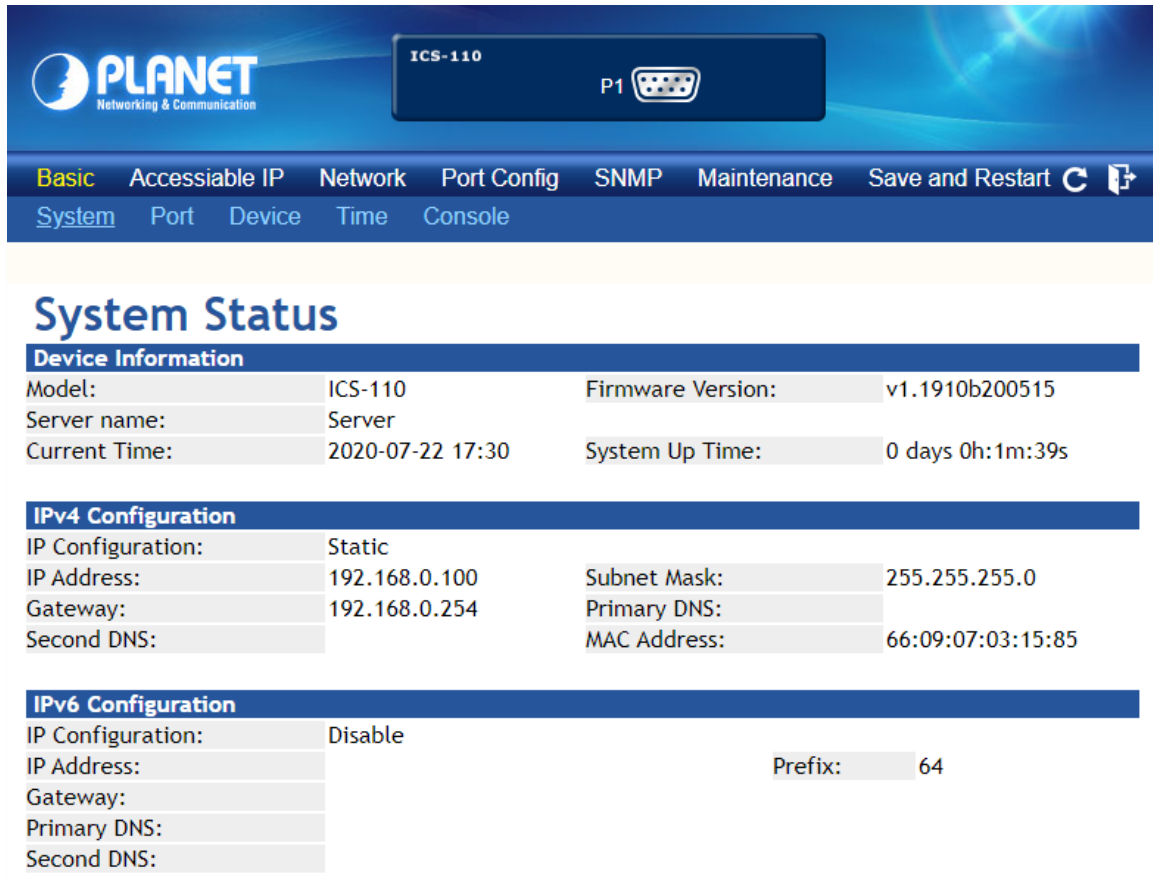

Figure 4-1-4: Web Main Page

Main Menu

Via the Web Management, the administrator can set up the Serial Server by selecting the functions that are listed in the Main Function. The screen in [Figure 4-1-5](#) appears.

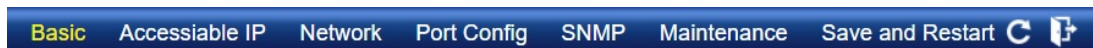



Figure 4-1-5: Serial Server Main Functions Menu

Object	Description
• Basic	The essential device information of Serial Server.
• Accessible IP	To configure IP addresses lists to prevent unauthorized access.
• Network	To configure IP address information of Serial Server.
• Port Config	To configure serial port value and port mode of Serial Server.
• SNMP	To configure SNMP information of Serial Server.
• Maintenance	The management of Serial Server.

• Save and Restart	Save the configuration and reboot device.
• 	Refresh the page
	Log out the Serial Server.

4.2 System

Use the System menu items to display and configure basic administrative details of the Serial Server. Under the System, the following topics are provided to configure and view the system information. This section has the following items:

- **System** The Serial Server system information is provided here.
- **Port** This page displays status of each port.
- **Device** Configure device name and syslog server on this page.
- **Time** Configure NTP server or manually adjust time on this page.
- **Console** Configure management methods on this page.

4.2.1 System

The System page provides basic information for the current device. System page helps an administrator to identify software version, system uptime and IP address information. The screen in [Figure 4-2-1](#) appears.

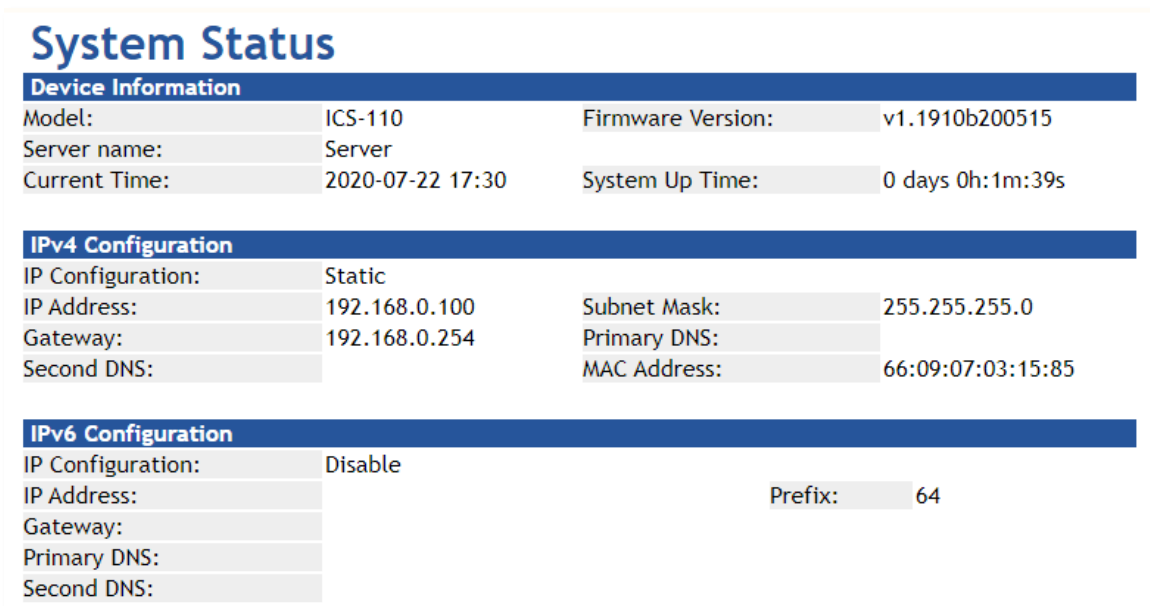

System Status

Device Information			
Model:	ICS-110	Firmware Version:	v1.1910b200515
Server name:	Server		
Current Time:	2020-07-22 17:30	System Up Time:	0 days 0h:1m:39s

IPv4 Configuration			
IP Configuration:	Static		
IP Address:	192.168.0.100	Subnet Mask:	255.255.255.0
Gateway:	192.168.0.254	Primary DNS:	
Second DNS:		MAC Address:	66:09:07:03:15:85

IPv6 Configuration			
IP Configuration:	Disable		
IP Address:		Prefix:	64
Gateway:			
Primary DNS:			
Second DNS:			

Figure 4-2-1: System Status Page Screenshot

The page includes the following fields:

Device Information

Object	Description
• Model	Specifies the device model name.
• Firmware Version	The firmware version of serial server.
• Name	The system name configured in Basic/Device Name.
• Current Time	The current (GMT) system time and date.
• System Up Time	The period of time the device has been operational.

IPv4 Configuration

Object	Description
• IP Configuration	The status of IPv4 configuration.
• IP Address	The current IPv4 address of the device.
• Subnet Mask	The current IPv4 subnet mask of the device.
• Gateway	The current IPv4 gateway of the device.
• Primary DNS	The current first DNS server of the device.
• Second DNS	The current second DNS server of the device.
• MAC Address	Specifies the device MAC address.

IPv6 Configuration

Object	Description
• IP Configuration	The status of IPv6 configuration.
• IP Address	The current IPv6 address of the device.
• Prefix	The IPv6 network mask, in number of bits (prefix length).
• Gateway	The current gateway for the IPv6 interface.
• Primary DNS	The current first DNS server of the device.
• Second DNS	The current second DNS server of the device.

4.2.2 Port

This Port page displays the status of each port, including operation mode and serial settings. The screen in [Figure 4-2-2](#) appears.

Port Status							
No.	Operation Mode	Baud Rate	Stop Bits	Data Bits	Parity	Interface	Flow Control
1	TCP Server	921600	1	8	None	RS-232	None
2	TCP Server	921600	1	8	None	RS-232	None

Figure 4-2-2: Port Status Page Screenshot

The following column shows the Port statuses:

Object	Description
• No.	The serial number (No.) indicates port number. It can be directly linked to the corresponding page settings.
• Operation Mode	The current operation mode of serial server.
• Baud Rate	The rate of data transmission to and from the attached serial device.
• Stop Bits	The stop bit follows the data and parity bits in serial communication. It indicates the end of transmission. The default is 1 .
• Data Bits	Indicates the number of the bits in a transmitted data package. The default is 8 .
• Parity	Checks for the parity type. The default value is none .
• Interface	The device server supports three interfaces. The default value is RS-232 . <ul style="list-style-type: none"> ■ RS-232 ■ RS-422 ■ RS-485 2-Wire ■ RS-485 4-Wire
• Flow Control	The method is used to suspend and resume data transmission to ensure that data is not lost. The default value is none .

4.2.3 Device

This page provides configuration of device name and syslog server. The screen in [Figure 4-2-3](#) appears.

Device Setup

Server Name:	<input type="text" value="Server"/>
Syslog Server:	<input type="text" value="192.168.0.50"/>

Figure 4-2-3: Device Setup Page Screenshot

The page includes the following fields:

Object	Description
• Server Name	To configure the name of server. The default value is Server .
• Syslog Server	To configure IP address of syslog server.



When applying any configuration changes of serial server, it's required to **save changed configuration and reboot system**. Therefore the new configuration will be applied after rebooting.

4.2.4 Time

This page provides configuration of NTP server and Time modification. The screen in [Figure 4-2-4](#) appears.

Time Setup

NTP Time Server:	<input checked="" type="radio"/> time.stdtime.gov.tw <input type="radio"/> 130.149.17.8 - Europe ▼
Time Zone:	UTC+08:00 ▼
Current Time:	2000 Year 01 Month 01 Date 00 Hour 00 Minute 00 second <input type="button" value="Get PC Time"/>

Figure 4-2-4: Time Setup Page Screenshot

The page includes the following fields:

Object	Description
• NTP Time Server	To configure NTP server for time synchronization. The default is time.stdtime.gov.tw .
• Time Zone	Lists various Time Zones worldwide. Select appropriate Time Zone from the drop-down menu and click Save to set.
• Current Time	To manually set the Year / Mouth / Day/ Hour / Minute / Second or get time from PC in this page.

4.2.5 Console

This page is to configure management methods for web and remote console. The screen in [Figure 4-2-5](#) appears.



Figure 4-2-5: Console Setup Page Screenshot

The page includes the following fields:

Object	Description
<ul style="list-style-type: none"> • Web Console 	To enable or disable access to the web console. The default is Enable .
<ul style="list-style-type: none"> • Remote Console 	To enable or disable access to the remote console. The default is Enable .
<ul style="list-style-type: none"> • Current Time 	To check whether the reset button is working or not. The default is No .

4.3 Accessible IP

This page provides the specified IP address to connect with serial server. When the list of accessible IP is enabled, only IP address in the list can connect to device. When the function is disabled, there is no such restriction. List allows user to configure up to four IP groups. The accessible IP setup screen in [Figure 4-3-1](#) appears.

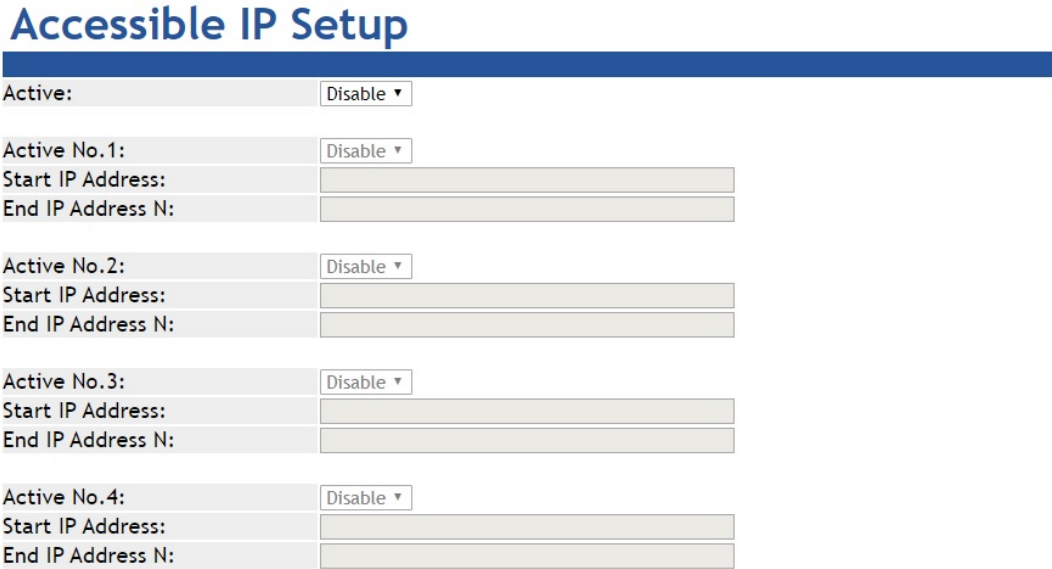

Figure 4-3-1: Accessible IP Setup Page Screenshot

The page includes the following fields:

Object	Description
• Active	Configure the accessible IP list. Possible modes are: Disabled: Disable accessible IP lists. Enabled: Enable accessible IP lists.
• Activate NO	Enable or disable activated IP groups.
• Start IP Address	Enter the IP address for starting.
• End IP Address N	Enter the IP address for ending

Example

Allowed hosts	Start: IP Address setting	End: IP Address N
• Any host	disable	disable
• 192.168.0.120	192.168.0.120	
• 192.168.0.1 to 192.168.0.254	192.168.0.1	192.168.0.254

4.4 Network

This page allows the user to configure IPv4 or IPv6 address. The IP configuration screen in [Figure 4-4-1](#) appears.

IP Configuration

IPv4 Configuration	
IP Configuration:	Static ▾
IP Address:	192.168.0.100
Subnet Mask:	255.255.255.0
Gateway:	192.168.0.254
Primary DNS:	
Second DNS:	

IPv6 Configuration	
IP Configuration:	Disable ▾
IP Address:	[Example] Global 2000::/3, ULA fd00::/7
Prefix:	64
Gateway:	
Primary DNS:	
Second DNS:	

Figure 4-4-1: IP Configuration Page Screenshot

The page includes the following fields:

IPv4

Object	Description
<ul style="list-style-type: none"> • IP Configuration 	Configure static or DHCP to get IPv4 address. The default value is static . <ul style="list-style-type: none"> ■ static: Set a fixed IPv4 address that was manually configured for a device ■ DHCP: Set IPv4 address automatically assigned from a DHCP server.
<ul style="list-style-type: none"> • IP Address 	The current IPv4 Address of the device. The IP Address could be manually assigned. The default value is 192.168.0.100 .
<ul style="list-style-type: none"> • Subnet Mask 	The current IP subnet mask of the device. The default value is 255.255.255.0 .
<ul style="list-style-type: none"> • Gateway 	The default gateway for the IP interface. The default value is 192.168.0.254 .
<ul style="list-style-type: none"> • Primary DNS 	Configure the first DNS server.
<ul style="list-style-type: none"> • Second DNS 	Configure the second DNS server.

IPv6

Object	Description
<ul style="list-style-type: none"> • IP Configuration 	Configure static , SLAAC/DHCP and disable for IPv6 address. The default value is disable . <ul style="list-style-type: none"> ■ Static: Set a fixed IPv6 address that was manually configured for a device ■ SLAAC/DHCP: Set IPv6 address automatically assigned from a DHCPv6 server. ■ Disable: Disable IPv6 protocol.
<ul style="list-style-type: none"> • IP Address 	The current IPv6 Address of the device.

• Prefix	The IPv6 network mask, in number of bits (prefix length). The default value is 64 .
• Gateway	The default gateway for the IPv6 interface.
• Primary DNS	Configure the first DNS server.
• Second DNS	Configure the second DNS server.

4.5 Port Config

The following figure shows port settings. Note that these settings need to match the parameters on serial port of the serial device. Each parameter is described in details in the following section. The port configuration screen in [Figure 4-5-1](#) appears.

Port 1 Setup

Description:	<input type="text"/>	Baud Rate:	921600 ▾
Data Bits:	8 ▾	Any Baud Rate:	50 (50 - 921600)
Stop Bits:	1 ▾	Parity:	None ▾
Interface:	RS-232 ▾	FlowControl:	None ▾

Operation Mode:	TCP Server Mode ▾		
TCP Keep-alive Interval:	0	(min)	
Quiescent Time:	0	(0 - 65535 ms)	
Max Connection:	1 ▾		
Local TCP Port:	5004		
Frame Length:	0	(0 - 1300)	
Separator:	00	(HEX)	Enable: <input type="checkbox"/>
Separator Process:	Do Nothing ▾		
Separator Time Out:	0	(0 - 65535 ms)	

Apply to all serial ports:

Figure 4-5-1: Port Setup Page Screenshot

4.5.1 Serial setup

The serial setup screen is shown in [Figure 4-5-2](#).

Description:	<input type="text"/>	Baud Rate:	921600 ▾
Data Bits:	8 ▾	Any Baud Rate:	50 (50 - 921600)
Stop Bits:	1 ▾	Parity:	None ▾
Interface:	RS-232 ▾	FlowControl:	None ▾

Figure 4-5-2: Serial Setup Page Screenshot

Object	Description
• Description	Used to distinguish the name of each serial port. It allows 1 to 15 characters (e.g. A-Z, a-z, 0-9)
• Baud Rate	The rate of data transmission to and from the attached serial device. It allows 50 bps to 921600 bps. The default is 921600 bps .
• Stop Bits	The stop bit follows the data and parity bits in serial communication. It indicates the end of transmission. The default is 1.
• Data Bits	Indicates the number of the bits in a transmitted data package. The allowed value is 5,6,7,8 and default value is 8.
• Parity	This parameter controls the error checking mode. It support five modes and default value is none . <ul style="list-style-type: none"> ■ Even ■ Odd ■ None ■ Space ■ Mark
• Interface	The device server supports three interfaces. The default value is RS-232 . <ul style="list-style-type: none"> ■ RS-232 ■ RS-422 ■ RS-485 2-Wire ■ RS-485 4-Wire
• Flow Control	The method is used to suspend and resume data transmission to ensure that data is not lost. It supports four methods and default value is none . <ul style="list-style-type: none"> ■ None ■ RTS/CTS ■ Xon/Xoff ■ DTR/DSR

4.5.2 Operation mode

The serial server makes connected Serial equipment become IP-based. That also makes them able to connect to a TCP/IP networking immediately. The serial server allows traditional Computer/Client COM ports access to a serial equipment anywhere on the Ethernet LAN network.

This operation mode can be set up as **Disable**, **Remote Pair Master/Slave**, **RF2217**, **Serial Telnet**, **TCP Server**, **TCP Client**, **UDP**, **Virtual COM** and **Modbus Converter Server/Client**. The operation mode screen in [Figure 4-5-3](#) appears.

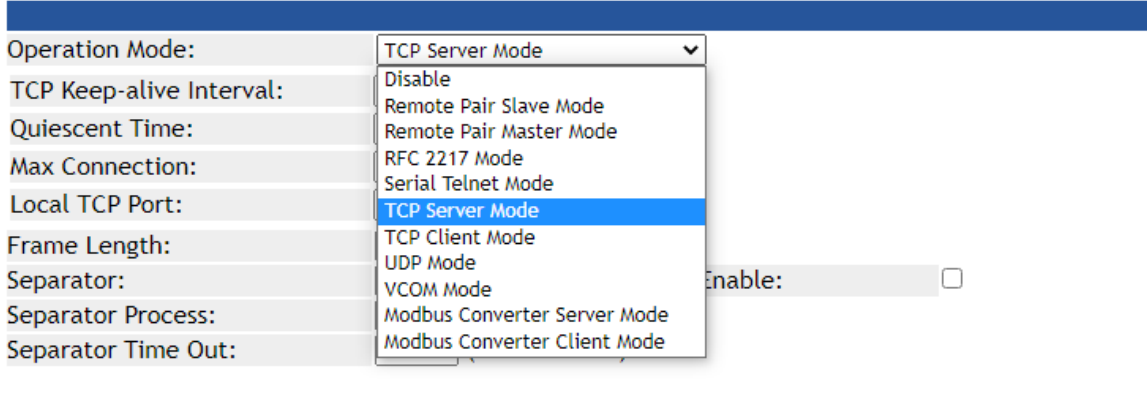

Figure 4-5-3: Operation Mode Screenshot

4.5.2.1 Disable mode

When selecting disabled operation mode, the device port can be disabled. The disable mode screen in [Figure 4-5-4](#) appears.

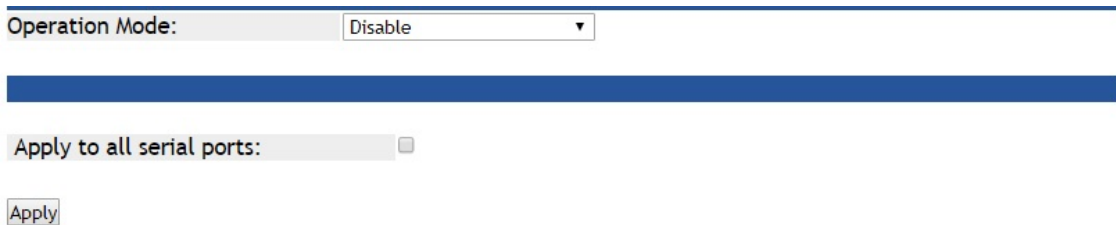

Figure 4-5-4: Disable Mode Screenshot

Object	Description
<ul style="list-style-type: none"> • Apply to all serial ports 	To apply this configuration to all serial ports.

Buttons

Apply: Click to apply port config changes.



When applying any configuration changes of serial server, it's required to **save changed configuration and reboot system**. Therefore the new configuration will be applied after rebooting.

4.5.2.2 Remote Pair Master/Slave mode

When a device connected to an serial server can be transparently connected to another device on serial server; data and modem control signals are exchanged. This protocol can overcome the limitations of traditional serial communication distances and introduce many new usability and feasibility for serial device control. In short, Remote Pair-Master/Slave mode provides tunnel-like functionality over the network. Only one Remote Pair-Slave can be connected to a remote pairing host. The remote pair master/slave topology in [Figure 4-5-5](#) appears.

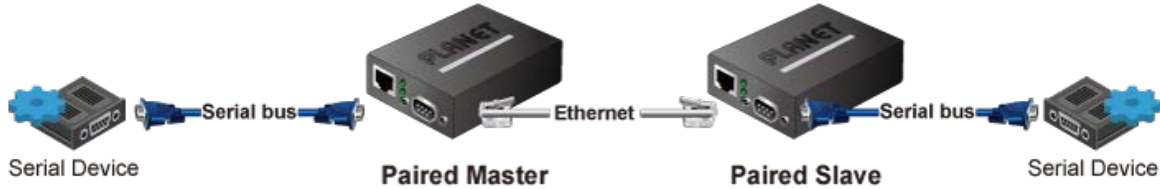

Figure 4-5-5: Remote Pair Master/Slave Topology

The remote pair master mode screenshot in [Figure 4-5-6](#) appears.

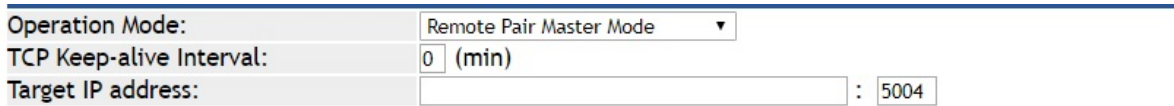

Figure 4-5-6: Remote Pair Master Mode Screenshot

The page includes the following fields:

Object	Description
<ul style="list-style-type: none"> • TCP Keep-alive Interval 	TCP keep alive interval shows how many seconds the unit waits during an inactive connection before checking its status. If the unit does not receive a response, it will drop that connection.
<ul style="list-style-type: none"> • Target IP address 	The Target IP address is the receiver of the message.

The remote pair slave mode screenshot in [Figure 4-5-7](#) appears.

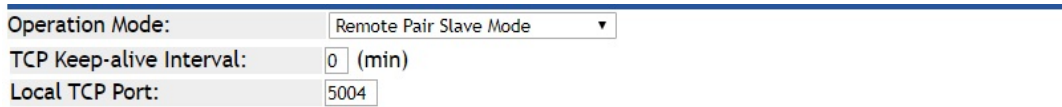

Figure 4-5-7: Remote Pair Slave Mode Screenshot

The page includes the following fields:

Object	Description
<ul style="list-style-type: none"> TCP Keep-alive Interval 	TCP keep alive interval shows how many seconds the unit waits during an inactive connection before checking its status. If the unit does not receive a response, it will drop that connection. The default is 0 minute.
<ul style="list-style-type: none"> Local TCP port 	This parameter describes the TCP port that communicates with the connected device. The setting slave and master destination IP parameters must use the same value to achieve communication. The range of value is from 1 to 65535. The default is 5004 for port 1, 5005 for port 2, 5006 for port 3 and 5007 for port 4

Using Remote Pair Connection mode for two RS-232 services for distance extension, the DB9/RS-232 cables are very important in this application. There are many different kinds of RS-232 cables, such as **straight cable** (standard) and **Null-Modem cable**. Please make sure the DB9/RS-232 cables match the following:

- **Serial Device to ICS-2X00/Remote (Slave)** – Use the original RS-232 serial cable attached in the serial device package.
- **Host / Client to ICS-2X00/Local (Master)** – It has to use the **Null-Modem cable!**

Users can use the Null-Modem cable to directly connect to the ICS-2X00 (Master), or use the Null-Modem DB9 connector, as the picture shows:



Once the Pair Connection mode of the ICS-2X00 is correctly configured but the link is still not connected, check the RS-232 cables!

4.5.2.3 RF2217 mode

RS232 to Ethernet Connector allows to choose the transmission protocol, supporting connections using either the RAW data transmission algorithm or the Telnet (RFC 2217) protocol. Therefore, Telnet can act as an interface to a network device server connected to a remote serial device. The RF2217 mode screenshot in [Figure 4-5-8](#) appears.

Operation Mode:	RFC 2217 Mode	
TCP Keep-alive Interval:	0	(min)
Local TCP Port:	5004	
Frame Length:	0	(0 - 1300)
Separator:	00	(HEX) Enable: <input type="checkbox"/>
Separator Process:	Do Nothing	
Separator Time Out:	0	(0 - 65535 ms)

Figure 4-5-8: RF2217 Mode Screenshot

The page includes the following fields:

Object	Description
• TCP Keep-alive Interval	TCP keep alive interval shows how many seconds the unit waits during an inactive connection before checking its status. If the unit does not receive a response, it will drop that connection. The default is 0 minute.
• Local TCP port	This parameter describes the TCP port that communicates with the connected device. The setting slave and master destination IP parameters must use the same value to achieve communication. The range of value is from 1 to 65535. The default is 5004 for port 1, 5005 for port 2, 5006 for port 3 and , 5007 for port 4
• Frame Length	This parameter can be used to control the data packet. When the device port is in the buffer until the specified data is accumulated, the data will be packed and transmitted by the network. This parameter is 0 to indicate that the data will not be packed until the buffer is full. The range of value is from 0 to 1024. The default is 0 .
• Separator	If the Separator is enabled, the serial receive character port will be discarded until the start separator is detected on the serial port. When the end separator is received, the buffered characters, including the start and end separators, are sent to the network. The range of value is from 0 to FF. The default is disable .
• Separator Process	Separators are ASCII characters specified by the user when configuring the serial serve. This parameter describes how to control characters received on a serial port are sent across the network. The default is Do nothing . <ul style="list-style-type: none"> ■ Do nothing: it will pack the accumulated data including Separators. ■ Strip Separator: it controls striping of Separator from the received characters before the received characters are sent to the network.
• Separator Time Out	Separator timeout controls the maximum amount of time that can be used to buffer characters before the characters are sent to the network. A smaller values will increase the number of network packets, but reduce the amount of time to receive characters, on the contrary, Larger values reduce the number of network packets, but increase the amount of time to receive characters. The range of value is from 0 to 65535. The default is 0 ms .

4.5.2.4 Serial Telnet mode

Telnet (TELEcommunication NETwork) is a network protocol used on the Internet or local area network (LAN) connections. The Telnet protocol type is the correct setting for most servers and serial devices, such as Managed Ethernet switches or Gateways. In the case of a Telnet session, the process is reversed, where the connected server reads and writes data to RS-232 serial port. Once the serial Telnet application is enabled, the serial server will interact with these special CR/LF commands. The serial telnet mode topology in [Figure 4-5-9](#) appears.



Figure 4-5-9: Serial Telnet Mode Topology

The serial Telnet mode screenshot in [Figure 4-5-10](#) appears.

Operation Mode:	Serial Telnet Mode ▾
TCP Keep-alive Interval:	0 (min)
Quiescent Time:	0 (0 - 65535 ms)
Local TCP Port:	5004
Translate CR-LF:	CR-LF ▾

Figure 4-5-10: Serial Telnet Mode Screenshot

Object	Description
<ul style="list-style-type: none"> TCP Keep-alive Interval 	TCP keep alive interval shows how many seconds the unit waits during an inactive connection before checking its status. If the unit does not receive a response, it will drop that connection. The default is 0 minute.
<ul style="list-style-type: none"> Quiescent Time 	When the network connection is determined to be idle, the duration of the control network inactivity will cause the connection to be forced closed. The range of value is from 1 to 65535 ms. The default is 0 ms
<ul style="list-style-type: none"> Local TCP port 	This parameter describes the TCP port that communicates with the connected device. The setting slave and master destination IP parameters must use the same value to achieve communication. The range of value is from 1 to 65535. The default is 5004 for port 1, 5005 for port 2, 5006 for port 3 and , 5007 for port 4
<ul style="list-style-type: none"> Translate CR-LF 	Enter CR-LF characters can be processed after serial server. Just send CR, or LF, or do not modify CR-LF character. The default is CR-LF . <ul style="list-style-type: none"> ■ CR-LF ■ CR ■ LF

Example: Use PuTTY TCP/IP Winsock mode

PuTTY is a free implementation of Telnet and SSH for Win32 and Unix platforms, along with an xterm terminal emulator. In this case we use PuTTY to connect GS-5220-24P4XV managed switch via ICS-110.

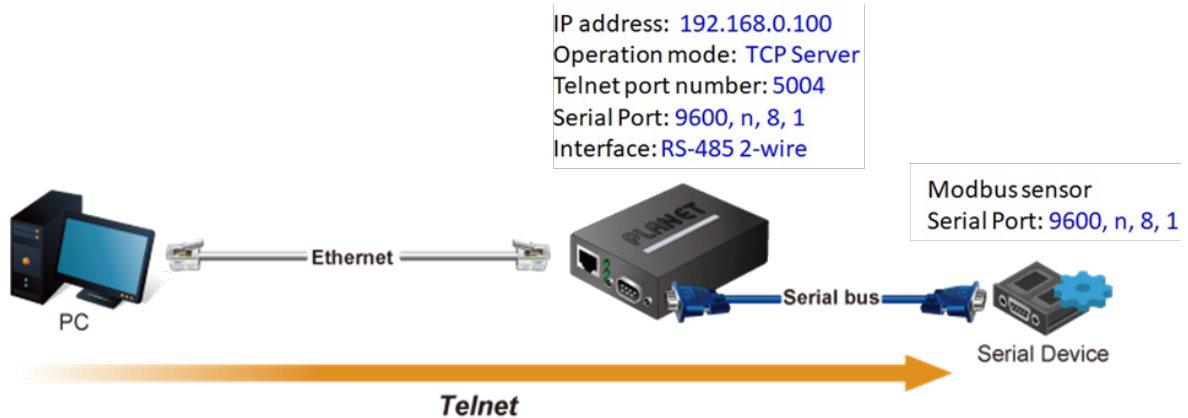

Figure 4-5-11: Serial Telnet Mode Application

ICS-110

1. Set Port Configuration as shown below.

Description:		Baud Rate:	115200
Data Bits:	8	Any Baud Rate:	50 (50 - 921600)
Stop Bits:	1	Parity:	None
Interface:	RS-232	FlowControl:	None

Figure 4-5-12: Port Configuration

2. Set operation mode as **Serial Telnet mode**.
3. Run the Telnet software like "PuTTY" and set parameters as shown below:
- 4.

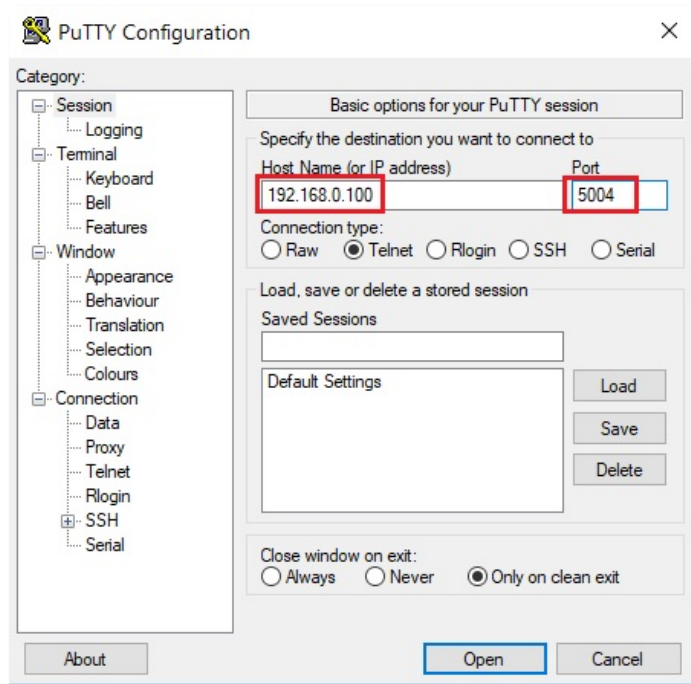

Figure 4-5-13: Putty Configuration

5. Then it can connect to switch successfully.

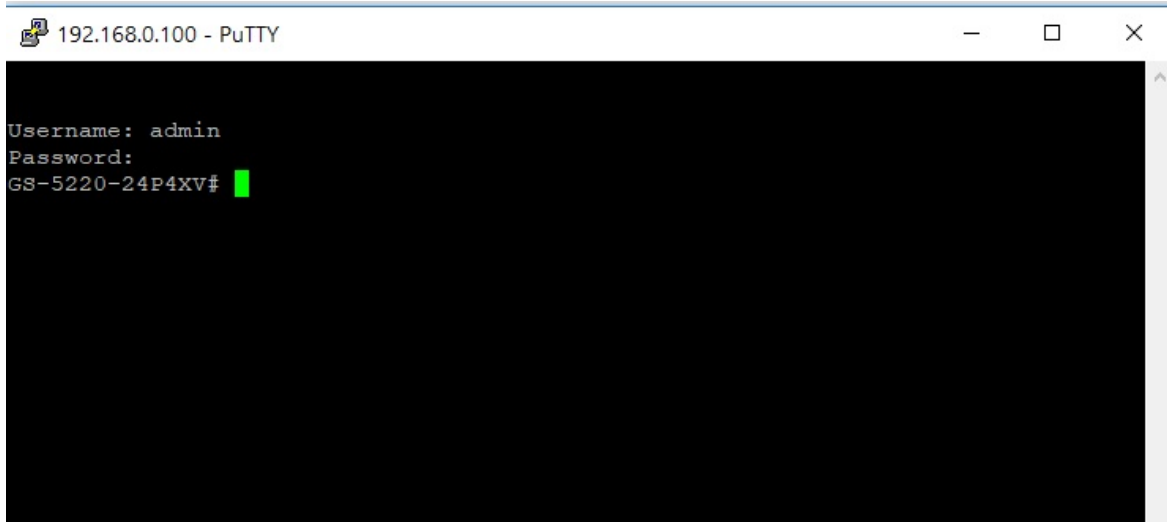

Figure 4-5-14: Putty Connection

4.5.2.5 TCP Server mode

When the serial server is configured as a TCP server, it waits for a connection initiated by another network device. User must set the local TCP port number for which it will listen for the connection, and the serial server provides the maximum number of two concurrent connections. Incidentally, serial server can be configured as a client or server. The TCP server mode topology in [Figure 4-5-115](#) appears.

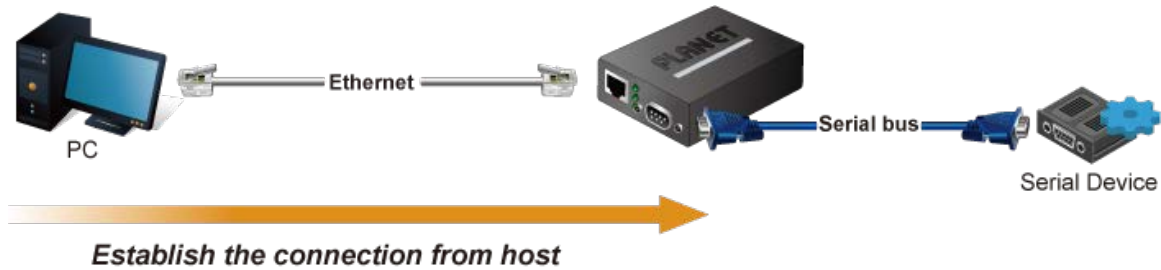

Figure 4-5-15: TCP Server Mode Topology

The TCP server mode screenshot in [Figure 4-5-16](#) appears.

Operation Mode:	TCP Server Mode	
TCP Keep-alive Interval:	0	(min)
Quiescent Time:	0	(0 - 65535 ms)
Max Connection:	1	
Local TCP Port:	5004	
Frame Length:	0	(0 - 1300)
Separator:	00	(HEX) Enable: <input type="checkbox"/>
Separator Process:	Do Nothing	
Separator Time Out:	0	(0 - 65535 ms)

Figure 4-5-16: TCP Server Mode Screenshot

Object	Description
<ul style="list-style-type: none"> TCP Keep-alive Interval 	TCP keep alive interval shows how many seconds the unit waits during an inactive connection before checking its status. If the unit does not receive a response, it will drop that connection. The default is 0 minute.
<ul style="list-style-type: none"> Quiescent Time 	When the network connection is determined to be idle, the duration of the control network inactivity will cause the connection to be forcibly closed. The range of value is from 1 to 65535 ms. The default is 0 ms
<ul style="list-style-type: none"> Max connection 	This parameter set the TCP port number on which it will listen for the connection and set the maximum (up to two) acceptable number of connections. The range of value is from 1 to 4. The default is 1 .
<ul style="list-style-type: none"> Local TCP port 	This parameter describes the TCP port that communicates with the connected device. The setting slave and master destination IP parameters must use the same value to achieve communication. The range of value is from 1 to 65535. The default is 5004 for port 1, 5005 for port 2, 5006 for port 3 and , 5007 for port 4
<ul style="list-style-type: none"> Frame Length 	This parameter can be used to control the data packet. When the device port is in the buffer until the specified data is accumulated, the data will be packed and transmitted by the network. This parameter is 0 to indicate that the data will not be packed until the buffer is full. The range of value is from 0 to 1024. The default is 0 .

<ul style="list-style-type: none"> • Separator 	<p>If the Separator is enabled, the serial receive character port will be discarded until the start separator is detected on the serial port. When the end separator is received, the buffered characters, including the start and end separators, are sent to the network.</p> <p>The range of value is from 0 to FF. The default is disable.</p>
<ul style="list-style-type: none"> • Separator Process 	<p>Separators are ASCII characters specified by the user when configuring the serial serve. This parameter describes how to control characters received on a serial port are sent across the network. The default is Do nothing.</p> <ul style="list-style-type: none"> ■ Do nothing: it will pack the accumulated data including Separators. ■ Strip Separator: it controls striping of Separator from the received characters before the received characters are sent to the network.
<ul style="list-style-type: none"> • Separator Time Out 	<p>Separator timeout controls the maximum amount of time that can be used to buffer characters before the characters are sent to the network. A smaller values will increase the number of network packets, but reduce the amount of time to receive characters, on the contrary, Larger values reduce the number of network packets, but increase the amount of time to receive characters. The range of value is from 0 to 65535. The default is 0 ms.</p>

Example: Connect to Modbus sensor via TCP server mode

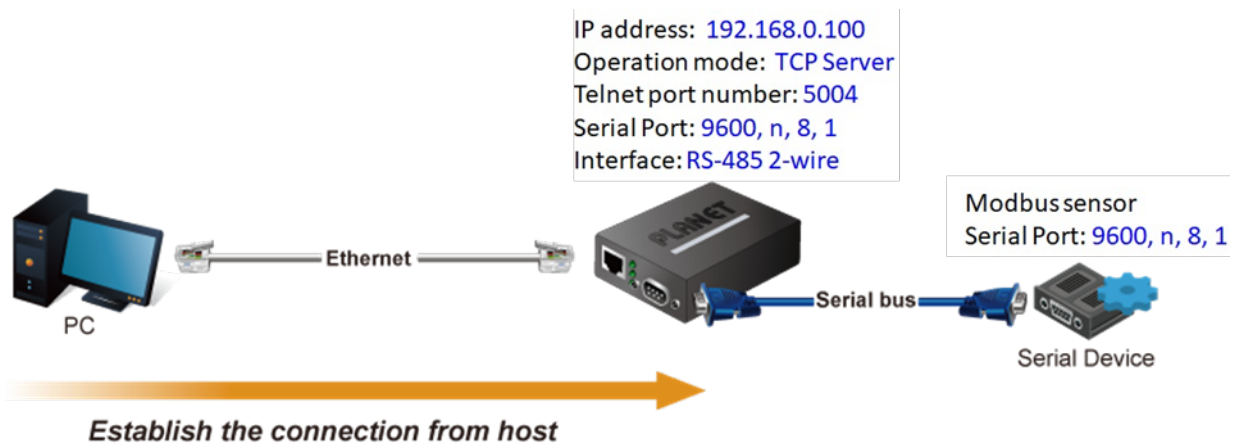

Figure 4-5-17: TCP Server Mode Application

ICS-110

1. Set Port Configuration as shown below.

Description:	<input type="text"/>	Baud Rate:	9600 ▾
Data Bits:	8 ▾	Any Baud Rate:	50 (50 - 921600)
Stop Bits:	1 ▾	Parity:	None ▾
Interface:	RS-485 2-Wire ▾	FlowControl:	None ▾

Figure 4-5-18: Port Configuration

2. Set operation mode as **Telnet Server mode**.

Operation Mode:	TCP Server Mode	
TCP Keep-alive Interval:	0	(min)
Quiescent Time:	0	(0 - 65535 ms)
Max Connection:	1	
Local TCP Port:	5004	
Frame Length:	0	(0 - 1300)
Separator:	00	(HEX) Enable: <input type="checkbox"/>
Separator Process:	Do Nothing	
Separator Time Out:	0	(0 - 65535 ms)

Figure 4-5-19: TCP Server Mode Configuration

- Run the modbus master application (e.g. Modbus Poll) and set parameters as shown below.

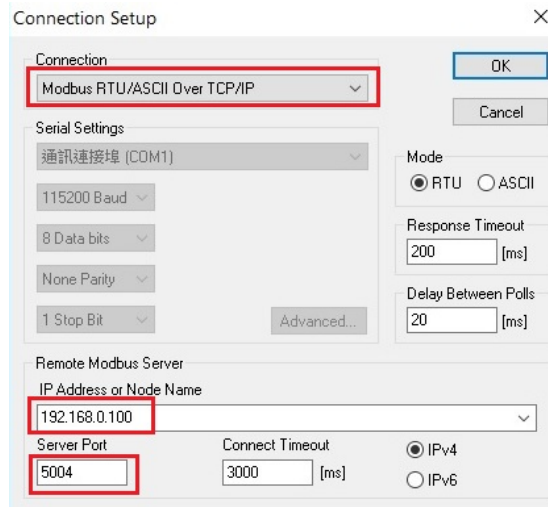

Figure 4-5-20: Modbus application Configuration

- Modbus master application (e.g. Modbus Poll) reads data from modbus sensor successfully.

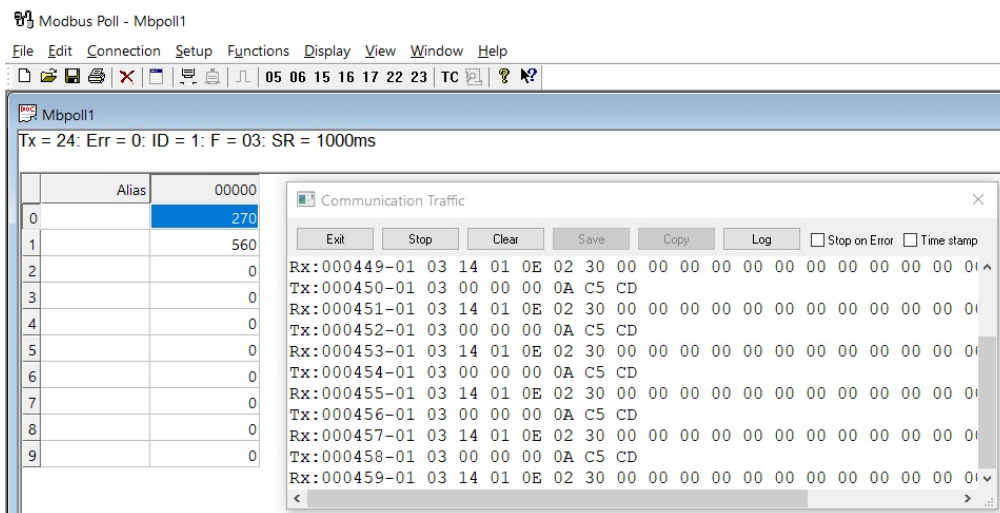

Figure 4-5-21: Modbus Connection

4.5.2.6 TCP Client mode

The TCP client initiates a connection to the server on the network. You must set up the target IP address and assigned local port number of server that you want the client to communicate with. In the data transmission phase, the data is transmitted to the destination in the order to which they are sent. SERIAL SERVER device supports four sets of sequential connections. The TCP client mode topology in [Figure 4-5-22](#) appears.



Figure 4-5-22: TCP Client Mode Topology

The TCP client mode screenshot in [Figure 4-5-23](#) appears.

Operation Mode:	TCP Client Mode		
TCP Keep-alive Interval:	0	(min)	
Quiescent Time:	0	(0 - 65535 ms)	
Frame Length:	0	(0 - 1300)	
Separator:	00	(HEX)	Enable <input type="checkbox"/>
Separator Process:	Do Nothing		
Separator Time Out:	0	(0 - 65535 ms)	
Connection Target IP Address			
Target IP 1:		:	5004
Target IP 2:		:	5004
Target IP 3:		:	5004
Target IP 4:		:	5004
Assigned Local Port (0 - 65535)			
Port 1:	5004	Port 2:	5004
Port 3:	5004	Port 4:	5004
Connection Control:	Startup/None (Connect on/Disconnect by)		

Figure 4-5-23: TCP Client Mode Screenshot

Object	Description
• TCP Keep-alive Interval	TCP keep alive interval shows how many seconds the unit waits during an inactive connection before checking its status. If the unit does not receive a response, it will drop that connection. The default is 0 minute.
• Quiescent Time	When the network connection is determined to be idle, the duration of the control network inactivity will cause the connection to be forced closed. The range of value is from 1 to 65535 ms. The default is 0 ms
• Max connection	This parameter set the TCP port number on which it will listen for the connection and set the maximum (up to two) acceptable number of connections. The range of value is from 1 to 4. The default is 1 .
• Local TCP port	This parameter describes the TCP port that communicates with the connected device. The setting slave and master destination IP parameters must use the same value to achieve communication. The range of value is from 1 to 65535. The default is 5004 for

	port 1, 5005 for port 2, 5006 for port 3 and , 5007 for port 4.
• Frame Length	This parameter can be used to control the data packet. When the device port is in the buffer until the specified data is accumulated, the data will be packed and transmitted by the network. This parameter is 0 to indicate that the data will not be packed until the buffer is full. The range of value is from 0 to 1024. The default is 0 .
• Separator	If the Separator is enabled, the serial receive character port will be discarded until the start separator is detected on the serial port. When the end separator is received, the buffered characters, including the start and end separators, are sent to the network. The range of value is from 0 to FF. The default is disable .
• Separator Process	Separators are ASCII characters specified by the user when configuring the serial serve. This parameter describes how to control characters received on a serial port are sent across the network. The default is Do nothing . <ul style="list-style-type: none"> ■ Do nothing: it will pack the accumulated data including Separators. ■ Strip Separator: it controls striping of Separator from the received characters before the received characters are sent to the network.
• Separator Time Out	Separator timeout controls the maximum amount of time that can be used to buffer characters before the characters are sent to the network. A smaller values will increase the number of network packets, but reduce the amount of time to receive characters, on the contrary, Larger values reduce the number of network packets, but increase the amount of time to receive characters. The range of value is from 0 to 65535. The default is 0 ms .

Connection Target IP address

Object	Description
• Target IP address 1 through 4	IP addresses are used to deliver packets of data across a network and have what is termed end-to-end significance. The network data is sent to the device in a first-in, first-out (FIFO) method. During data transfer phase, data is transmitted sequentially through established path-arriving at the destination in the order in which it was sent.

Assign Local Port

Object	Description
• Local listen port	The range of value is from 1 to 65535. The default is 5004 for port 1, 5005 for port 2, 5006 for port 3 and , 5007 for port 4.
• Connection control	The default is Startup/None . <ul style="list-style-type: none"> ■ Startup/None ■ Any Character/None ■ Any Character/Quiescent time ■ DCD On/DCD Off ■ DCD On/None ■ DSR On/DSR Off ■ DSR On/None

4.5.2.7 UDP mode

UDP is a Connectionless of the non-reliable transmission protocol; it does not need to verify information and does not guarantee correctness for some of the larger amount of information. The reliability is greater than the reliability of transmission which is a good choice. UDP mode can allocate up to four ranges of IP. Each network output data is copied and sent to each IP for each range. The UDP mode topology in [Figure 4-5-24](#) appears.

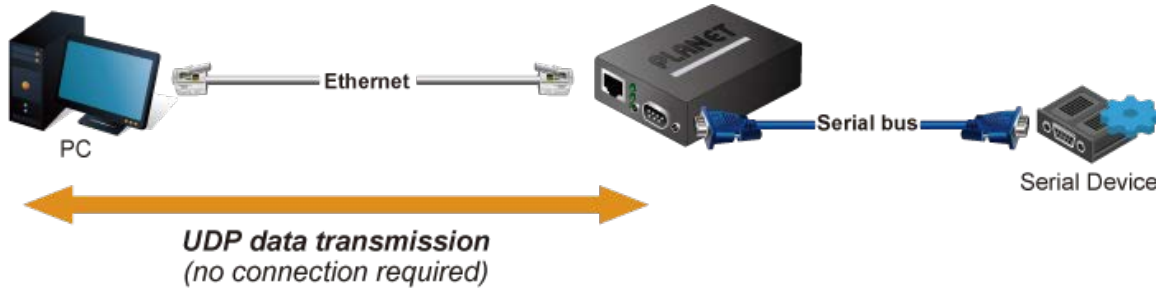

Figure 4-5-24: UDP Mode Topology

The UDP mode screenshot in [Figure 4-5-25](#) appears.

Operation Mode:	UDP Mode		
Local Listen Port:	5004		
Frame Length:	0	(0 - 1300)	
Separator:	00	(HEX)	Enable: <input type="checkbox"/>
Separator Process:	Do Nothing		
Separator Time Out:	0	(0 - 65535 ms)	

Connection Target IP Address			
Target IP 1:		:	5004 (0=Learning)
Target IP 2:		:	5004 (0=Learning)
Target IP 3:		:	5004 (0=Learning)
Target IP 4:		:	5004 (0=Learning)

Figure 4-5-25: UDP Mode Screenshot

Object	Description
• TCP Keep-alive Interval	TCP keep alive interval shows how many seconds the unit waits during an inactive connection before checking its status. If the unit does not receive a response, it will drop that connection. The default is 0 minute.
• Local listen port	The range of value is from 1 to 65535. The default is 5004 for port 1, 5005 for port 2, 5006 for port 3 and , 5007 for port 4.
• Frame Length	This parameter can be used to control the data packet. When the device port is in the buffer until the specified data is accumulated, the data will be packed and transmitted by the network. This parameter is 0 to indicate that the data will not be packed until the buffer is full. The range of value is from 0 to 1024. The default is 0 .
• Separator	If the Separator is enabled, the serial receive character port will be discarded until the start separator is detected on the serial port. When the end separator is received, the buffered characters, including the start and end separators, are sent to the network. The range of value is from 0 to FF. The default is disable .

<ul style="list-style-type: none"> • Separator Process 	<p>Separators are ASCII characters specified by the user when configuring the serial serve. This parameter describes how to control characters received on a serial port are sent across the network. The default is Do nothing.</p> <ul style="list-style-type: none"> ■ Do nothing: it will pack the accumulated data including Separators. ■ Strip Separator: it controls striping of Separator from the received characters before the received characters are sent to the network.
<ul style="list-style-type: none"> • Separator Time Out 	<p>Separator timeout controls the maximum amount of time that can be used to buffer characters before the characters are sent to the network. A smaller values will increase the number of network packets, but reduce the amount of time to receive characters, on the contrary, Larger values reduce the number of network packets, but increase the amount of time to receive characters. The range of value is from 0 to 65535 ms. The default is 0 ms.</p>

Connection Target IP address

Object	Description
<ul style="list-style-type: none"> • Target IP address 1 through 4 	<p>IP addresses are used to deliver packets of data across a network and have what is termed end-to-end significance. The network data is sent to the device in a first-in, first-out (FIFO) method. During data transfer phase, data is transmitted sequentially through established path-arriving at the destination in the order in which it was sent.</p>

4.5.2.8 Virtual COM mode

VCOM mode functionality provides a virtual-local COM port for Windows systems. The VCOM driver should be installed on the PC through the VCOM Administration Utility. The driver establishes a TCP connection to the connected serial device by mapping the local serial port to the IP port of the device port. VCOM mode also supports up to 256 mirroring ports at the same time, but must be in accordance with the computer resources. The Virtual COM mode topology in [Figure 4-5-26](#) appears.



Figure 4-5-26: Virtual COM Mode Topology

The Virtual COM mode screenshot in [Figure 4-5-27](#) appears.

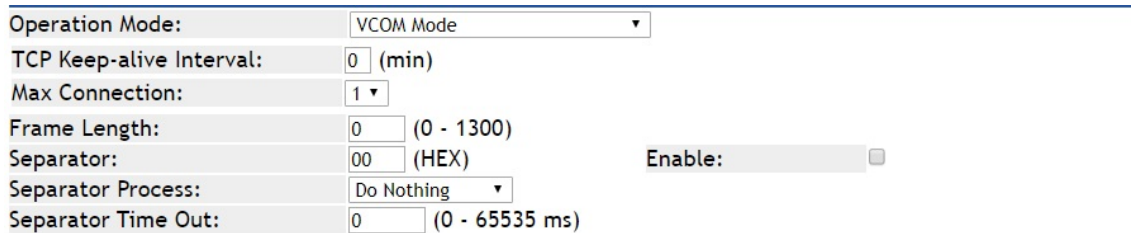

Figure 4-5-27: Virtual COM Mode Screenshot

Object	Description
<ul style="list-style-type: none"> • TCP Keep-alive Interval 	TCP keep alive interval shows how many seconds the unit waits during an inactive connection before checking its status. If the unit does not receive a response, it will drop that connection. The default is 0 minute.
<ul style="list-style-type: none"> • Max connection 	This parameter set the TCP port number on which it will listen for the connection and set the maximum (up to two) acceptable number of connections. The range of value is from 1 to 4. The default is 1.
<ul style="list-style-type: none"> • Frame Length 	This parameter can be used to control the data packet. When the device port is in the buffer until the specified data is accumulated, the data will be packed and transmitted by the network. This parameter is 0 to indicate that the data will not be packed until the buffer is full. The range of value is from 0 to 1024. The default is 0.
<ul style="list-style-type: none"> • Separator 	If the Separator is enabled, the serial receive character port will be discarded until the start separator is detected on the serial port. When the end separator is received, the buffered characters, including the start and end separators, are sent to the network. The range of value is from 0 to FF. The default is disable .
<ul style="list-style-type: none"> • Separator Process 	Separators are ASCII characters specified by the user when configuring the serial serve. This parameter describes how to control characters received on a serial port are sent across the network. The default is Do nothing .

	<ul style="list-style-type: none"> ■ Do nothing: it will pack the accumulated data including Separators. ■ Strip Separator: it controls striping of Separator from the received characters before the received characters are sent to the network.
<ul style="list-style-type: none"> • Separator Time Out 	<p>Separator timeout controls the maximum amount of time that can be used to buffer characters before the characters are sent to the network. A smaller values will increase the number of network packets, but reduce the amount of time to receive characters, on the contrary, Larger values reduce the number of network packets, but increase the amount of time to receive characters. The range of value is from 0 to 65535. The default is 0 ms.</p>

Example: Connect to Modbus sensor via Virtual COM mode



Figure 4-5-28: Virtual COM Mode Application

ICS-110

1. Set Port Configuration as shown below.

Description:	<input type="text"/>	Baud Rate:	9600
Data Bits:	8	Any Baud Rate:	50 (50 - 921600)
Stop Bits:	1	Parity:	None
Interface:	RS-485 2-Wire	FlowControl:	None

Figure 4-5-29: Port Configuration

2. Set operation mode as **VCOM mode**.

Operation Mode:	VCOM Mode	Enable:	<input type="checkbox"/>
TCP Keep-alive Interval:	0 (min)		
Max Connection:	1		
Frame Length:	0 (0 - 1300)		
Separator:	00 (HEX)		
Separator Process:	Do Nothing		
Separator Time Out:	0 (0 - 65535 ms)		

Figure 4-5-30: VCOM Mode Configuration

- Run VCOM software to set port mapping. Port 1 is related to COM4 port.

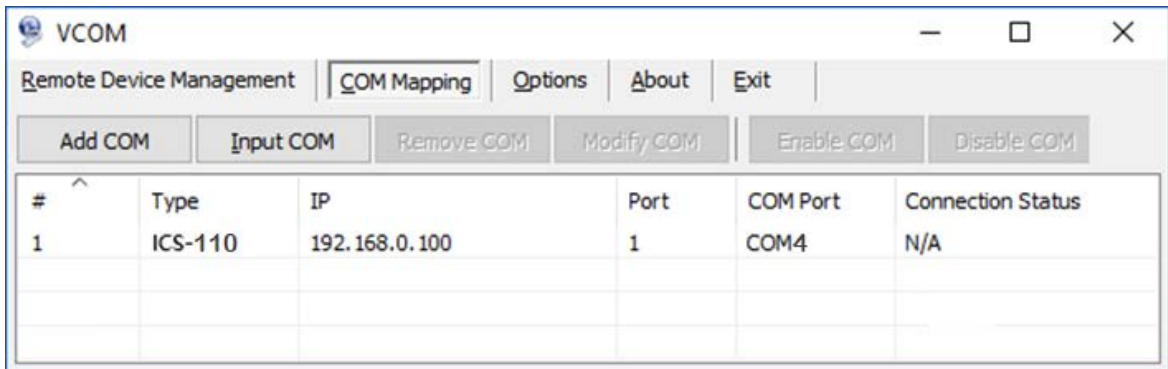

Figure 4-5-31: VCOM Software

- Run the modbus master application (e.g. Modbus Poll) and set parameters as shown below.

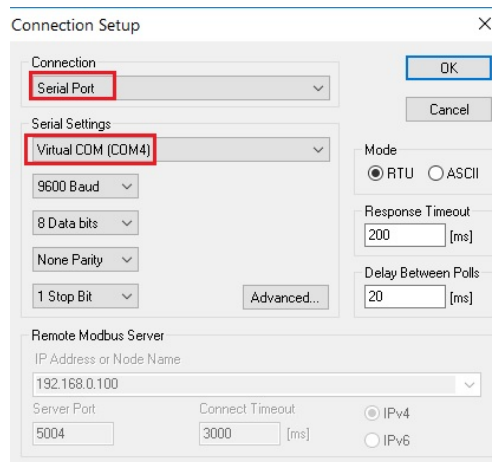

Figure 4-5-32: Modbus application Configuration

- Modbus master application (e.g. Modbus Poll) reads data from modbus sensor successfully.

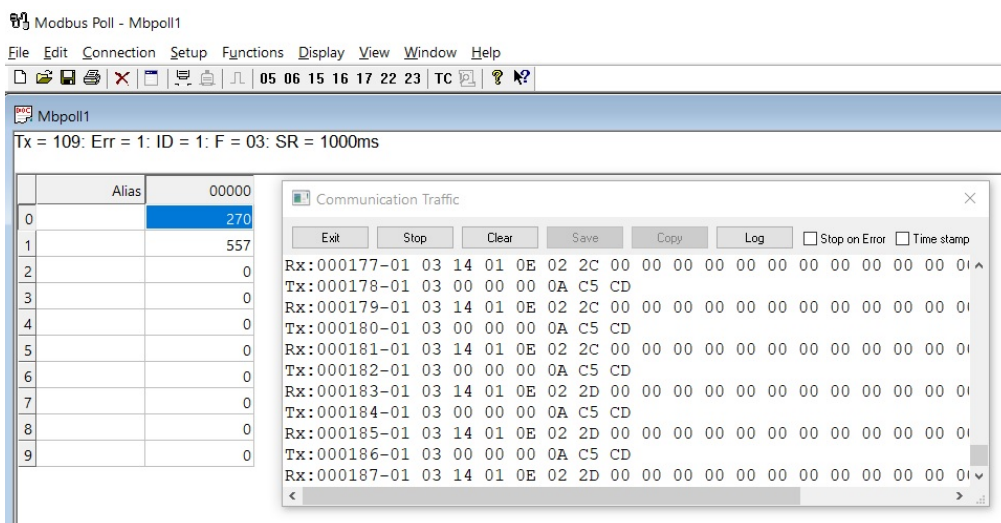

Figure 4-5-33: Modbus Poll Connection

4.5.2.9 Modbus Converter Server mode

The ICS Serial devices support standard Modbus protocol and various hardware interfaces (serial and Ethernet). Modbus TCP and RTU can be used to convert the Modbus protocol. The Modbus master can communicate with the serial network of devices connected to the serial port of the server converter via a server converter.

The meter receives Modbus TCP / IP data on TCP port 502, translates it to a Modbus RTU, and then forwards it to the addressed slave device.

Functionally allows monitoring software to access information from slaves for trend analysis, data collection, alarm/event management, maintenance and other functions. The Modbus Converter Server mode topology in [Figure 4-5-34](#) appears.

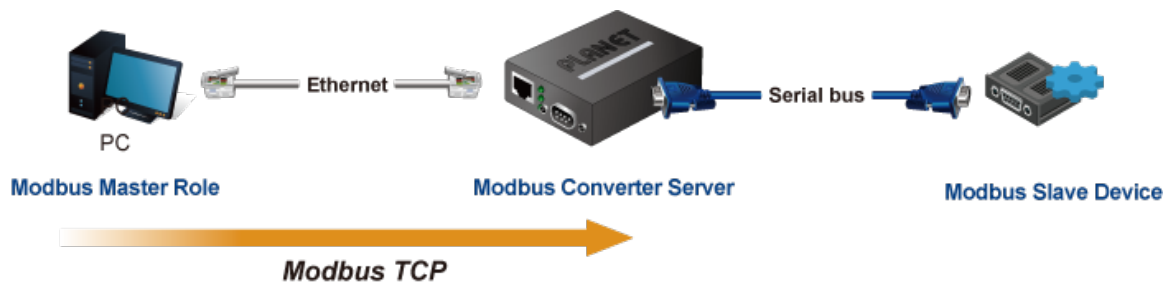

Figure 4-5-34: Modbus Converter Server mode Topology

The Modbus Converter Server mode screenshot in [Figure 4-5-35](#) appears.

Operation Mode:	Modbus Converter Server Mode ▾
TCP Keep-alive Interval:	0 (min)
Quiescent Time:	0 (0 - 65535 ms)
Max Connection:	1 ▾
Local TCP Port:	5004

Figure 4-5-35: Modbus Converter Server mode Screenshot

Object	Description
• TCP Keep-alive Interval	TCP keep alive interval shows how many seconds the unit waits during an inactive connection before checking its status. If the unit does not receive a response, it will drop that connection. The default is 0 minute.
• Quiescent Time	When the network connection is determined to be idle, the duration of the control network inactivity will cause the connection to be forced closed. The default value is 0.
• Max connection	This parameter set the TCP port number on which it will listen for the connection and set the maximum (up to two) acceptable number of connections. The range of value is from 1 to 4. The default is 1.
• Local TCP Port	Scope: 1 to 65535. Default: 5004 for port 1, 5005 for port 2 and so forth. This parameter is described the TCP port that communicates with the connected device. The setting slave and master destination IP parameters must use the same value to achieve communication.

4.5.2.10 Modbus Converter Client mode

The ICS Serial devices support standard Modbus protocol and various hardware interfaces (serial and Ethernet). Modbus TCP and RTU can be used to convert the Modbus protocol. The Modbus master can communicate with the serial network of devices connected to the serial port of the server converter via a server converter.

The meter receives Modbus TCP / IP data on TCP port 502, translates it to a Modbus RTU, and then forwards it to the addressed slave device.

Functionally allows monitoring software to access information from slaves for trend analysis, data collection, alarm/event management, maintenance and other functions. The Modbus Converter Client topology in [Figure 4-5-36](#) appears.

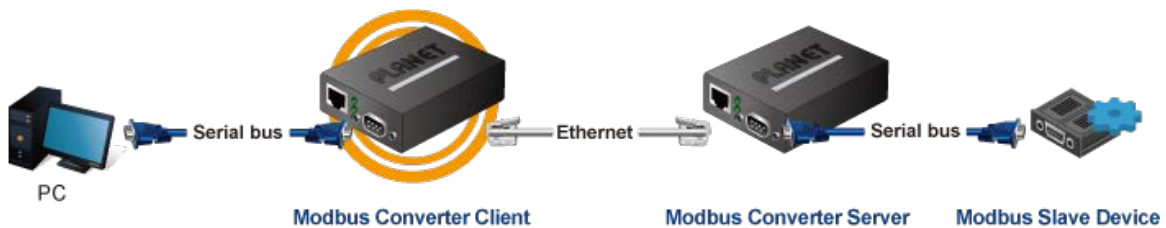

Figure 4-5-36: Modbus Converter Client mode Topology

The Modbus Converter Client mode screenshot in [Figure 4-5-37](#) appears.

Operation Mode: ▼

TCP Keep-alive Interval: (min)

Quiescent Time: (0 - 65535 ms)

Connection Target IP Address	
Target IP 1:	<input type="text"/> : <input type="text" value="5004"/>
Target IP 2:	<input type="text"/> : <input type="text" value="5004"/>
Target IP 3:	<input type="text"/> : <input type="text" value="5004"/>
Target IP 4:	<input type="text"/> : <input type="text" value="5004"/>

Assigned Local Port (0 - 65535)	
Port 1:	<input type="text" value="5004"/>
Port 2:	<input type="text" value="5004"/>
Connection Control:	<input type="text" value="Startup/None"/> ▼ (Connect on/Disconnect by)

Figure 4-5-37: Modbus Converter Client mode Screenshot

Object	Description
<ul style="list-style-type: none"> TCP Keep-alive Interval 	TCP keep alive interval shows how many seconds the unit waits during an inactive connection before checking its status. If the unit does not receive a response, it will drop that connection. The default is 0 minute.
<ul style="list-style-type: none"> Quiescent Time 	When the network connection is determined to be idle, the duration of the control network inactivity will cause the connection to be forced closed. The default value is 0.

Connection Target IP address

Object	Description
<ul style="list-style-type: none"> • Target IP address 1 through 4 	<p>IP addresses are used to deliver packets of data across a network and have what is termed end-to-end significance. The network data is sent to the device in a first-in, first-out (FIFO) method. During data transfer phase, data is transmitted sequentially through established path-arriving at the destination in the order in which it was sent.</p>

Assign Local Port

Object	Description
<ul style="list-style-type: none"> • Local listen port 	<p>The range of value is from 1 to 65535. The default is 5004 for port 1, 5005 for port 2, 5006 for port 3 and , 5007 for port 4.</p>
<ul style="list-style-type: none"> • Connection control 	<p>The default is Startup/None.</p> <ul style="list-style-type: none"> ■ Startup/None ■ Any Character/None ■ Any Character/Quiescent time ■ DCD On/DCD Off ■ DCD On/None ■ DSR On/DSR Off ■ DSR On/None

4.6 SNMP Setup

Use the Port Menu to display or configure the Serial Server's ports. This section includes the page that displays current port configurations. Ports can also be configured here. The Port Configuration screen in [Figure 4-6-1](#) appears.

SNMP Setup

SNMP Active:	Disable ▾
Community:	public
Contact:	defaultContact
Location:	defaultLocation
Trap Server:	localhost IP or domain name

Events:	
Cold Start Trap:	<input type="checkbox"/>
Warm Start Trap:	<input type="checkbox"/>
Authentication Failure Trap:	<input type="checkbox"/>

Figure 4-6-1: SNMP Setup page Screenshot

The page includes the following fields:

Object	Description
• SNMP Active	Indicates the SNMP mode operation. Possible modes are: <ul style="list-style-type: none"> ■ Disable: Disable SNMP mode operation. ■ Enable: Enable SNMP mode operation.
• Community	Indicates the security name to map the community to the SNMP Groups configuration.
• Contact	The textual identification of the contact person for this managed node, together with information on how to contact this person.
• Location	The physical location of this node (e.g., telephone closet, 3rd floor).
• Trap Server	Indicates the SNMP trap destination address. It allows a valid IP address or domain name.

Events

Object	Description
• Cold Start Trap	This event is triggered when the power is interrupted and restarted.
• Warm Start Trap	This event occurs when the device is reset but does not turn off the power.
• Authentication Failure Trap	This event occurs when an incorrect or unauthorized password are entered.

4.7 Maintenance

Use the Port Menu to display or configure the Serial Server's ports. This section includes the page that displays current port configurations. Ports can also be configured here.

4.7.1 Change Password

After logging in to the serial server, user can make changes from the "Change Password" page. The Change Password screen in [Figure 4-7-1](#) appears.

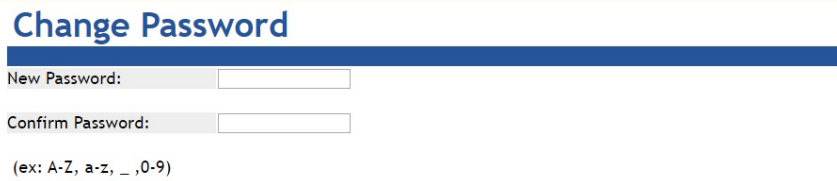

Figure 4-7-1: Change Password Page Screenshot

The page includes the following fields:

Object	Description
<ul style="list-style-type: none"> New Password 	A new password. It allows strings like A-Z, a-z, _ ,0-9
<ul style="list-style-type: none"> Confirm Password 	Please enter the user's new password here again to confirm.

4.7.2 Load Default

A user can reset the configuration of the serial server on this page. The new configuration will be applied after restarting the system. The Load Default screen in [Figure 4-7-2](#) appears.



Figure 4-7-2: Reset to Default Page Screenshot

Buttons

Apply: Click to reset to default.

4.7.3 Firmware Update

This page facilitates an update of the firmware controlling the switch. The Firmware Update screen in [Figure 4-7-3](#) appears.

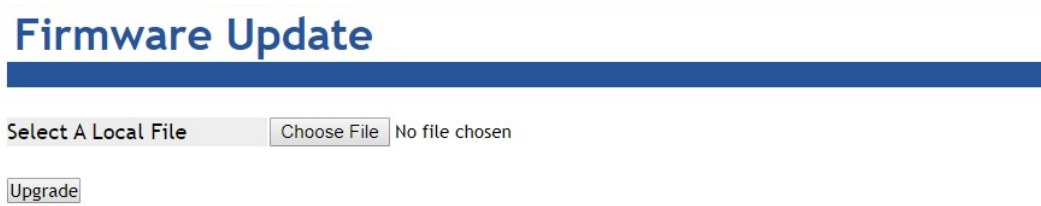

Figure 4-7-3: Firmware Update Page Screenshot

To open **Firmware Update** screen, perform the following:

1. Click **Maintenance** -> **Firmware Update**.
2. The Firmware Update screen is displayed as in [Figure 4-7-3](#).
3. Click the "**Choose File**" button of the Main page; the file selection menu pops up for you to choose firmware.
4. Select on the firmware, then click "**Upgrade**"; the **Software Upload Progress** would show the file with upload status.
5. Once the software is loaded to the system successfully, the following screen [Figure 4-7-4](#) appears. The system will load the new software after rebooting.

Information Note

Please wait while ...
System will reboot automatically after finished.

100 % , Rebooting ... 94 seconds

Figure 4-7-4: Rebooting Screenshot

4.8 Save and Restart

When applying any configuration changes of serial server, it's required to save changed configuration and reboot system. Therefore the new configuration will be applied after rebooting. The Save and Restart screen in [Figure 4-8-1](#) appears.

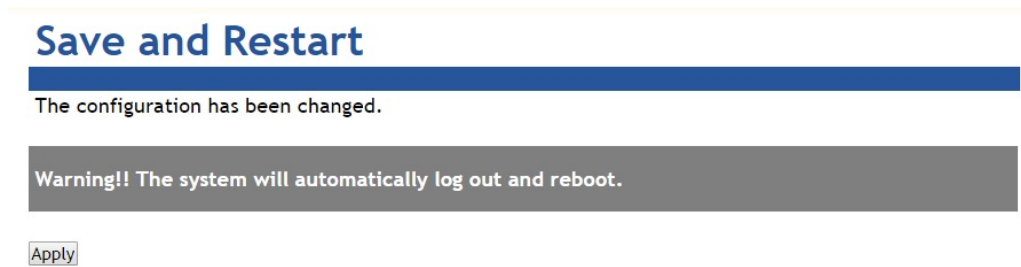



Figure 4-8-1 : Save and Restart Page Screenshot

Buttons

: Click to save changes and restart ststem.

5. SOFTWARE VCOM UTILITY

The serial server provides VCOM software to manage serial devices. With VCOM software, it's easy to install and configure serial server over the network. It also supports central management to manage multiple serial servers from one site.

Two function groups are provided and they are easy to use for searching device and creating virtual COM to view via the console port. VCOM software can search ICS-2100T, ICS-2105AT, ICS-2200T and ICS-2400T devices; it will show information of the device. And user can use VCOM function to create virtual COM port for users. Users can send data via virtual COM port, and virtual COM port will transfer data to Ethernet by windows socket. When VCOM gets data from Ethernet, data will be transferred to virtual COM port by virtual COM component.

5.1 Installing the VCOM Utility

1. When you run VCOM installer, a welcome window will appear as shown in [Figure 5-1-1](#). Click Next to continue.

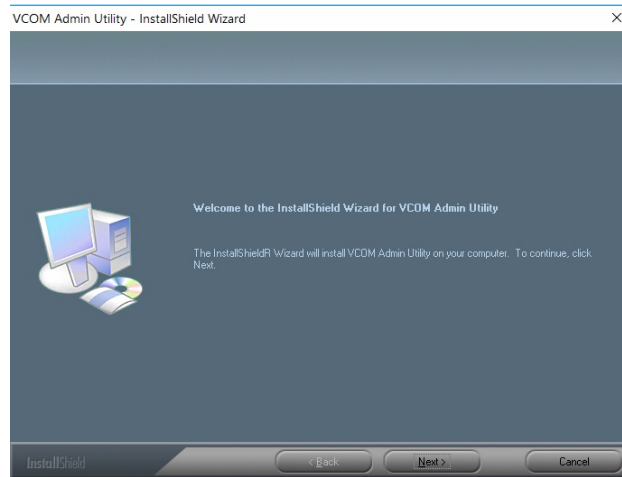

Figure 5-1-1 : Installing the VCOM Utility

2. Click Next to accept suggested installation path, or click browse to select a different location as shown in [Figure 5-1-2](#).

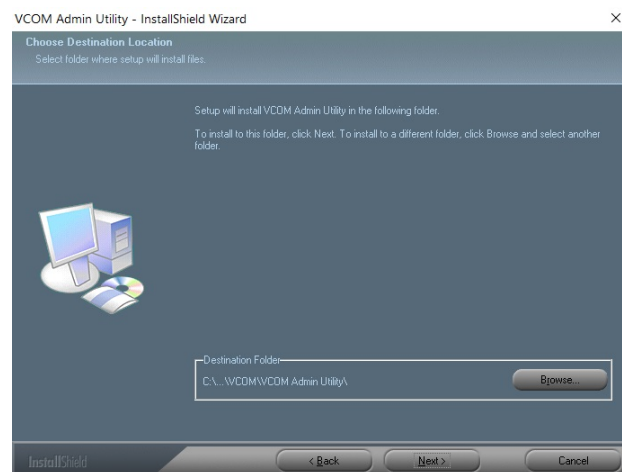

Figure 5-1-2 : Installing location

3. The setup wizard will show the progress of the installation and status as shown in [Figure 5-1-3](#).

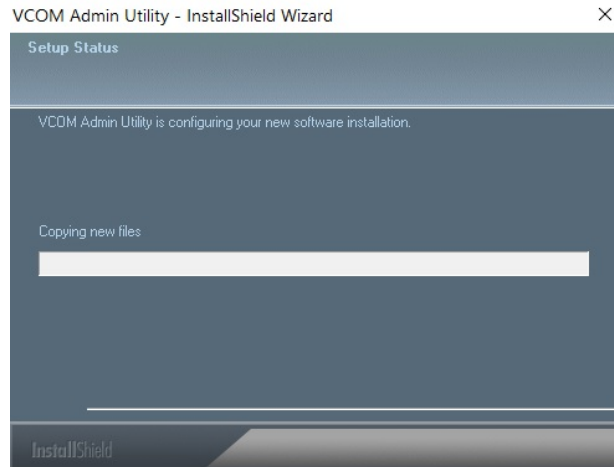

Figure 5-1-3 : Installing Process

4. Click Finish to successfully complete installation of VCOM software.as shown in [Figure 5-1-4](#).

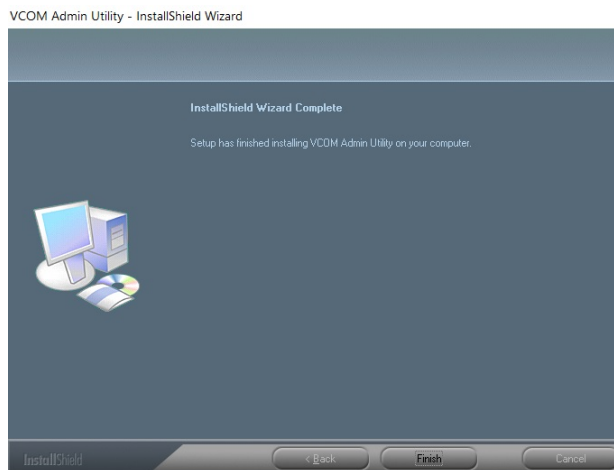

Figure 5-1-4 : Installation Finished

5. Restart computer as shown in [Figure 5-1-5](#).

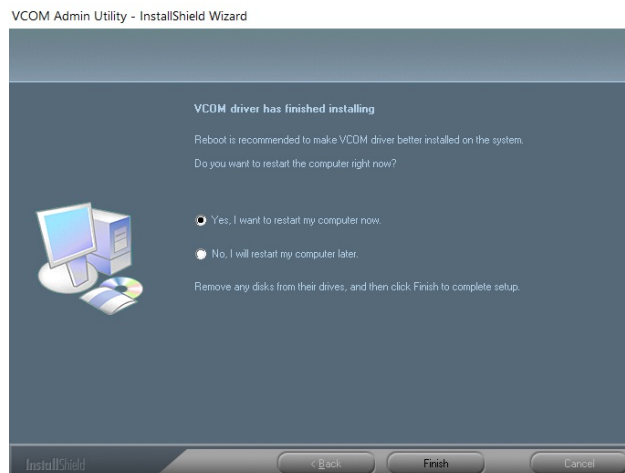

Figure 5-1-5 : Restart System

5.3 COM Port Mapping

This function should be set as **VCOM mode** on the serial server. VCOM software will create the corresponding virtual COM ports for com port mapping as shown in [Figure 5-3-1](#).

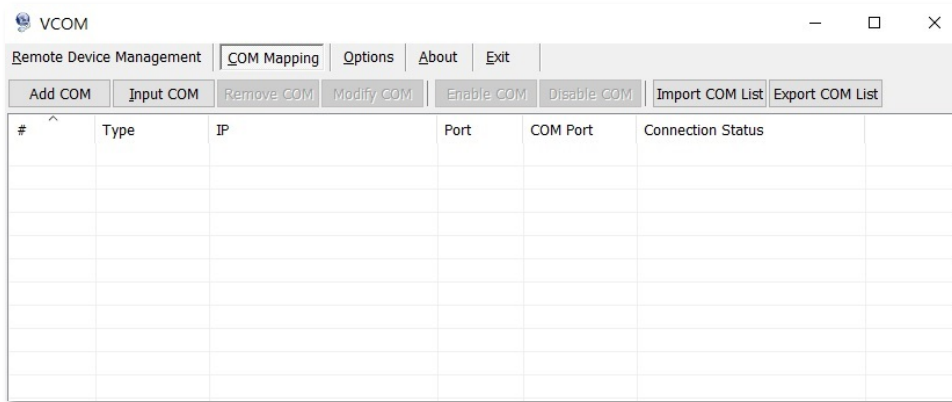

Figure 5-3-1 : VCOM software

Add Virtual COM port

1. Click "Search" to search the network for device servers.
2. Once a server has been found, select it to add it to the COM mapping list and Click "OK" to take effect as shown in [Figure 5-3-2](#).

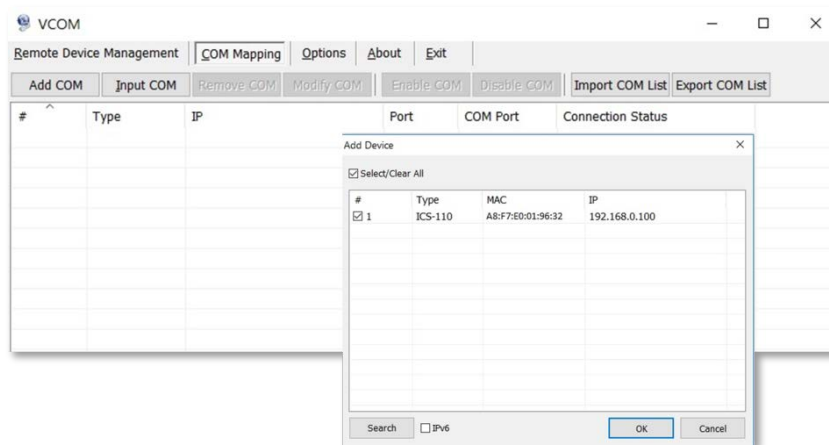

Figure 5-3-2 : VCOM software

3. Virtual com ports are generated as shown in [Figure 5-3-3](#).

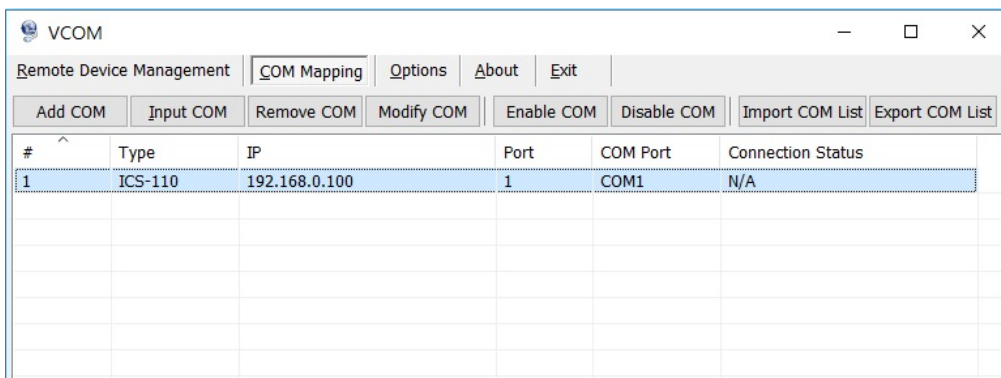

Figure 5-3-3 : Virtual COM Ports

4. From the Windows Device Manager, four COM Ports are added to the device list as shown in [Figure 5-3-4](#).

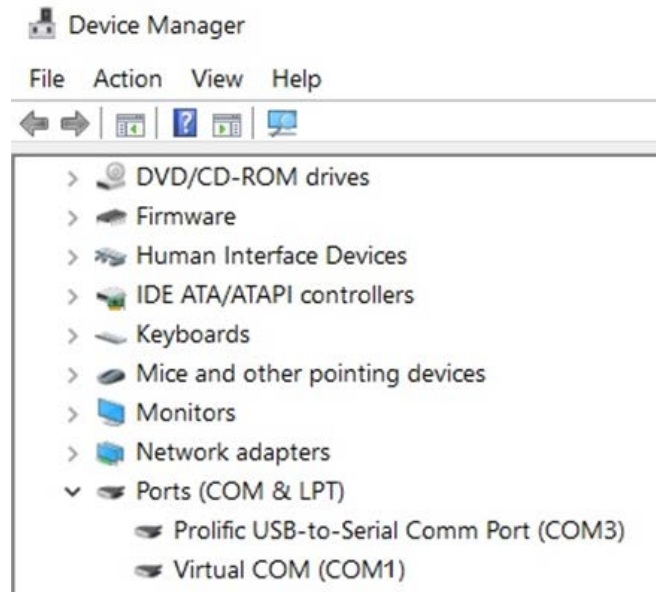

Figure 5-3-4 : Virtual COM Ports