

**8-Port 10/100TX 802.3at PoE +
2-Port 10/100TX Desktop Switch**

FSD-1008HP

User's Manual

Copyright

Copyright © 2017 by PLANET Technology Corp. All rights reserved. No part of this publication may be re-produced, transmitted, transcribed, stored in a retrieval system, or translated into any language or computer language, in any form or by any means, electronic, mechanical, magnetic, optical, chemical, manual or otherwise, without the prior written permission of PLANET.

PLANET makes no representations or warranties, either expressed or implied, with respect to the contents hereof and specifically disclaims any warranties, merchantability or fitness for any particular purpose. Any software described in this manual is sold or licensed "as is". Should the programs prove defective following their purchase, the buyer (and not PLANET, its distributor, or its dealer) assumes the entire cost of all necessary servicing, repair, and any incidental or consequential damages resulting from any defect in the software. Further, PLANET reserves the right to revise this publication and to make changes from time to time in the contents hereof without obligation to notify any person of such revision or changes.

All brand and product names mentioned in this manual are trademarks and/or registered trademarks of their respective holders.

Trademarks

PLANET is a registered trademark of PLANET Technology Corp.

All other trademarks belong to their respective owners.

Disclaimer

PLANET Technology does not warrant that the hardware will work properly in all environments and applications, and makes no warranty and representation, either implied or expressed, with respect to the quality, performance, merchantability, or fitness for a particular purpose.

PLANET has made every effort to ensure that this User's Manual is accurate; PLANET disclaims liability for any inaccuracies or omissions that may have occurred. Information in this User's Manual is subject to change without notice and does not represent a commitment on the part of PLANET. PLANET assumes no responsibility for any inaccuracies that may be contained in this User's Manual. PLANET makes no commitment to update or keep current the information in this User's Manual, and reserves the right to make improvements to this User's Manual and/or to the products described in this User's Manual, at any time without notice. If you find information in this manual that is incorrect, misleading, or incomplete, we would appreciate your comments and suggestions.

FCC Warning

This equipment has been tested and found to comply with the limits for a Class A digital device, pursuant to Part 15 of the FCC Rules. These limits are designed to provide reasonable protection against harmful interference when the equipment is operated in a commercial environment. This equipment generates, uses, and can radiate radio frequency energy and, if not installed and used in accordance with the Instruction manual, may cause harmful interference to radio communications. Operation of this equipment in a residential area is likely to cause harmful interference in which case the user will be required to correct the interference at his own expense.

CE Mark Warning

This is a Class A product. In a domestic environment, this product may cause radio interference, in which case the user may be required to take adequate measures.

WEEE Warning



To avoid the potential effects on the environment and human health as a result of the presence of hazardous substances in electrical and electronic equipment, end users of electrical and electronic equipment should understand the meaning of the crossed-out wheeled bin symbol. Do not dispose of WEEE as unsorted municipal waste and have to collect such WEEE separately.

Revision

PLANET 8-Port 10/100TX 802.3at PoE + 2-Port 10/100TX Desktop Switch User's Manual

For Model: FSD-1008HP

Revision: 1.0 (September 2017)

Part No.: EM-FSD-1008HP_v1.0

Table Of Contents

1. Introduction	5
1.1 Checklist.....	5
1.2 Product Description.....	5
1.3 Features	6
1.4 Specifications	7
2. Hardware Description	9
2.1 Front Panel	9
2.1.1 LED Indicators	11
2.2 Rear Panel	11
3. Hardware Installation	12
3.1 Desktop Installation	13
3.2 Rack Mounting	14
3.3 Wall Mounting Installation	15
4. Troubleshooting	17
Appendix A - 10/100Mbps, 10/100BASE-TX	18

1. Introduction

1.1 Checklist

Check the contents of your package for the following parts

<p>FSD-1008HP x 1</p> 	<p>User's Manual x 1</p> 
<p>Power Cord x 1</p> 	<p>Rubber Feet x 4</p> 
<p>Rack-mounting Brackets</p> 	<p>Screws Package x 8</p> 

If any of these pieces are missing or damaged, please contact your dealer immediately; if possible, retain the carton including the original packing material, and use them again to repack the product in case there is a need to return it to us for repair.

1.2 Product Description

To fulfill the demand of sufficient PoE power for network applications, PLANET FSD-1008HP 8-Port 10/100TX 802.3at PoE + 2-Port 10/100TX Desktop Switch, a new member of the 802.3at PoE Fast Ethernet Switch family, features up to 30

watts of power output for each port and a total PoE budget of 120 watts for eight 10/100Mbps TP ports, and two 10/100Mbps uplink ports. The eight 802.3at PoE+ ports provide PoE power injector function which is able to drive 8 IEEE 802.3at compliant powered devices. The FSD-1008HP also provides a simple, cost-effective, and non-blocking wire-speed performance with 9-inch metal housing suitable for desktop deployment for SOHO and department network applications.

All RJ45 copper interfaces in the FSD-1008HP support 10/100Mbps auto-negotiation for optimal speed detection through RJ45 Category5, 5e or 6 cables. It also supports standard auto-MDI/MDI-X that can detect the type of connection to any Ethernet device without requiring special straight-through or crossover cables.

1.3 Features

➤ Physical Port

- 10-port 10/100BASE-TX Fast Ethernet RJ45 copper
- 8-port IEEE 802.3at/af PoE Injector (Port-1 to Port-8)

➤ Power over Ethernet

- Complies with IEEE 802.3af/at Power over Ethernet end-span PSE
- Up to 8 ports of IEEE 802.3af/802.3at devices powered
- Supports PoE Power up to 30.8 watts for each PoE port
- Each port supports 55V DC power to PoE powered device
- 120-watt PoE budget
- Auto detects powered device (PD)
- Circuit protection prevents power interference between ports
- Remote power feeding up to 100m in standard mode with 250m in extended mode

➤ Switching

- Hardware-based 10/100Mbps auto-negotiation and auto MDI/MDI-X
- Flow control for full duplex operation and back pressure for half duplex operation
- IEEE 802.1Q VLAN transparency
- Hardware DIP switch for **Standard**, **VLAN** and **Extend** mode selection; the Extend mode features 30-watt PoE transmit distance of 250m at speed of 10Mbps and VLAN isolation (Only for Port-1 to Port-8)
- Solid DIP switch to isolate ports to prevent broadcast storm and defend DHCP spoofing

➤ Hardware

- 9-inch desktop size, 1U height, rack mountable
- LED indicators for system power, per port PoE ready and PoE activity, speed, Link/Act
- Fanless design
- Supports Energy-Efficient Ethernet (EEE) function (IEEE 802.3az)

1.4 Specifications

Model	FSD-1008HP
Hardware Specifications	
Copper Port	10 10/100/BASE-TX MDI/MDIX Ports
PoE Injector Port	8-port with 802.3at/af PoE injector function with Port-1 to Port-8
Switch Architecture	Store-and-Forward
Switch Fabric	2Gbps/non-blocking
Switch Throughput@64 bytes	1.48Mpps@64 bytes
MAC Address Table	8K entries, automatic source address learning and aging
Maximum Frame Size	1522 bytes
Flow Control	IEEE 802.3x pause frame for full-duplex Back pressure for half-duplex
LED	System: ■ Power (Green) 10/100BASE-TX RJ45 interfaces: ■ 10/100Mbps LNK/ACT (Green) PoE interfaces: ■ PoE-in-Use (Orange)
DIP Switch	Selectable operation mode ■ Standard ■ VLAN ■ Extend
Dimensions (W x D x H)	220 x 150 x 43 mm (1U height)
Enclosure	Metal

Weight	1230 g
Power Requirements	AC 100~240V, 50/60Hz, 2.5A max
Power Consumption/Dissipation	Max. 120 watts/409.4 BTU
Thermal Fan	Fanless
Power over Ethernet	
PoE Standard	IEEE 802.3af Power over Ethernet/PSE IEEE 802.3at Power over Ethernet Plus/PSE
PoE Power Supply Type	End-span
PoE Power Output	Per port 55V DC, 540mA. max. 30 watts
Power Pin Assignment	1/2(+), 3/6(-)
PoE Power Budget	120 watts
Max. Number of Class 2 PDs	8
Max. Number of Class 3 PDs	8
Max. Number of Class 4 PDs	8
Standards Conformance	
Regulatory Compliance	FCC Part 15 Class A, CE
Standards Compliance	IEEE 802.3 10BASE-T IEEE 802.3u 100BASE-TX IEEE 802.3x Flow control and back pressure IEEE 802.3af Power over Ethernet IEEE 802.3at Power over Ethernet Plus IEEE 802.3az Energy Efficient Ethernet (EEE)
Environment	
Operating	Temperature: 0 ~ 50 degrees C Relative Humidity: 5 ~ 95% (non-condensing)
Storage	Temperature: -10 ~ 70 degrees C Relative Humidity: 5 ~ 95% (non-condensing)

2. Hardware Description

The switch provides two different running speeds – 10Mbps and 100Mbps, and automatically distinguishes the speed of the incoming connection.

This section describes the hardware features of the FSD-1008HP. For easier management and control of the FSD-1008HP, familiarize yourself with its display indicators and ports. Front panel illustrations in this chapter display the unit LED indicators. Before connecting any network device to the FSD-1008HP, please read this chapter carefully.

2.1 Front Panel

The Front Panel of the FSD-1008HP PoE+ Ethernet Switch consists of 10 Auto-Sensing 10/100Mbps Ethernet RJ45 Ports. The LED Indicators are also located on the front panel of the FSD-1008HP.

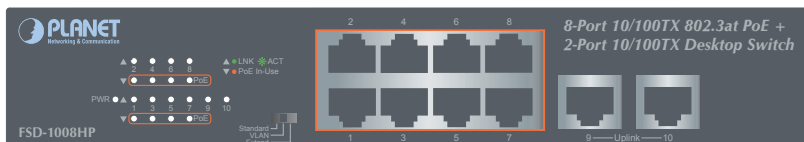



Figure 2-1: FSD-1008HP Switch Front Panel

The front panel of FSD-1008HP provides one DIP switch for **Standard**, **VLAN** and **Extend** mode selections. The detailed descriptions are shown in the following table.

DIP Switch Mode	Function
 <p>Standard VLAN Extend</p>	<p>This mode makes the FSD-1008HP operate as a general switch and all PoE ports operate at 10/100Mbps auto-negotiation.</p>
 <p>Standard VLAN Extend</p>	<p>This mode makes the FSD-1008HP operate as a VLAN isolation switch and</p> <ol style="list-style-type: none"> 1.Port 1 to port 8 will isolate respectively. 2.Port 1 to port 8 can only communicate with port 9 and port 10 (uplink port).

Standard
VLAN
Extend



This mode makes the FSD-1008HP operate as a VLAN isolation switch and

- 1.Port 1 to port 8 will isolate respectively.
- 2.Port 1 to port 8 can only communicate with port 9 and port 10 (uplink port).
- 3.30-watt PoE transmit distance of 250m at speed of 10Mbps.



Note

Please reboot the FSD-1008HP after adjusting the DIP switch.

Default PoE Mode

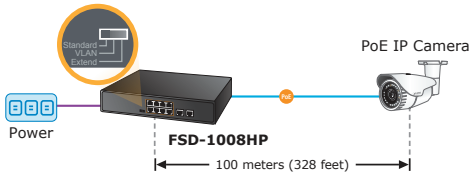

VLAN Isolation Mode

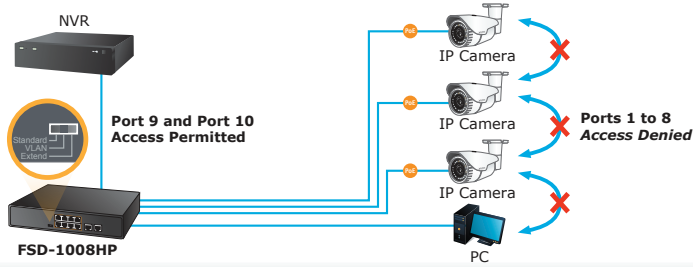

Extended PoE Mode

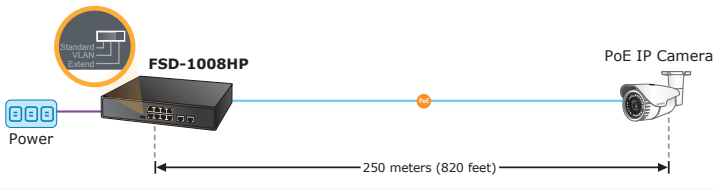

- 10BASE-T UTP with PoE
- 100BASE-TX UTP
- 100BASE-TX UTP with PoE

2.1.1 LED Indicators

System

LED	Color	Function
PWR	Green	Lights to indicate that the Switch has power.

Per 10/100Mbps Port

LED	Color	Function
PoE-in-use	Orange	Lights to indicate the port is providing 55V DC in-line power. (1-8 ports)
Speed/ LNK/ACT	Green	Lights to indicate the Switch is successfully connecting to the network at 10/100Mbps. Blinks to indicate that the Switch is actively sending or receiving data over that port.

2.2 Rear Panel

The rear panel of the FSD-1008HP has an AC inlet power socket, which accepts input power of 100 to 240V AC, 50-60Hz.



Figure 2-2: FSD-1008HP Switch Rear Panel



Power Note

1. The device is a power-required device which means it will not work till it is powered. If your networks should be active all the time, please consider using UPS (Uninterrupted Power Supply) for your device. It will prevent you from network data loss or network downtime.
2. In some areas, installing a surge suppression device may also help to protect your FSD-1008HP from being damaged by unregulated surge or current to the FSD-1008HP.

3. Hardware Installation

Start up

Please refer to the following for your cabling:

■ 10/100BASE-TX

All 10/100BASE-TX ports come with Auto-Negotiation capability. They automatically support 100BASE-TX and 10BASE-T networks. Users only need to plug a working network device into one of the 10/100 BASE-TX ports, and then turn on the FSD-1008HP. The port will automatically run in 10Mbps, 20Mbps, 100Mbps or 200Mbps after the negotiation with the connected device.

■ Cabling

Each of the 10/100BASE-TX ports uses RJ45 sockets -- similar to the phone jacks -- for connection of un-shielded twisted-pair cable (UTP). The IEEE 802.3/802.3u Fast Ethernet standard requires Category 5 UTP for 100Mbps 100BASE-TX. 10BASE-T networks can use Cat.3, 4, 5 or 6 UTP (see table below). Maximum distance is 100 meters (328 feet).

Port Type	Cable Type	Connector
10BASE-T	Cat.3, 4, 5, 2-pair	RJ45
100BASE-TX	Cat.5, 5e UTP, 4-pair	RJ45

Any Ethernet devices like hubs/PCs can be connected to the FSD-1008HP by using straight-through wires. The whole 10/100Mbps ports are auto-MDI/MDI-X that can be used on straight-through or crossover cable.

3.1 Desktop Installation

To install the FSD-1008HP on desktop, simply follow the following steps:

Step 1: Attach the rubber feet to the recessed areas on the bottom of the FSD-1008HP, as shown in Figure 3-1.

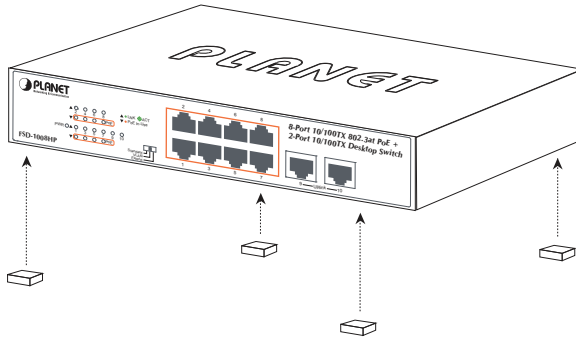

Figure 3-1: Attaching the Rubber Feet to the FSD-1008HP

Step 2: Place the FSD-1008HP on desktop near an AC power source.

Step 3: Keep enough ventilation space between the FSD-1008HP and the surrounding objects.



Note

When choosing a location, please keep in mind the environmental restrictions discussed in Chapter 1, Section 4, under Specifications.

Step 4: Connect your FSD-1008HP to 802.3af/802.3at complied power devices (PD) and other network devices

- A.** Connect one end of a standard network cable to the 10/100BASE-TX RJ45 ports on the front panel of the FSD-1008HP.
- B.** Connect the other end of the cable to the network devices such as printer servers, workstations, routers, etc.



Note

Connection to the Switch requires UTP Category 5, 5e, 6 network cabling with RJ45 tips.

Step 5: Supply power to the FSD-1008HP.

A. Connect one end of the power cable to the FSD-1008HP.

B. Connect the power plug of the power cable to a standard wall outlet.

When the FSD-1008HP receives power, the Power LED should remain solid Green.

3.2 Rack Mounting

To install the FSD-1008HP in a 19-inch standard rack, follow the instructions described below.

Step 1: Place your FSD-1008HP on a hard flat surface, with the front panel positioned towards your front side.

Step 2: Attach a rack-mount bracket to each side of the FSD-1008HP with supplied screws attached to the package. Figure 3-2 shows how to attach brackets to one side of the FSD-1008HP.

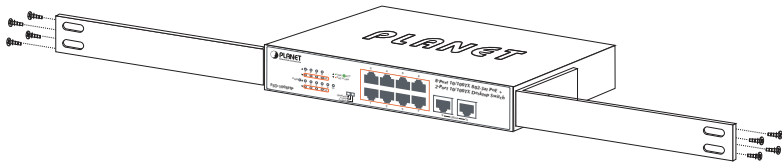

Figure 3-2: Attaching the Brackets to the FSD-1008HP.



You must use the screws supplied with the mounting brackets. Damage caused to the parts by using incorrect screws would invalidate the warranty.

Step 3: Secure the brackets tightly.

Step 4: Follow the same steps to attach the second bracket to the opposite side.

Step 5: After the brackets are attached to the FSD-1008HP, use suitable screws to securely attach the brackets to the rack, as shown in Figure 3-3.

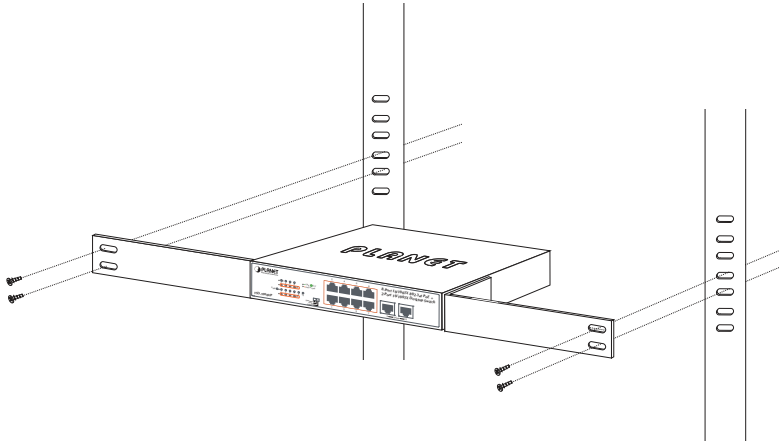

Figure 3-3: Mounting the FSD-1008HP in a Rack

Step 6: Proceed with Steps 4 and 5 of session 3.1 Desktop Installation to connect the network cabling and supply power to your Switch.

3.3 Wall Mounting Installation

Step 1: Please find the wall that can mount the FSD-1008HP.

Step 2: Install two screws on the wall.

Step 3: Hang the FSD-1008HP on the screws from the wall.

Step 4: Repeat step 5 of Desktop Installation for power supply to the FSD-1008HP.



Note

Before mounting the device to the wall, please check the location of the electrical outlet and the length of the Ethernet cable.

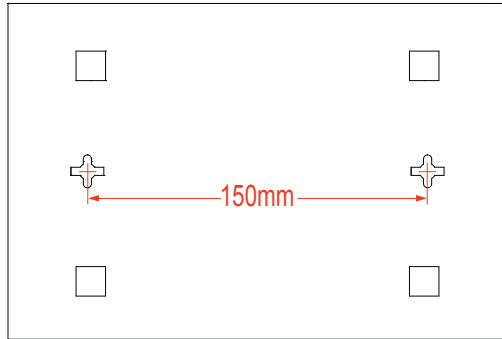

FSD-1008HP Switch Bottom Side

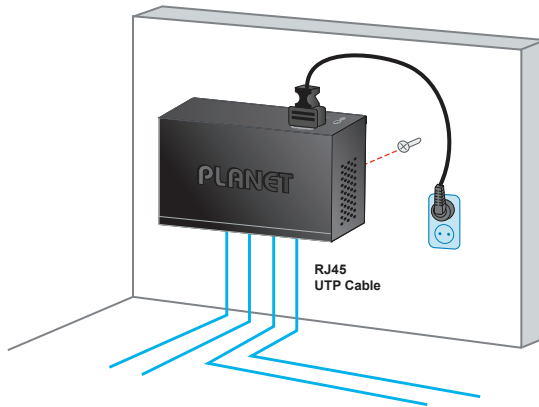

4. Troubleshooting

This chapter contains information to help you solve issues. If the FSD-1008HP is not functioning properly, make sure the FSD-1008HP was set up according to instructions in this manual.

Q1: The Link LED is not lit.

Solution:

Check the cable connection and also try to swap one new cable.

Q2: 100BASE-TX port link LED is lit, but the traffic is irregular.

Solution:

Make sure the attached device is not set to full duplex. Some devices use a physical or software switch to change duplex modes. Auto-negotiation may not recognize this type of full-duplex setting.

Q3: Why the Switch isn't connected to the network.

Solution:

Check the LNK/ACT LED on the FSD-1008HP. Try another port on the FSD-1008HP. Make sure the cable is installed properly. Make sure the cable is the right type. Turn off the power. After a while, turn on the power again

Q4: Why the FSD-1008HP, connected to PoE device, cannot be powered on.

Solution:

Please check the cable type of the connection from the FSD-1008HP to the other end. The cable should be an 8-wire UTP, Category 5 or above and EIA568 cable within 100 meters. A cable with only 4-wire, short loop or over 100 meters will affect the power supply.

Please make sure the device is fully complied with IEEE 802.3af/IEEE 802.3at standard.

Q5: What is the power output of each PoE port?

Solution:

1. Each PoE port supports 53-55V DC, 540mA and a maximum of 30 watts of power output. Detect and inject by the standard of IEEE 802.3at.
2. Each PoE port supports 53-55V DC, 290mA and a maximum of 15.4 watts of power output. Detect and inject by the standard of IEEE 802.3af.

Appendix A - 10/100Mbps, 10/100BASE-TX

When connecting Switch to another Fast Ethernet switch, a straight-through or crossover cable might be necessary. Each port of the Switch supports auto-MDI/MDI-X detection, meaning you can directly connect the Switch to any Ethernet devices without making a crossover cable. The following table and diagram show the standard RJ45 receptacle/connector and their pin assignments:

RJ45 Connector Pin Assignment		
Contact	MDI Media Dependent Interface	MDI-X Media Dependent Interface-Cross
1	Tx + (transmit)	Rx + (receive)
2	Tx - (transmit)	Rx - (receive)
3	Rx + (receive)	Tx + (transmit)
4, 5	Not used	
6	Rx - (receive)	Tx - (transmit)
7, 8	Not used	

The standard cable, RJ45 pin assignment

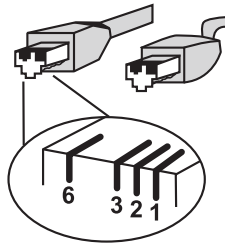

The standard RJ45 receptacle/connector

There are 8 wires on a standard UTP/STP cable and each wire is color-coded. The following shows the pin allocation and color of straight-through cable and crossover cable connection:

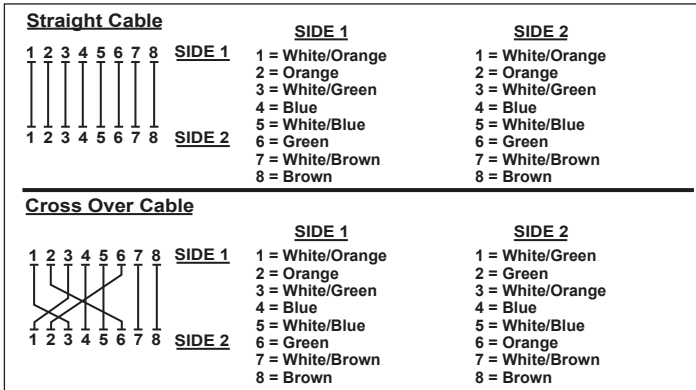

Figure A-1: Straight-through and Crossover Cable

Please make sure your connected cables are with the same pin assignment and color as the above description before deploying the cables into your network.

