

SmartAX EA5800-X15 Quick Installation Guide

Issue: 01
Date: 2017-05-08

HUAWEI TECHNOLOGIES CO., LTD.







About This Document

Intended Audience

This document describes how to install the EA5800-X15.
The intended audience is hardware installation engineers.

Symbol Conventions

The symbols that may be found in this document are defined as follows.

Symbol	Description
 DANGER	Indicates an imminently hazardous situation which, if not avoided, will result in death or serious injury.
 WARNING	Indicates a potentially hazardous situation which, if not avoided, could result in death or serious injury.
 NOTICE	Indicates a potentially hazardous situation which, if not avoided, may result in minor or moderate injury.
 CAUTION	Indicates a potentially hazardous situation which, if not avoided, could result in equipment damage, data loss, performance deterioration, or unanticipated results. NOTICE is used to address practices not related to personal injury.
 NOTE	Calls attention to important information, best practices and tips. NOTE is used to address information not related to personal injury, equipment damage, and environment deterioration.

Change History

Updates between document issues are cumulative. Therefore, the latest document issue contains all updates made in previous issues.

Updates in Issue 01 (2017-05-08)

This is the first release.

1 Precautions1

2 Tools and Meters.....2

3 Appearance and Structure.....3

4 Environment Requirements on Third-Party Cabinets4

5 Space Requirements on Third-Party Cabinets5

 5.1 When the Cabinet Accommodates One EA5800-X15 Subrack.....5

 5.2 When the Cabinet Accommodates One EA5800-X15 Subrack and Another Device..6

6 Installing the Service Subrack.....7

7 Routing Cable8

 7.1 Cabinet with Routed Cables.....8

 7.2 Routing the External Power Cables and PGND Cable.....9

 7.3 Routing the Power Cables and PGND Cable of the Equipment10

 7.4 Routing Clock Cables.....11

 7.5 Routing Network Cable.....12

 7.6 Routing Optical Fibers (Upstream).....13

 7.7 Routing Optical Fibers (P2P Board).....14

 7.8 Routing Optical Fibers (GPON Board).....15

8 Post-Installation Check.....16

9 Powering on the System.....17



1 Precautions



NOTE

- This document aims to provide simple and distinctive guidelines for hardware installation.
- This document does not describe operations for the pre-delivery installation. Instead, this document describes only the operations for on-site installation.

Electrostatic Discharge

Before touching the device, or holding the boards and IC chips, wear the ESD gloves or the ESD wrist strap to prevent the electrostatic discharge of the human body from damaging the sensitive components. Ensure that the other end of the ESD wrist strap is properly grounded.



ESD gloves

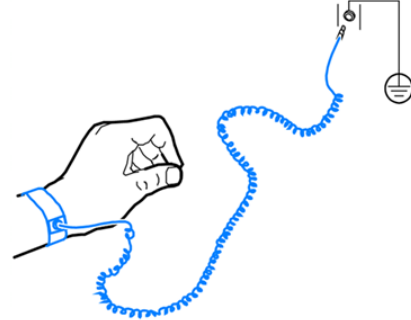

ESD wrist strap

Bundling cables

- The distance between cable ties or binding straps inside the cabinet must be within 250 mm. (For user cable, the distance must be within 200 mm.)
- Use diagonal pliers to cut off the extra part of the cable tie to the end, and ensure that the cable tie is neat without sharp edges to prevent hand injury.

Affixing labels / tags

- After routing the cable, attach the label or fasten the tag to the cable 20 mm away from the connector.
- After the label for the signal cable is attached to the signal cable, the rectangular text area of the label must face rightwards or downwards.
- After the identification plate for the power cable is attached to the power cable, the text area of the plate must face rightwards or upwards. Ensure that the side attached with the label faces outwards.



2 Tools and Meters

Before you begin, get the following tools ready.



Marker



Flat-head screwdriver



Phillips screwdriver



Diagonal pliers



Network cable crimping tool



Network cable tester



Multimeter



Optical power meter



ESD gloves



ESD wrist strap



Optical fiber microscope



Optical fiber cleaner



3 Appearance and Structure

NOTE

The EA5800-X15 service subrack, 11U high and 19 inches wide, has 20 slots and a fan tray on the top. The subrack is installed in the cabinet through the IEC mounting ears.

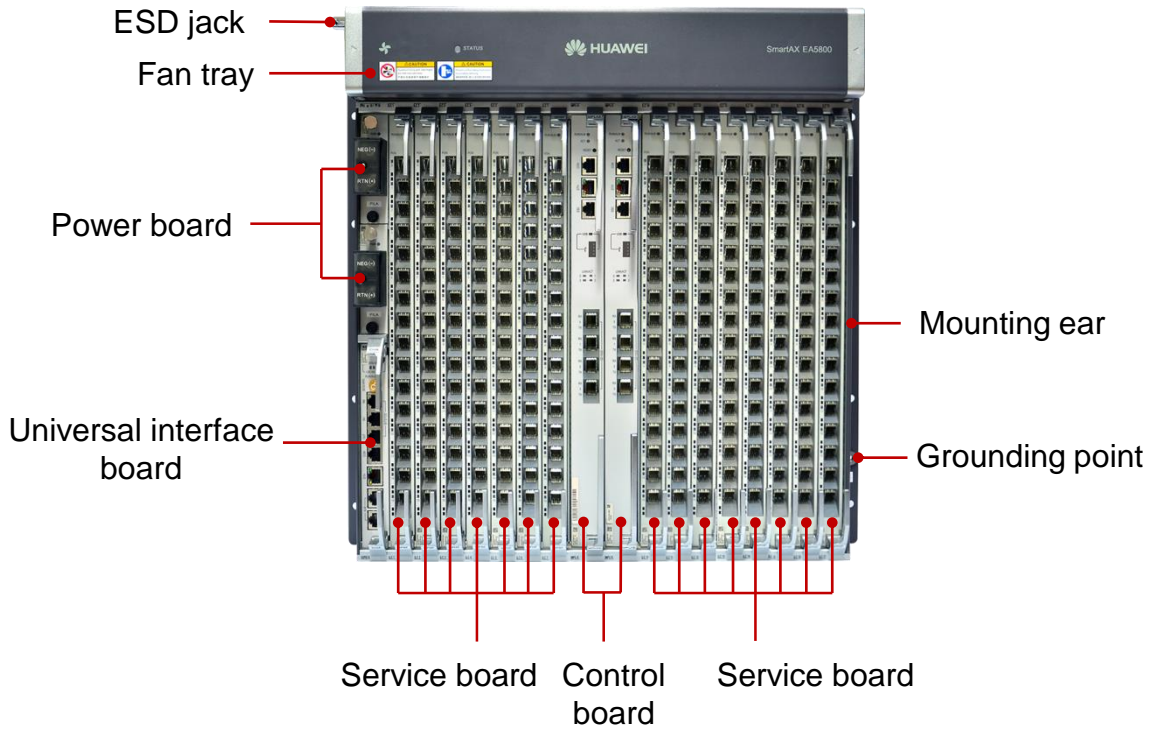

Unit: mm

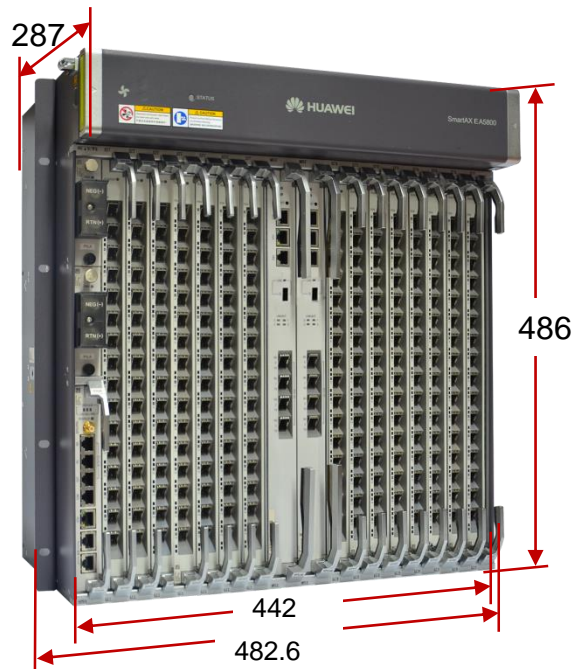



4 Environment Requirements on Third-Party Cabinets



NOTICE

- **Cabinet dustproof requirement:** The EA5800-X15 subrack is not dustproof, so select dustproof cabinets that support dust filter maintenance.
- **Cabinet installation requirements:**
 - For the EA5800-X15, select an IEC60297-compliant cabinet with a depth of 300 mm or more so that a space with a depth of 55 mm or more can be reserved for cable/fiber routing after boards are installed.
- **Cabinet door requirement:** When devices are operating, keep the cabinet door closed.
- **Grounding requirement:** Huawei cabinets are grounded through mounting bars. Ensure that third-party cabinets are properly grounded based on site conditions.
- **Power distribution requirements:** Ensure that an over-current protection mechanism has been deployed on the upper-level device. A 60-A over-current protection mechanism is recommended for the EA5800-X15. Ensure that the circuit breaker trip value of the upper-level device is greater than or equal to the rated value on the device nameplate.
- **Heat dissipation requirements:**
 - Ensure that the cabinet has an air inlet and the hole density of the cabinet door is 60% or higher.
 - When a cabinet accommodates multiple subracks or the device shares a cabinet with other active devices, ensure that the following space requirements are met.



5.1 When the Cabinet Accommodates One EA5800-X15 Subrack



NOTICE

- Reserve at least 2 U space for air flow-in when you route fibers or install other passive devices. You are advised to reserve more than 4 U space to facilitate subsequent air inlet or dust filter cleaning.

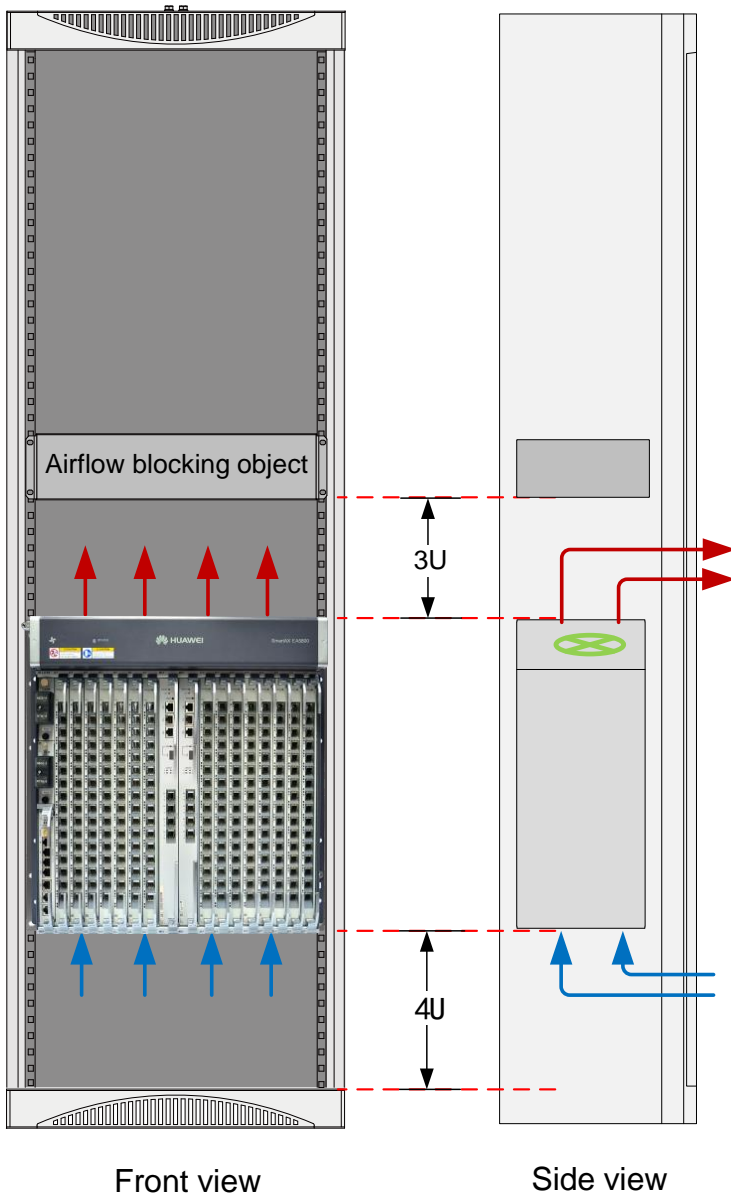

NOTE

- The heat dissipation of the EA5800-X15 is assured only when more than 2 U space is reserved at the air inlet and 3 U space is reserved at the air outlet.
- You are advised to reserve more than 4 U space above and under the EA5800-X15 respectively to minimize the impact on other components in the cabinet.



5.2 When the Cabinet Accommodates One EA5800-X15 Subrack and Another Device

- NOTICE**
- Reserve 10 U space between the devices or add a 3 U air deflector to redirect air flows to minimize the mutual heat dissipation impacts on the devices.
 - Reserve at least 2 U space for air flow-in when you route fibers or install other passive devices. You are advised to reserve more than 4 U space to facilitate subsequent air inlet or dust filter cleaning.

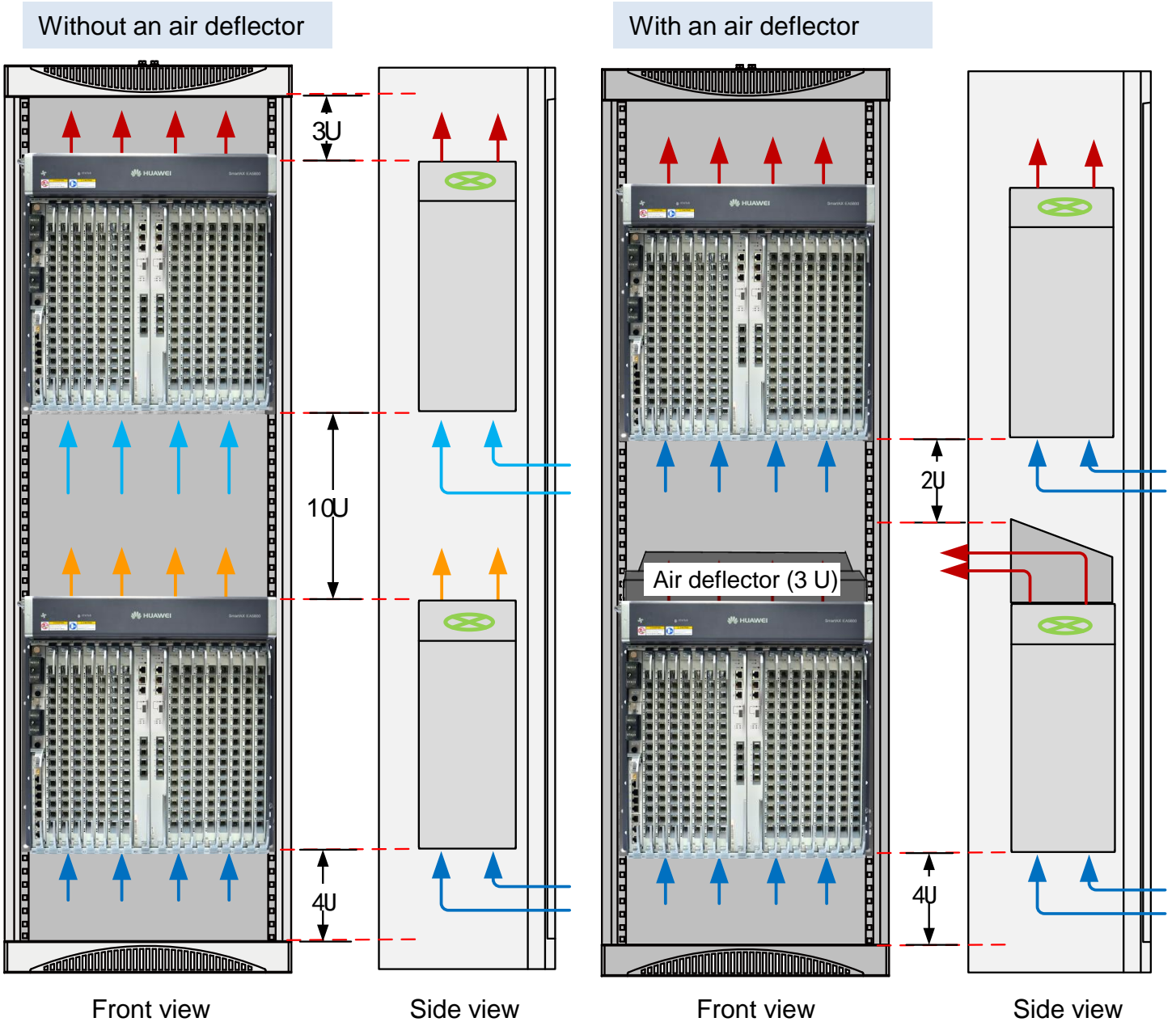



6 Installing the Service Subrack

- 1 Determine the location of floating nuts by using the installation template.

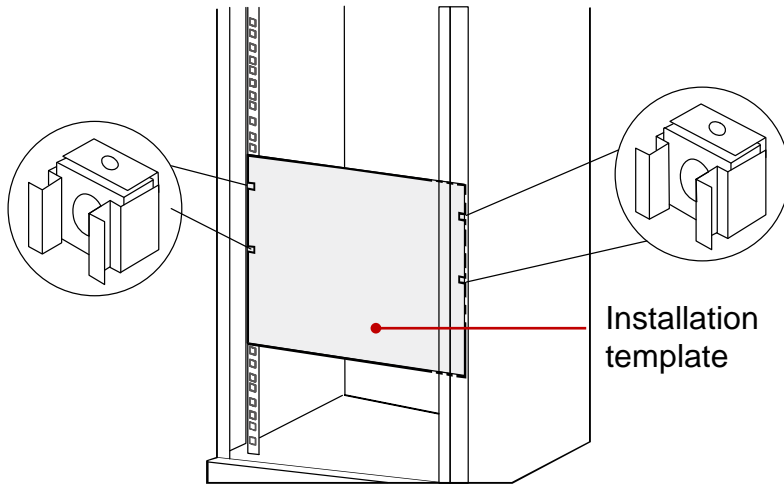

- 2 Locate the installation positions of the cable manager and service subrack on the mounting bars, and install captive nuts at these positions.

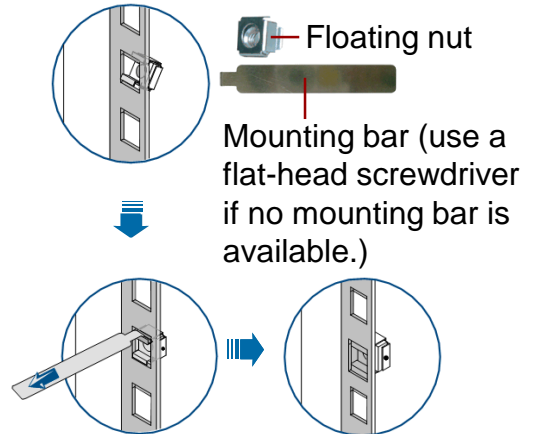

- 3 Install the upper and lower cable manager.

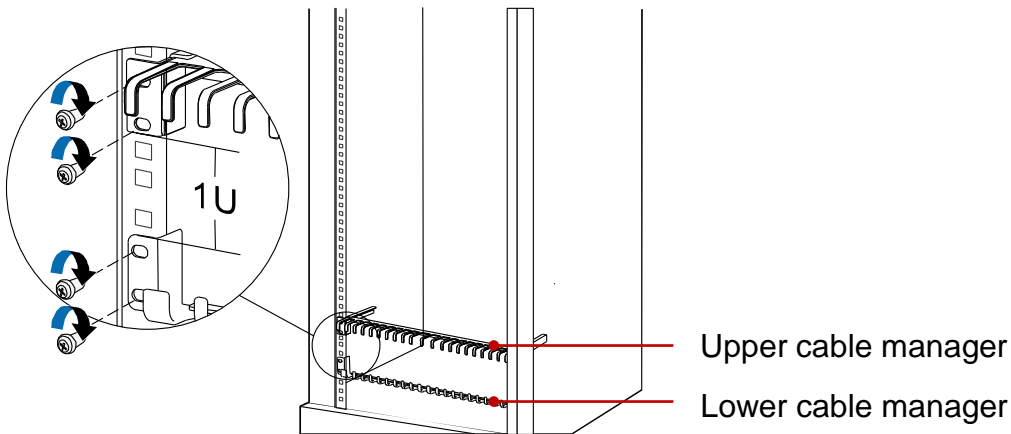

- 4 Install the service subrack.

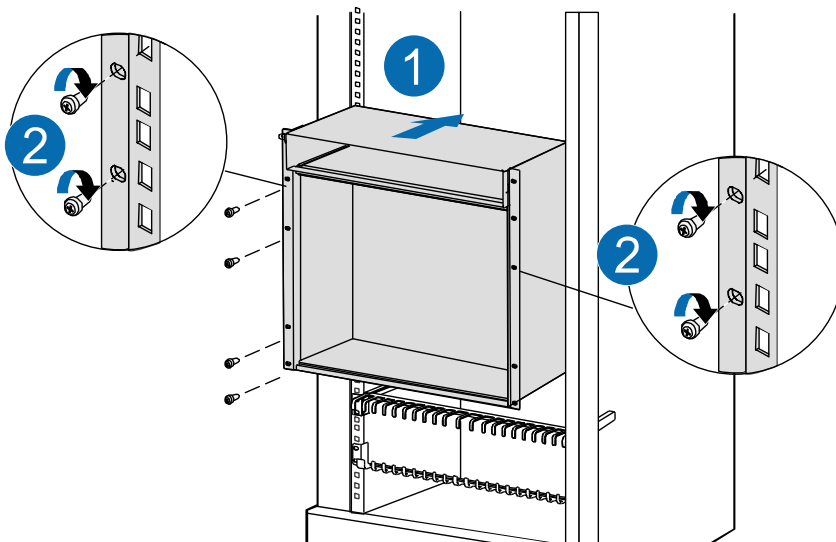

Phillips screwdriver



7.1 Cabinet with Routed Cables

Cabinet configured with 2 EA5800-X15 subracks

Installation positions for floating nuts

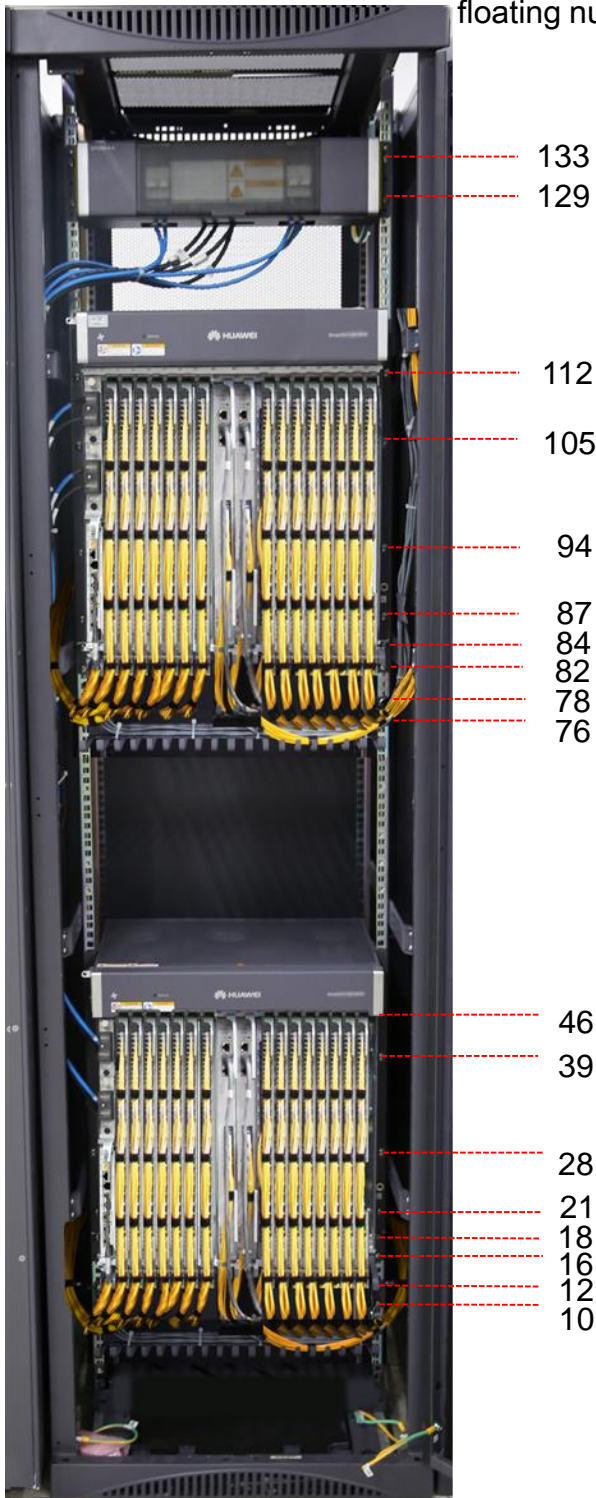

Cabinet configured with a EA5800-X15 subrack

Installation positions for floating nuts

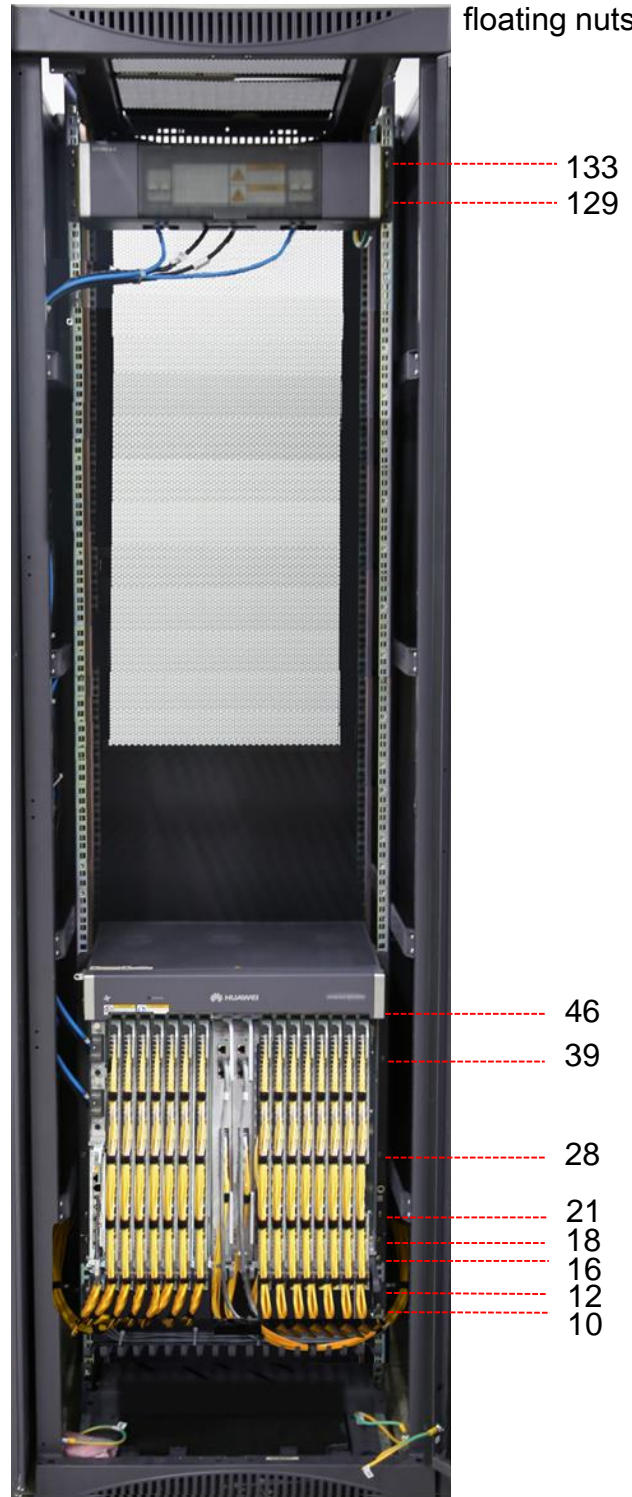

7.2 Routing the External Power Cables and PGND Cable

⚠ DANGER

- Shut off the DC input, and attach labels on the switches that will be set during the cabling work.
- Insulate the DC terminals and all unnecessary bare parts.
- If the lap resistance between PGND cable of the device and ground bar exceeds 0.1 ohm, route PGND cable again.

To office power supply

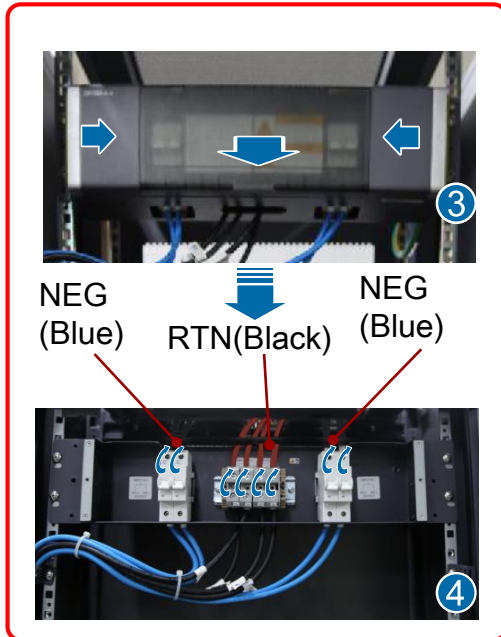
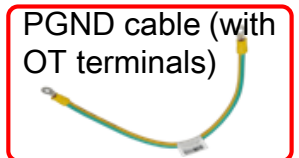
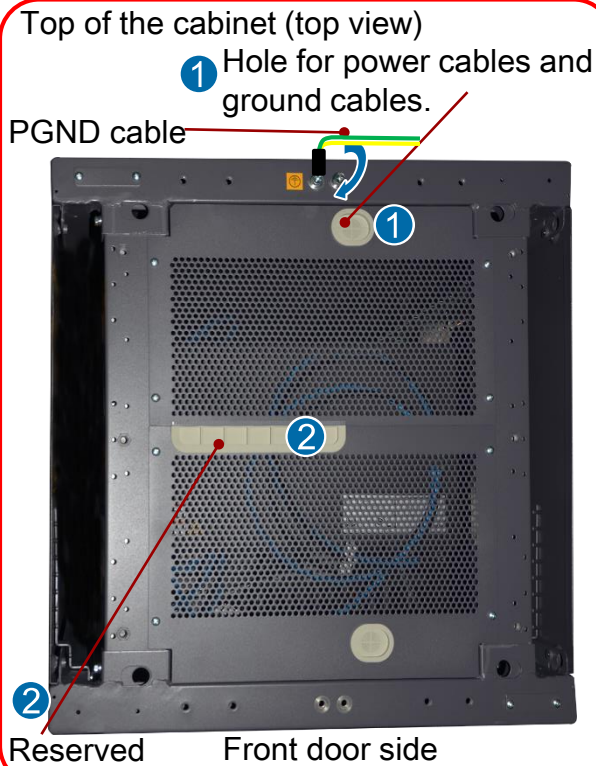

NOTE

- The four power inputs need to be controlled by independent circuit breakers when being connected to the DC PDU.
- The PDU requires four -48 V/-60 V power inputs and the rated current of one break circuit is at least 60 A.
- The image is for your reference only. The appearance of actual delivered PDB prevails.

7.3 Routing the Power Cables and PGND Cable of the Equipment

⚠ DANGER

- Shut off the DC input, and attach labels on the switches that will be set during the cabling work.
- Insulate the DC terminals and all unnecessary bare parts.
- If the lap resistance between PGND cable of the device and ground bar exceeds 0.1 ohm, route PGND cable again.

1 Connect the PGND cable

📖 NOTE

If the subrack is installed in a Huawei cabinet, it does not need to be separately grounded because the Huawei cabinet has been ground through mounting ears. However, it needs to be separately grounded if being installed in a third-party cabinet or rack that cannot be grounded through mounting ears. The ground point can be either of the following points.

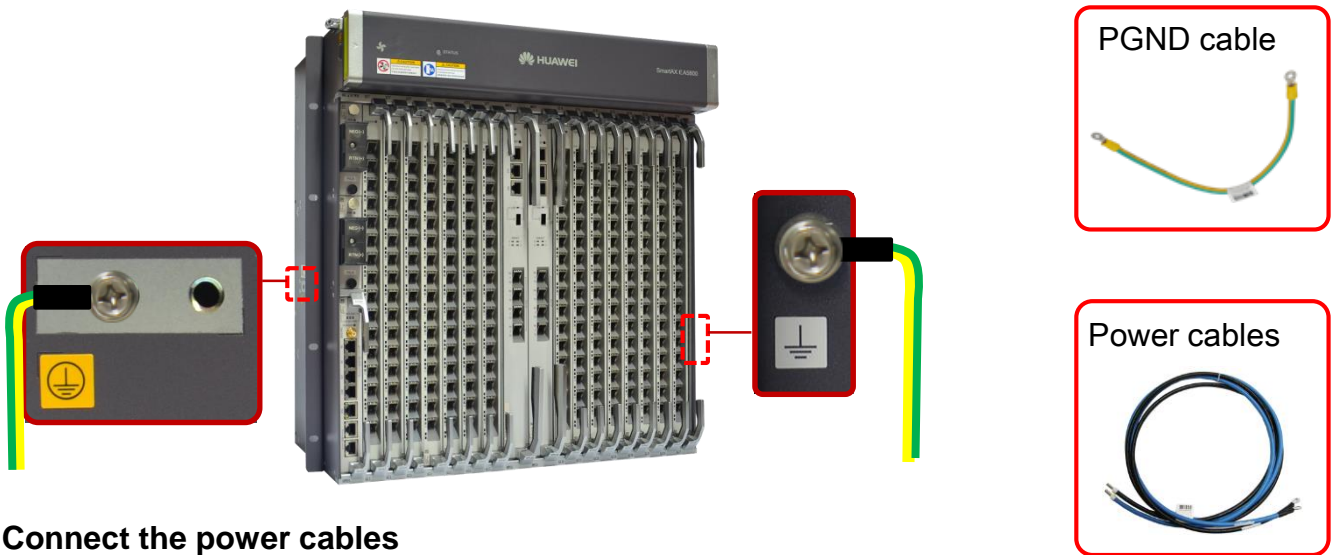

2 Connect the power cables

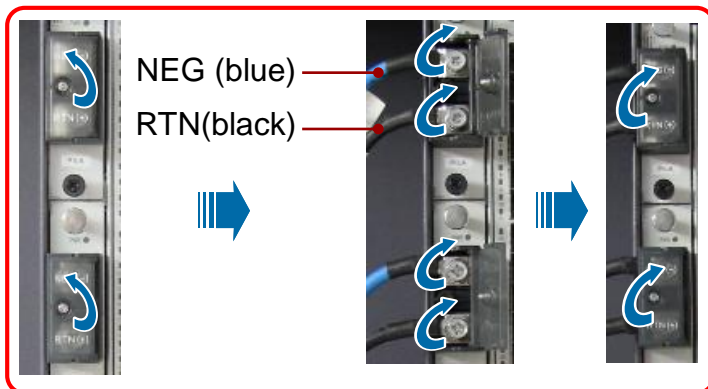

To the DC PDU

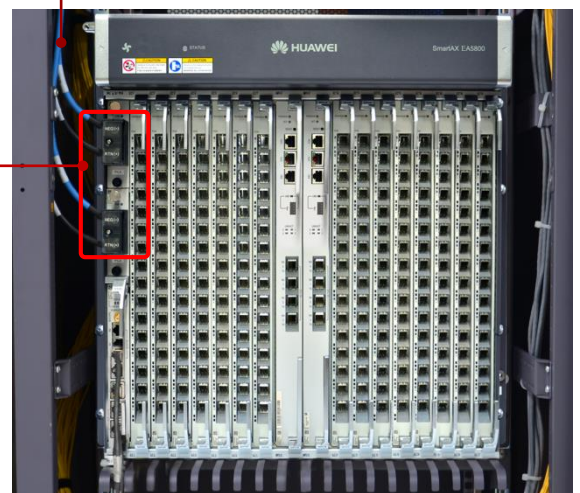

📖 NOTE

- The two power inputs need to be controlled by independent circuit breakers when being connected to the DC PDU.
- The PDU requires two -48 V/-60 V power inputs and the rated current of one break circuit is at least 60 A.

Phillips screwdriver





7 Routing Cables

7.4 Routing Clock Cables

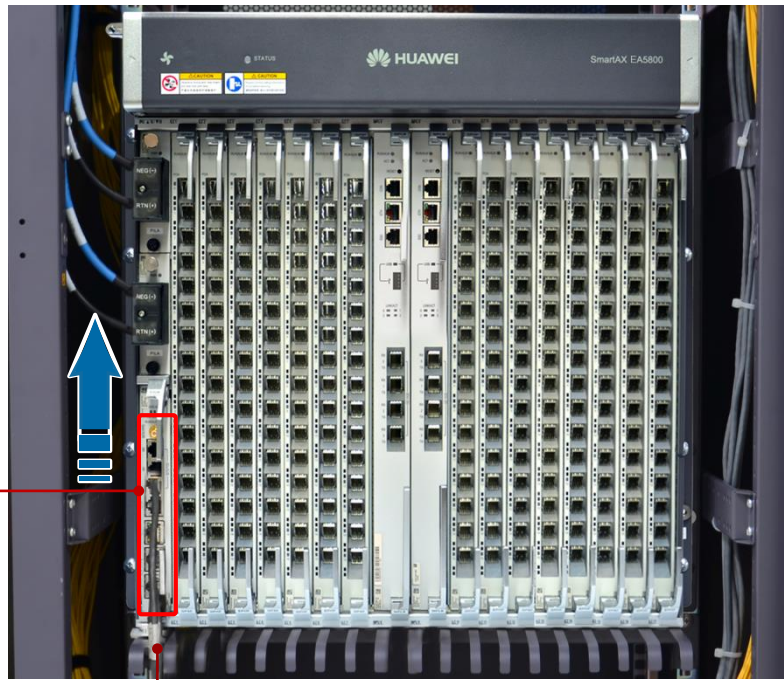
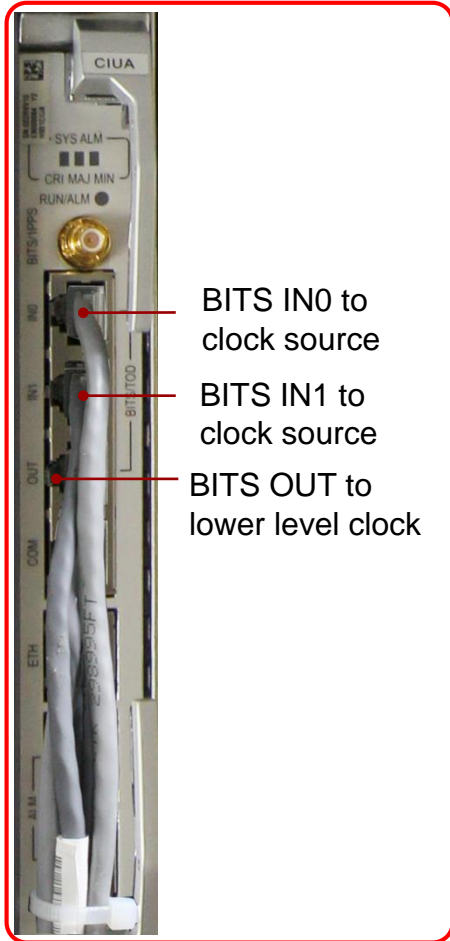

To the external clock device

Network cable





7 Routing Cables

7.5 Routing Network Cables

TO the maintenance terminal or transmission unit

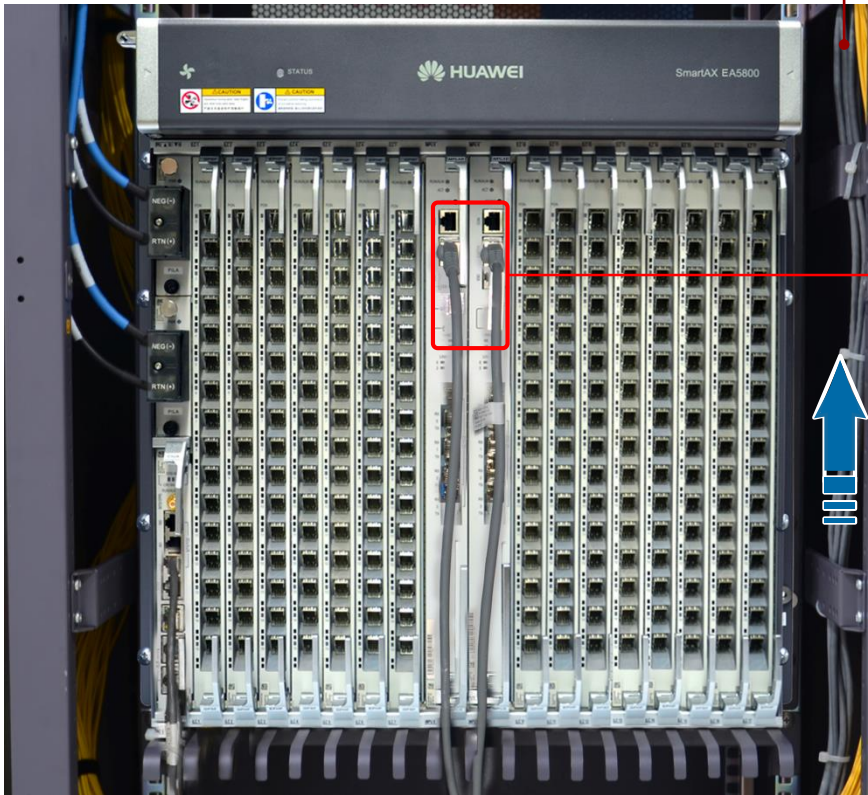

7.6 Routing Optical Fibers (Upstream)

DANGER

- When handling optical fibers, do not stand close to or look into the optical fiber outlet directly with naked eyes.
- Lead the optical fiber through a corrugated pipe. The mouth of the corrugated pipe must be wrapped with the adhesive tape. In the cabinet, the corrugated pipe should not be longer than 100 mm. In addition, the corrugated pipe is bound at the cabling aperture.
- The bending radius of the optical fiber should be more than 20 times the cable radius. In general, the bending radius of the optical fiber is more than or equal to 40 mm.

To ODF

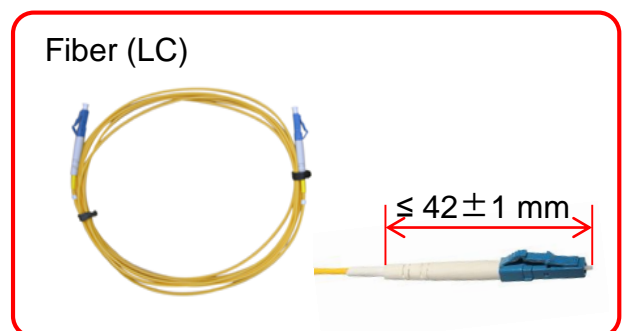
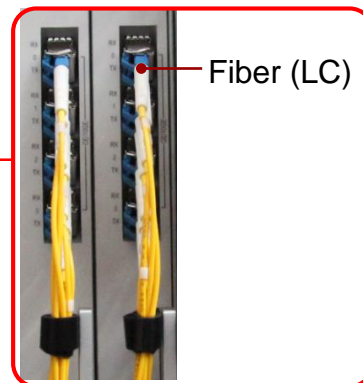
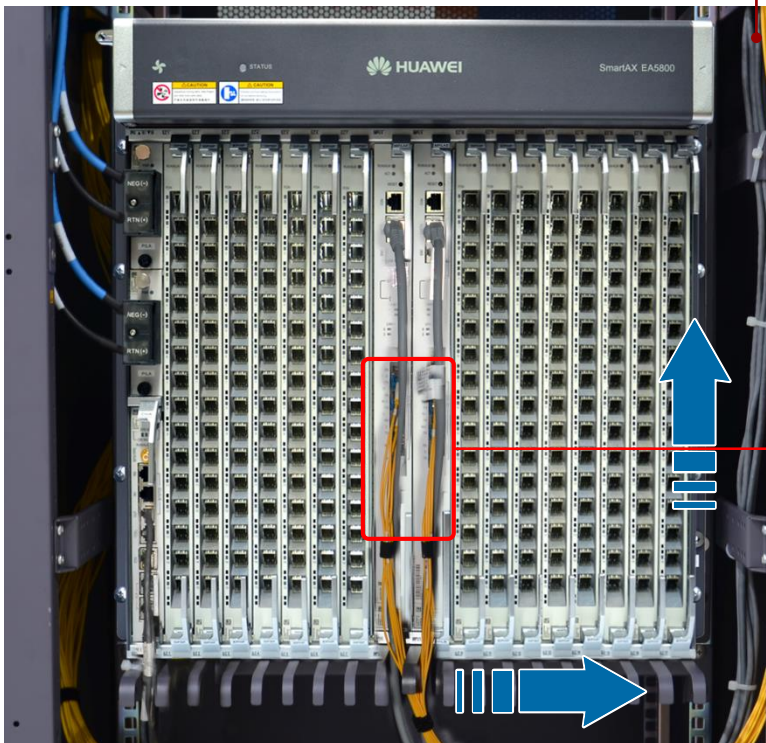

7.7 Routing Optical Fibers (P2P Board)

! DANGER

- When handling optical fibers, do not stand close to or look into the optical fiber outlet directly with naked eyes.
- Lead the optical fiber through a corrugated pipe. The mouth of the corrugated pipe must be wrapped with the adhesive tape. In the cabinet, the corrugated pipe should not be longer than 100 mm. In addition, the corrugated pipe is bound at the cabling aperture.
- The bending radius of the optical fiber routed on the 48-port P2P board is greater than or equal to 5 mm.
- The 48-port P2P board has 24 optical transceivers. 12 optical fibers for six optical transceivers are bundled in a group. When bundling the optical fiber, lean the optical fiber towards the right side of the board. Do not pile up the optical fibers on the board. This avoids oppression among optical fibers. Use four fiber binding straps at even distance to bundle the optical fibers of each board.

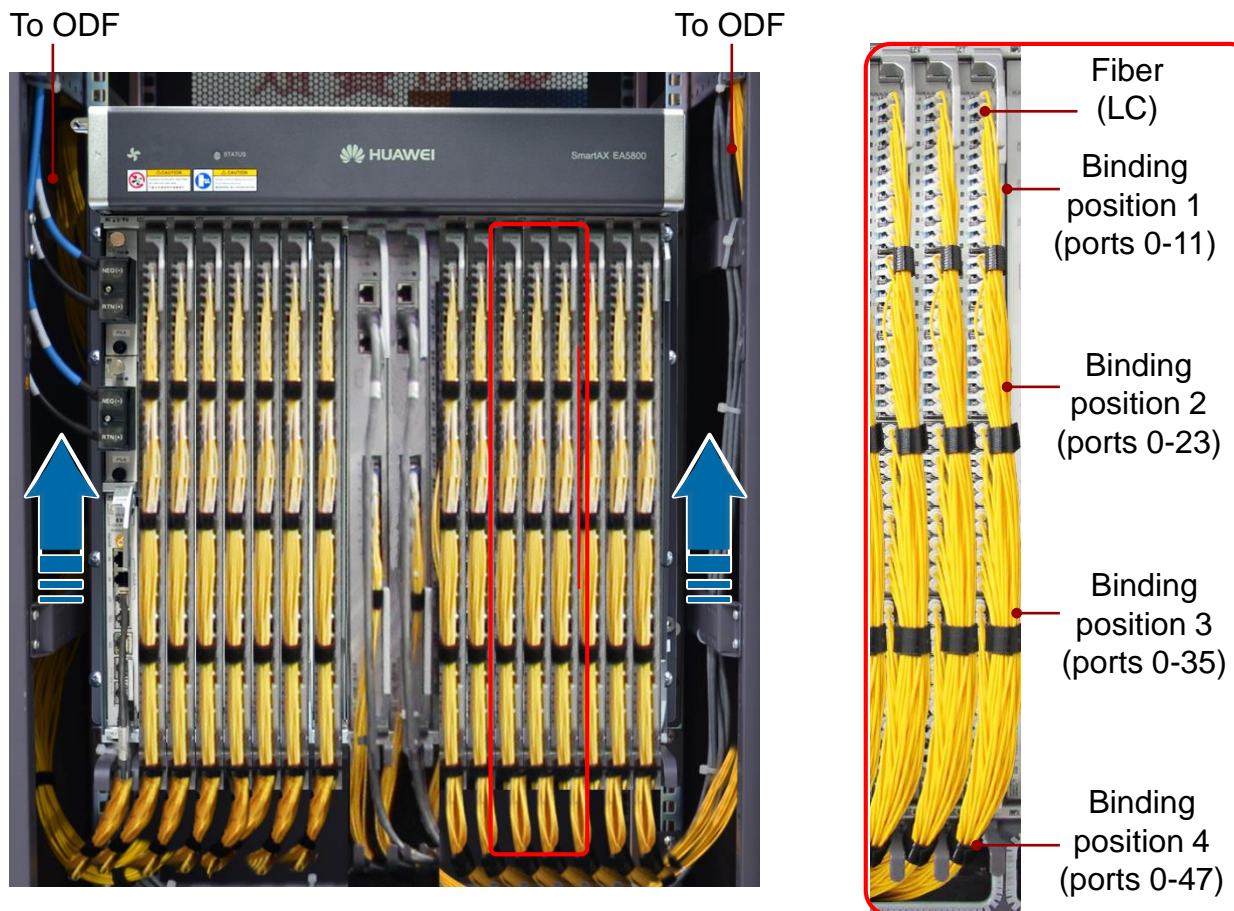

Fiber (LC)

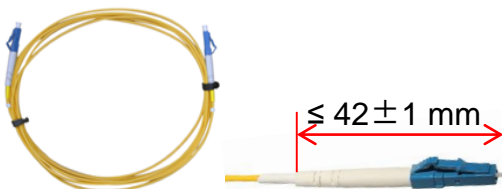

📖 NOTE

- When optical modules are preinstalled to boards before delivery, ensure that optical modules are properly installed before connecting fibers to boards.
- To facilitate the subsequent maintenance, bundle the newly routed optical fiber with the originally routed optical fiber firmly. Ensure that the height of the bundled optical fibers is lower than 55 mm.



7.8 Routing Optical Fibers (GPON Board)

NOTE

- When optical modules are preinstalled to boards before delivery, ensure that optical modules are properly installed before connecting fibers to boards.
- Route the fibers of the service boards on the left of the control board to the left side of the cabinet, and route the fibers of the service boards on the right of the control board to the right side of the cabinet.
- When the device uses the uplink interface board for upstream transmission of services, the optical fiber for the uplink interface board is routed in the same way as that for the control board.

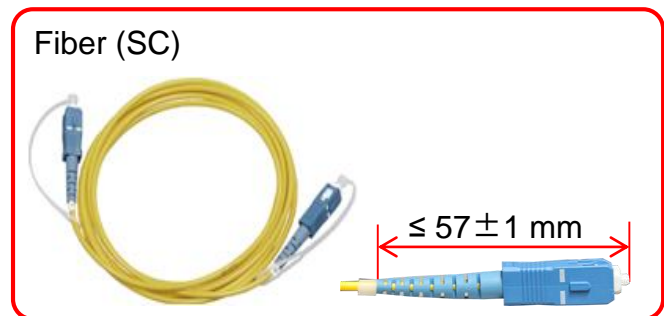
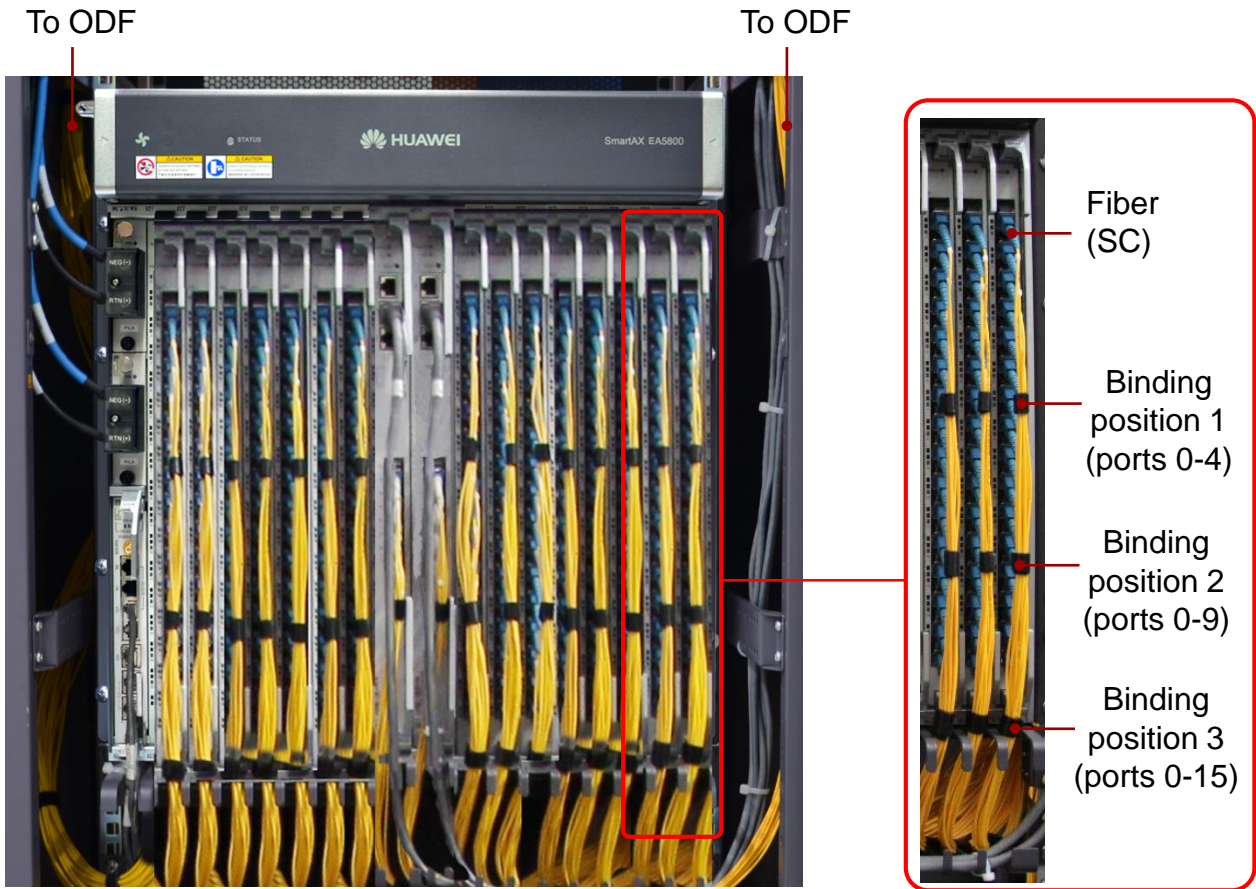



8 Post-Installation Check

No.	Description	Method
1	Do not place any materials on the chassis.	Observe
2	All vacant slots in a service subrack are filled in with filler panels.	Observe
3	All the cables are bound with proper tightness. The space between the cable ties is even, and the remaining parts of the cable ties are cut off neatly. All cable ties face the same direction, keeping the overall appearance nice.	Observe
4	The cross sectional area of the power cable and ground cable complies with the engineering design, and satisfy the requirements of equipment running.	Observe
5	The power cable and ground cable adopt a whole segment of copper core. The cable has no connection in the middle or scratch on the skin.	Observe
6	The power cables and ground cables must be routed horizontally and vertically without crossover. Proper margins must be reserved at the turning.	Observe
7	The power cables and ground cables must be connected correctly and reliably.	Observe
8	The identifiers on the power cable and ground cable must be correct, legible, and neat.	Observe
9	The power cables, ground cables, and signal cables must be routed separately.	Observe
10	Signal cables must be long enough, and must not be damaged or broken, without joint in the cable.	Observe
11	The connectors of the signal cables must be neat and intact. The connectors must be connected correctly and firmly. The tips must be connected securely.	Observe
12	Labels at both ends of the signal cables must be marked correctly, clearly and neatly.	Observe
13	If the fibers must be routed outside the cabinet, protection measures must be taken, such as using corrugated pipes or guide troughs.	Observe
14	Place the optical fiber pairs in order and bind them carefully with optical binders. No sharp edge is allowed.	Observe



9 Powering On the System

NOTE

Power on the device only when the input voltage is in the normal range.

- Use the multimeter to test the voltage between NEG(-) and RTN(+) on the DC PDU for the device powered by -48 V DC. The voltage should range from -38.4 V to -57.6 V.
- Use the multimeter to test the voltage between NEG(-) and RTN(+) on the DC PDU for the device powered by -60 V DC. The voltage should range from -48 V to -72 V.

- 1 Turn on the input power switches corresponding to the service subrack.
- 2 Check the status of fan tray.

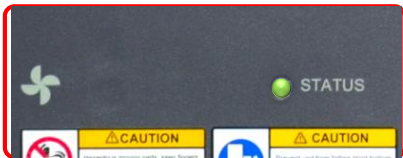

Normal status:
Green (On for 1s and off for 1s repeatedly)

