

DS-2DF8C442IXG1-ELW 4 MP 42 × Network IR Speed Dome



Hikvision 4 MP 42× Network IR Speed Dome adopts 1/1.8" progressive scan CMOS chip. With the 42 × optical zoom lens, the camera offers more details over expansive areas.

This series of cameras can be widely used for wide ranges of high-definition, such as the rivers, forests, roads, railways, airports, ports, squares, parks, scenic spots, stations and large venues, etc.

Hikvision has been dedicated to develop products with security since established.

Hikvision always follows security by design principle and has adopted many methods of security technologies into our product development lifecycle, including terminal security, data security, application security, network security, and privacy protection. In the meantime, the security technologies used by Hikvision are all in compliance with local applicable laws and safety regulations. These security measures could enhance product's cyber security protection capability and protect your devices as well as your data from malicious cyber attacks.

- 1/1.8" progressive scan CMOS
- High quality imaging with 4 MP resolution
- Excellent low-light performance via DarkFighter 2.0 technology
- Clear imaging against strong back light due to 150 dB AWDR technology
- 42× optical zoom and 16× digital zoom provide close up views over expansive areas
- Expansive night view with up to 400 m IR distance
- Water and dust resistant (IP67) and vandal resistant (IK10) excluding glass window
- Supports face capture to detect, capture, grade, and select faces in motion
- Supports road traffic to detect vehicles
- Smart Pan-Tilt Correction

▪ Specification

| Camera | |
|------------------------|------------------------------------------------------------------------------------------------------------------------------------------------------------------------------|
| Image Sensor | 1/1.8" progressive scan CMOS |
| Min. Illumination | Color: 0.001 Lux @ (F1.2, AGC ON), B/W: 0.0005 Lux @ (F1.2 , AGC ON), 0 Lux with IR |
| Shutter Speed | 1/1 s to 1/30,000 s |
| Slow Shutter | Yes |
| Day & Night | IR cut filter |
| Zoom | 42x optical, 16x digital |
| Max. Resolution | 2688 × 1520 |
| Lens | |
| Focus | Auto, semi-auto, manual, rapid focus |
| Focal Length | 6.0 mm to 252 mm |
| Zoom Speed | Approx. 4.5 s |
| FOV | Horizontal field of view: 56.6° to 1.7° (wide-tele), Vertical field of view: 33.7° to 0.9° (wide-tele), Diagonal field of view: 63.4° to 1.9° (wide-tele) |
| Aperture | Max. F1.2 |
| Illuminator | |
| Supplement Light Type | IR |
| Supplement Light Range | IR Distance: up to 400 m |
| Smart Supplement Light | Yes |
| PTZ | |
| Movement Range (Pan) | 360° , Smart Pan-Tilt Correction |
| Movement Range (Tilt) | -20° to 90° (auto flip) , Smart Pan-Tilt Correction |
| Pan Speed | Pan speed: configurable from 0.1° to 210°/s; preset speed: 280°/s |
| Tilt Speed | Tilt speed: configurable from 0.1° to 150°/s, preset speed 250°/s |
| Proportional Pan | Yes |
| Presets | 300 |
| Patrol Scan | 8 patrols, up to 32 presets for each patrol |
| Pattern Scan | 4 pattern scans, record time over 10 minutes for each scan |
| Power-off Memory | Yes |
| Park Action | Preset, pattern scan, patrol scan, auto scan, tilt scan, random scan, frame scan, panorama scan |
| 3D Positioning | Yes |
| PTZ Status Display | Yes |
| Preset Freezing | Yes |
| Scheduled Task | Preset, pattern scan, patrol scan, auto scan, tilt scan, random scan, frame scan, panorama scan, dome reboot, dome adjust, aux output |
| Video | |
| Main Stream | 50 Hz : 50 fps (2688 × 1520 , 2560 × 1440 , 1920 × 1080 , 1280 × 960 , 1280 × 720) 60 Hz : 60 fps (2688 × 1520 , 2560 × 1440 , 1920 × 1080 , 1280 × 960 , 1280 × 720) |
| Sub-Stream | 50 Hz: 25 fps (704 × 576, 640 × 480, 352 × 288) 60 Hz: 30 fps (704 × 480, 640 × 480, 352 × 240) |

| | |
|-----------------------------|-------------------------------------------------------------------------------------------------------------------------------------------------------------------------------------------------------------------------------------------------------------------------------------------------------------------------------------------------------------------------------------------------|
| Third Stream | 50 Hz : 25 fps (1920 × 1080 , 1280 × 960 , 1280 × 720 , 704 × 576 , 640 × 480 , 352 × 288) 60 Hz : 30 fps (1920 × 1080 , 1280 × 960 , 1280 × 720 , 704 × 480 , 640 × 480 , 352 × 240) |
| Video Compression | Main stream: H.265+/H.265/H.264+/H.264 Sub-stream: H.265/H.264/MJPEG Third stream: H.265/H.264/MJPEG |
| Video Bit Rate | 32 Kbps to 16384 Kbps |
| H.264 Type | Baseline Profile/Main Profile/High Profile |
| H.265 Type | Main Profile |
| Scalable Video Coding (SVC) | H.264 and H.265 encoding |
| Region of Interest (ROI) | 8 fixed regions for each stream |
| Target Cropping | No |
| Audio | |
| Audio Compression | G.711alaw, G.711ulaw, G.722.1, G.726, MP2L2, PCM |
| Audio Bit Rate | 64 Kbps (G.711)/16 Kbps (G.722.1)/16 Kbps (G.726)/32 to 192 Kbps (MP2L2) |
| Audio Sampling Rate | MP2L2: 16kHz, 32kHz, 48kHz,AAC-LC: 16kHz, 32kHz, 48kHz,PCM: 8kHz, 16kHz, 32kHz, 48kHz,MP3: 8kHz, 16KHz, 32KHz, 48KHz |
| Environment Noise Filtering | Yes |
| Network | |
| Smooth Streaming | Yes |
| Network Storage | NAS (NFS, SMB/ CIFS), ANR |
| Protocols | IPv4/IPv6, HTTP, HTTPS, 802.1x, Qos, FTP, SMTP, UPnP, SNMP, DNS, DDNS, NTP, RTSP, RTCP, RTP, TCP/IP, DHCP, PPPoE, UDP, IGMP, ICMP, Bonjour |
| API | ISUP, ISAPI, Hikvision SDK, Open Network Video Interface (Profile S, Profile G, Profile T, Profile M) , OTAP |
| Simultaneous Live View | Up to 20 channels |
| User/Host | Up to 32 users. 3 levels: Administrator, Operator and User |
| Security | Password protection,complicated password,HTTPS encryption,802.1X authentication (EAP-TLS, EAP-LEAP, EAP-MD5),watermark,IP address filter,basic and digest authentication for HTTP/HTTPS,WSSE and digest authentication for Open Network Video Interface, RTP/RTSP over HTTPS,control timeout settings,security audit log,TLS 1.3,host authentication (MAC address),TPM 2.0 (FIPS 140-2 level 2) |
| Client | HikCentral, iVMS-4200, Hik-Connect |
| Web Browser | IE11, Chrome 57.0+, Firefox 52.0+, Safari 11+ |
| Image | |
| Image Parameters Switch | Yes |
| Image Settings | Saturation, brightness, contrast, sharpness, gain, and white balance adjustable by client software or web browser |
| Wide Dynamic Range (WDR) | 150 dB |
| Day/Night Switch | Day, night, auto, scheduled-switch |
| Image Enhancement | BLC, HLC, 3D DNR |
| Defog | Optical defog |
| Image Stabilization | Yes. Built-in gyroscope to improve EIS performance. |

| | |
|-------------------------------|------------------------------------------------------------------------------------------------------------------------------------------------------------------------------------------------------------------------------------------------------------|
| Regional Exposure | Yes |
| Regional Focus | Yes |
| Privacy Mask | Up to 24 masks, polygon region, mosaic mask, mask color configurable |
| SNR | ≥ 52 dB |
| Supplement Detection | |
| Gyroscope | Yes |
| Satellite Positioning | No |
| Compass | No |
| Interface | |
| Reset | Yes |
| Ethernet Interface | 1 RJ45 10M/100M self-adaptive Ethernet port |
| On-board Storage | Built-in memory card slot, support MicroSD/MicroSDHC/MicroSDXC, up to 256 GB |
| Alarm | 7 inputs, 2 outputs |
| Audio | 1 input (line in), max. input amplitude: 2-2.4 vpp, input impedance: 1 KΩ ± 10%; 1 output (line out), line level, output impedance: 600 Ω |
| Video Output | 1.0V[p-p]/75Ω, PAL, NTSC, BNC connector |
| RS-485 | Half duplex, HIKVISION, Pelco-P, Pelco-D, self-adaptive |
| Event | |
| Basic Event | Motion detection,video tampering alarm,exception (network disconnected, IP address conflict, illegal login, HDD full, HDD error),alarm input and output,vandal-proof alam,audio exception detection,unattended baggage detection, object removal detection |
| Linkage | Upload to FTP/NAS/memory card,notify surveillance center,send email,trigger recording,and PTZ actions (such as preset, patrol scan, pattern scan) |
| Deep Learning Function | |
| Perimeter Protection | Line crossing detection, region entrance detection, intrusion detection, region exiting detection |
| Multi-Target-Type Detection | Supports simultaneous detection and capture of human body, face and vehicle, Gets 7 face features, 14 human body features and 8 vehicle features |
| Face Capture | Detects up to 30 faces simultaneously, Uploads face with background and closed-up face pictures,Supports detecting, tracking, capturing, grading, selecting of face in motion, and outputs the best face picture |
| Face Comparison | Up to 10 face libraries. 30000 faces for each library. 150000 faces in total, Recognizes face identity via face modeling, grading and comparing to those in face library, Supports face library encryption |

| | |
|------------------------------------|-----------------------------------------------------------------------------------------------------------------------------------------------------------------------------------------------------------------------------------------------------------------------------------------------------------------------------------------------------------------------------------------------------------------------------------------------------------------------------------------------------------------------------------------------------------------------------------------------------------------------------------------------------------------------------------------------------------------------------------------------------------------------------------------------------------------------------------------------------------------------------------------------------------------------------------------|
| Road Traffic and Vehicle Detection | <p>Smart Function:</p> <p>Support license plate recognition of vehicles and motorcycles (only in checkpoint scenario)</p> <p>Support vehicle attribute detection, including vehicle type, color, brand, driving direction, etc.</p> <p>Support vehicle and non-vehicle counting</p> <p>Blocklist and allowlist: up to 10,000 records</p> <p>LPR Countries/Regions:</p> <p>4 areas (Europe, Middle East, Asia-Pacific, Africa) and more than 124 countries/regions</p> <p>Accuracy (Under recommended installation and lighting conditions):</p> <p>License plate recognition rate $\geq 98\%$</p> <p>Capture rate $\geq 99\%$</p> <p>Driving direction accuracy rate $\geq 98\%$</p> <p>Vehicle Capture Speed:</p> <p>Front installation in checkpoint scenario: up to 120 km/h</p> <p>Side installation: up to 80 km/h</p> <p>Capture Mode: License Plate and Vehicle Mode, Vehicle Priority Mode</p> |
| Linkage and Tracking | |
| Smart Tracking | Manual tracking, auto-tracking 3.0 |
| Object Tracking | Support person arming. When the device detects the armed face or human body in the monitoring scene, it triggers alarms, and tracks and captures the target. During the tracking, the target location and other related information are uploaded. |
| General | |
| Vandal-proof Alarm | No |
| Heater | Yes |
| Wiper | Yes. Rain-sensing auto control |
| De-icing | No |
| Demist | Yes |
| General Function | Mirror, password protection, watermark, IP address filter |
| Power | 36 VDC (Max. 62 W, including max. 12 W for IR and max. 8 W for heater), PoE 802.3 bt (Max. 51 W, including max. 12 W for IR and max. 8 W for heater) |
| Operating Condition | Temperature: -40°C to 70°C (-40°F to 158°F), Humidity: $\leq 95\%$ |
| Dimension | $\varnothing 267\text{ mm} \times 430\text{ mm}$ ($\varnothing 10.51" \times 16.93"$) |
| Weight | Approx. 9.6 kg (21.16 lb.) |
| Language | 33 languages: English, Russian, Estonian, Bulgarian, Hungarian, Greek, German, Italian, Czech, Slovak, French, Polish, Dutch, Portuguese, Spanish, Romanian, Danish, Swedish, Norwegian, Finnish, Croatian, Slovenian, Serbian, Turkish, Korean, Traditional Chinese, Thai, Vietnamese, Japanese, Latvian, Lithuanian, Portuguese (Brazil), Ukrainian |
| Approval | |
| EMC | <p>CE-EMC (EN 55032: 2015, EN 61000-3-2: 2019, EN 61000-3-3: 2013, EN 50130-4: 2011 +A1: 2014);</p> <p>RCM (AS/NZS CISPR 32: 2015);</p> <p>IC VoC (ICES-003: Issue 6, 2019);</p> <p>KC (KN 32: 2015, KN 35: 2015)</p> |

| | |
|---------------------------|-------------------------------------------------------------------------------------------------------------------------------------------|
| Safety | CB (IEC 62368-1:2014+A11); CE-LVD (EN 62368-1:2014+A11:2017), BIS (IS 13252(Part 1):2010+A1:2013+A2:2015); LOA (SANS IEC60950-1) |
| Environment | CE-RoHS (2011/65/EU); WEEE (2012/19/EU); Reach (Regulation (EC) No 1907/2006) |
| Anti-Corrosion Protection | No |
| Protection | IP67 (IEC 60529-2013), IK10 (IEC 62262:2002), 6000V Lightning Protection, Surge Protection and Voltage Transient Protection |

▪ DORI

The DORI (detect, observe, recognize, identify) distance gives the general idea of the camera ability to distinguish persons or objects within its field of view.

It is calculated based on the camera sensor specification and the criteria given by EN 62676-4: 2015.

| DORI | Detect | Observe | Recognize | Identify |
|-----------------|-----------------------|----------------------|---------------------|---------------------|
| Definition | 25 px/m | 63 px/m | 125 px/m | 250 px/m |
| Distance (Tele) | 3475.9 m(11403.87 ft) | 1379.3 m(4525.26 ft) | 695.2 m(2280.84 ft) | 347.6 m(1149.42 ft) |

▪ Typical Application

Hikvision products are classified into three levels according to their anti-corrosion performance. Refer to the following description to choose for your using environment.

DS-2DF8C442IXG1-EL and DS-2DF8C442IXG1-ELW have NO SPECIFIC PROTECTION.

DS-2DF8C442IXG1-ELY and DS-2DF8C442IXG1-ELWY have MODERATE PROTECTION.

| Level | Description |
|------------------------|--------------------------------------------------------------------------------------------------------------------------------------------------------------------------------------------------------------------------------------------------------|
| Top-level protection | Hikvision products at this level are equipped for use in areas where professional anti-corrosion protection is a must. Typical application scenarios include coastlines, docks, chemical plants, and more. |
| Moderate protection | Hikvision products at this level are equipped for use in areas with moderate anti-corrosion demands. Typical application scenarios include coastal areas about 2 kilometers (1.24 miles) away from coastlines, as well as areas affected by acid rain. |
| No specific protection | Hikvision products at this level are equipped for use in areas where no specific anti-corrosion protection is needed. |

▪ Available Model

DS-2DF8C442IXG1-ELW



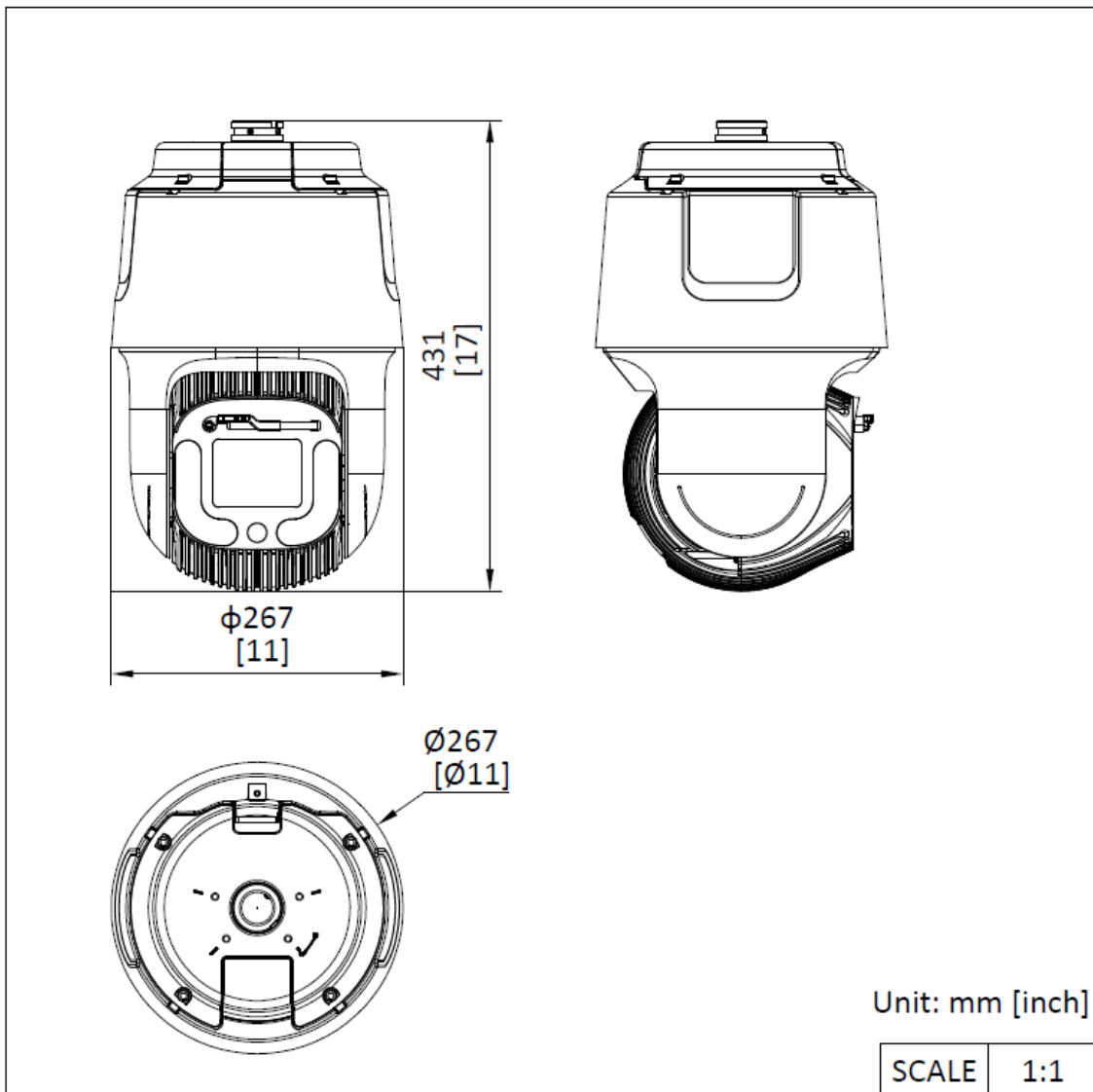





▪ **Dimension**



▪ **Accessory**

▪ **Optional**

| | | | | |
|---------------------|---------------------|--------------------|---------------------|---------------------|
| DS-1673ZJ-P | DS-1684ZJ-P | DS-1674ZJ-P | DS-4650ZJ-PC | DS-4660ZJ-PC |
| Vertical pole mount | Vertical pole mount | Junction box | Vertical pole mount | Corner mount |

| | | | | |
|-------------------------------------------------------------------------------------------------------------|-------------------------------------------------------------------------------------|-----------------------------------------------------------------------------------|-------------------------------------------------------------------------------------|-------------------------------------------------------------------------------------|
|  |  |  |  |  |
|  |  | | | |
| <p>DS-4603ZJ-PA Wall Mount Bracket In/Outdoor for PTZ Camera</p> | | <p>DS-4612ZJ-PA Pendant Mount</p> | | |
|  |  | | | |
| | | | | |

Headquarters

No.555 Qianmo Road, Binjiang District,
Hangzhou 310051, China
T +86-571-8807-5998
www.hikvision.com



Follow us on social media to get the latest product and solution information.

