



Installation and configuration manual With hoymiles

Pytes Lithium Battery V5° series

With hoymiles Inverter HYS-(3-6)LV-EUG1, HAS-(3-5)LV-EUG1



CONTENTS

BOM LIST 3

1. Power Cable Connection..... 6

 Step.1 6

 Step.2..... 6

2. Communication Cable Connection 7

3. Set The DIP Switch..... 8

4. Start up the system 8

5.Change the battery setting of the inverter 9

6.System monitoring 11

BOM LIST

Before installation, you should prepare following items.

Item	Remarks	Quantity
Power Cable (DC)	<ul style="list-style-type: none"> <input type="checkbox"/> Conductor cross-section: 50 mm² to 95 mm² <input type="checkbox"/> Cable diameters: 14 mm to 25 mm <input type="checkbox"/> Only copper cables may be used. <input type="checkbox"/> The DC cables must be sized for the maximum battery voltage and the maximum battery current (see battery manufacturer documentation). 	Depends on the number of batteries and the connection method
Com. Cable	CAN communication or RS485 communication	1
Battery	V5° series	Depends on the number of batteries and the connection method
Inverter	Hoymiles	1

Notice:

1. Definition of RJ45 Port Pin for BMS is as follow.

The version of V5°.

V5°



V5°alpha



CAN port definition

Version of V5°	Pin number of com. cable
V5° & V5°a	

2. We have already listed by hoymiles. But please confirm that the ARM version of inverter is 0.2.18 or above. If not, please updating it before setup the whole system.

Link: [Hoymiles-Compatible-Battery-List_V1.41.pdf](#)

HOW TO INSATLL

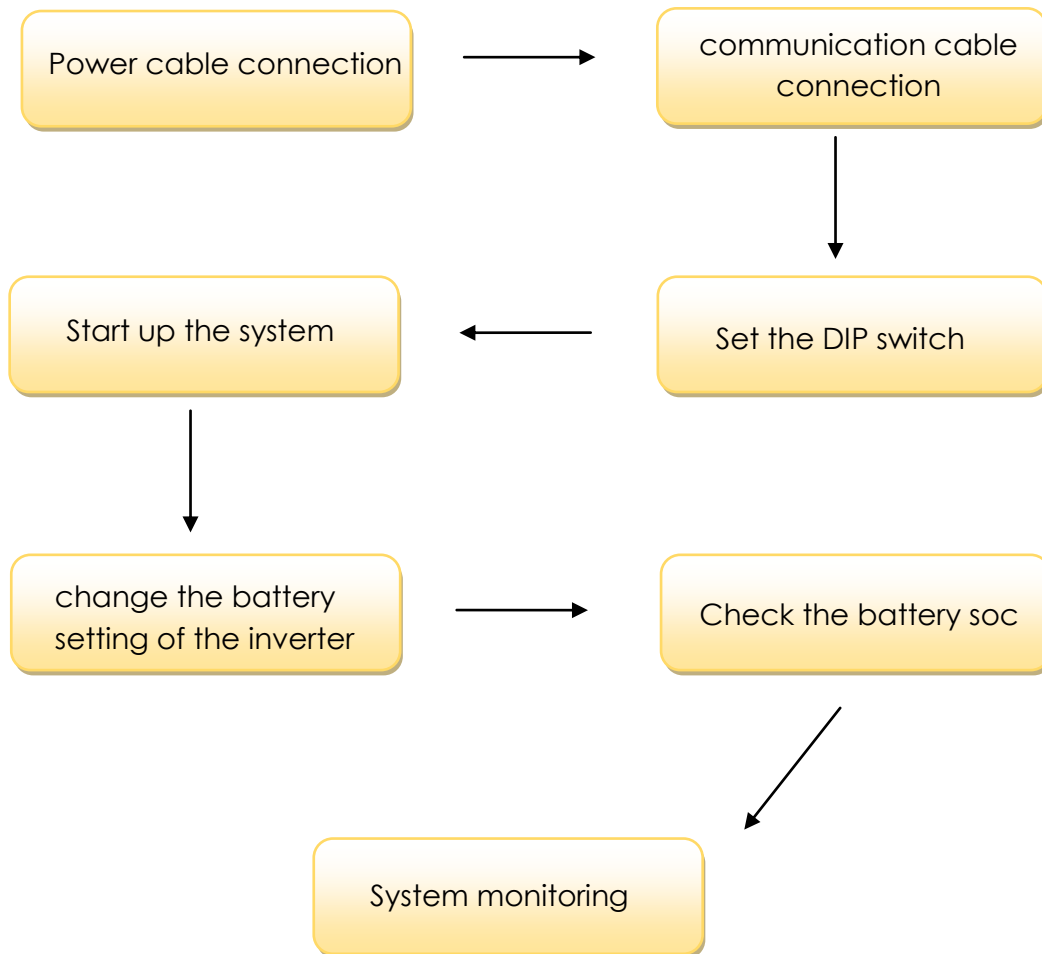

CAUTION: If you want to get more inverter-related settings, please refer to the inverter user manual first.

1. Power Cable Connection

Step.1

Connect the red and black cables to the inverter DC connector as shown in Pic 1.1.1.

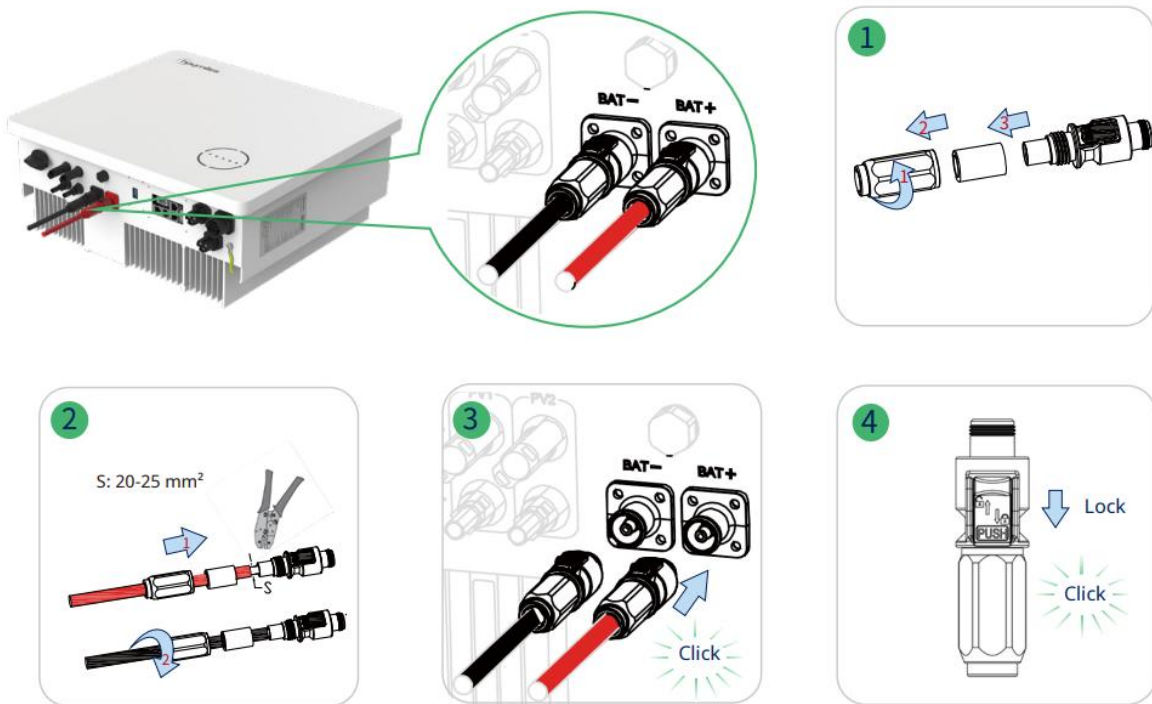

Pic 1.1.1

 <p>NOTICE</p>	<ul style="list-style-type: none">• Use the battery connectors in the accessory box for battery connections.
---	--

Step.2

At the other end of the cable, connect to the battery as shown Pic 1.1.2. (Ensure that the battery power switch is off)

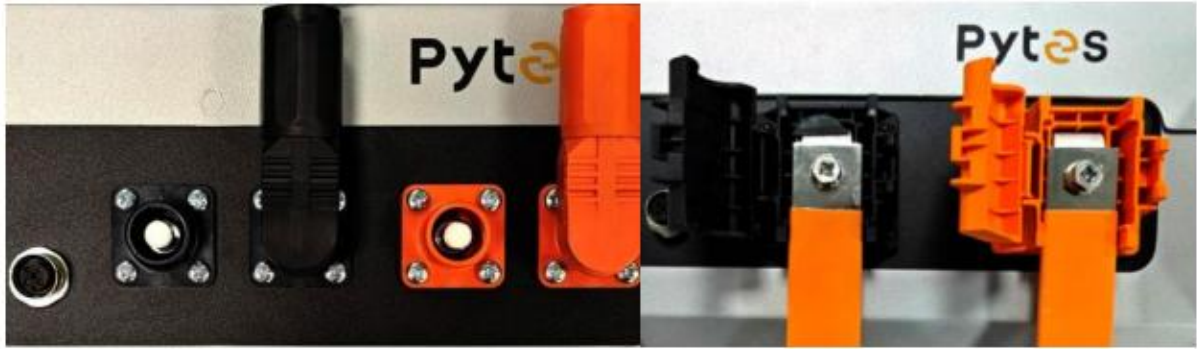



Pic 1.1.2

2. Communication Cable Connection

Connect the end of the cable to the inverter communication port as shown in pic 1.2.1. Make sure which communication port to use.

DI	DRM			 Para1	8-485A_2	120 Ohm	
2	4	6	8		7-485B_2	ON	OFF
IN-	D2/6	D4/8	REF		6-485A_1		
1	3	5	7	5-485B_1	4-CANL	DO1	
IN+	D1/5	D3/7	COM	3-CANH	2-DI IN-	1	2
				2-DI IN+	1-DI IN+	NO1	COM1
						DO2	
						1	2
						NO2	COM2

 Meter	8-NC 7-NC 6-NC 5-485B 4-485A 3-NC 2-NC 1-NC	 BMS	8-485B 7-485A 6-NC 5-CANL 4-CANH 3-NTC- 2-NC 1-NTC+	 Para2	8-485A_2 7-485B_2 6-485A_1 5-485B_1 4-CANL 3-CANH 2-DI IN- 1-DI IN+
--	--	--	--	--	--

Pic 1.2.1

Connect the other end of the cable to the battery communication port as shown in pic 1.2.2. (Ensure the correct sequence of communication cable)



Pic 1.2.2

3. Set the DIP Switch

Set the DIP switch as shown in Pic 1.3.1.

Version of V5°	ADD setting
V5° & V5°a	<div style="display: flex; align-items: center;"> <div style="border: 1px solid black; padding: 5px; margin-right: 10px;">Hoymiles</div> </div>

Pic 1.3.1

4. Start up the system

Once the unit has been properly installed and the batteries are connected well, turn on the batteries, then turn on the Battery Breaker (if have), Grid Breaker, Backup Breaker and Main breaker

to power the system.

5. Change the battery setting of the inverter

※CAUTION:If you want more details about the batteries settings, please check the operating manual of inverters.

Log in with your account and password on S-MILES Cloud.

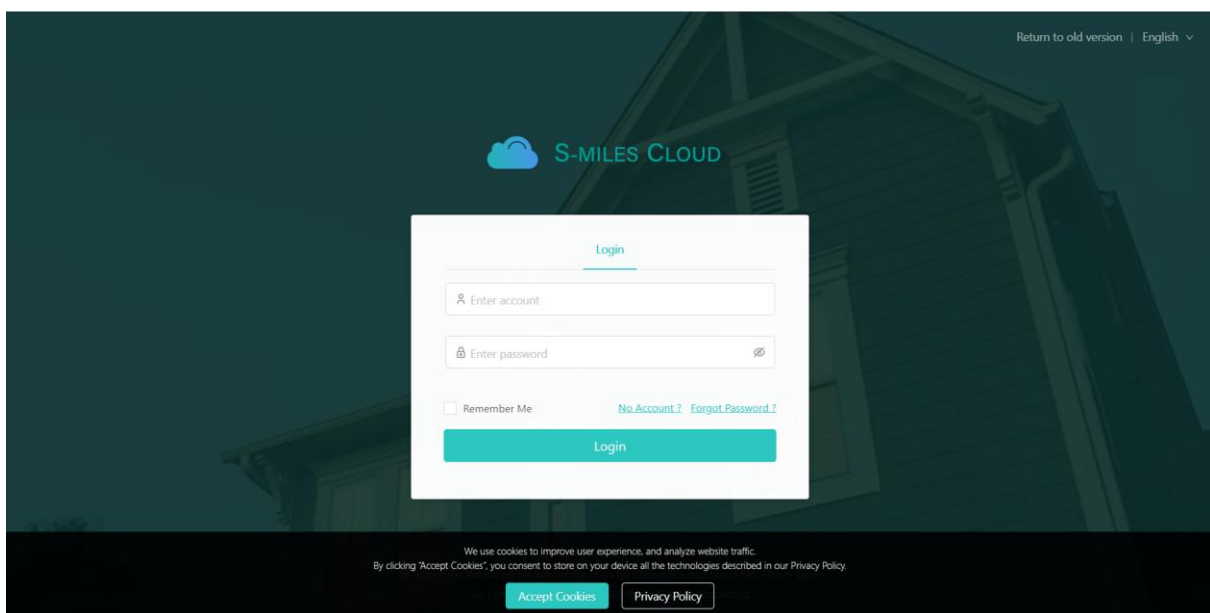

Pic 2.2.1

Select Li-ion Battery and PYTES BMS protocol.

S-MILES CLOUD Home

Plant / Devices

Dashboard Devices

All Devices Enter SN

SN

430122480938

200422440850

000100001810

Device Maintenance

Inverter SN:

Plant:

Software Ver. (System):

Software Ver. (Safety):

Device Maintenance:

Select Battery Type

Name	Value	Unit	Range
Battery Config	Li-ion Battery	-	-
BMS Protocol	PYTES	-	-
Battery Capacity	100	Ah	0-1000

Cancel Confirm

Pic 2.2.2

6. System monitoring

※**CAUTION:** If you want more details about system monitoring, please check the operating manual of inverters.

Please download the S-Miles Cloud App from the Google Play Store or the Apple App Store. The QR code below can also be scanned to download the App. **Please refer to the S-Miles Cloud User Manual from www.hoymiles.com/resources/download/ for details.**

Download the app from the app store.



S-Miles Installer



S-Miles End-user

Pic 3.2.1

-END-