

AX-E200S0T0

Fail Safe Electric Bolt W/Signal Time, Open Wire

Parameters

Face Plate	205Lx35Wx41H(mm)
Magnetic Plate	90Lx25Wx2H(mm)
Decorative Panel	215Lx40Wx0.5H(mm)
Bolt	16mmDIA, stainless steel 16mm throw
Signal Output	NC/COM

Time Delay	0 / 3 / 6 / 9 s e c
Voltage	1 2 - 2 4 V D C
Current	12V/900mA 12V/120mA; 24V/730mA 24V/80mA
Fail Safe	Locked when energized
Weight	0 . 7 k g

Dimensions

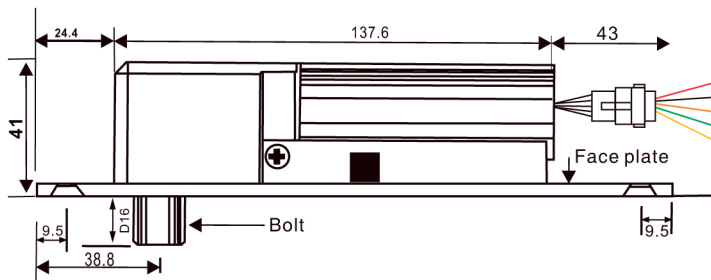

Red	+
Black	-
Orange	OPEN
Green	COM
Yellow	NC

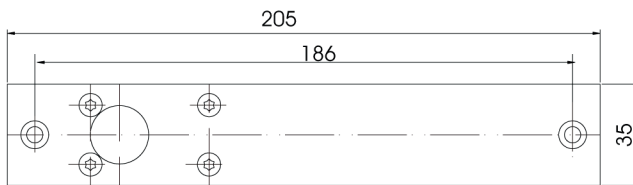

Face plate

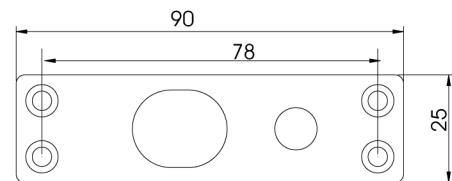

Magnetic Plate

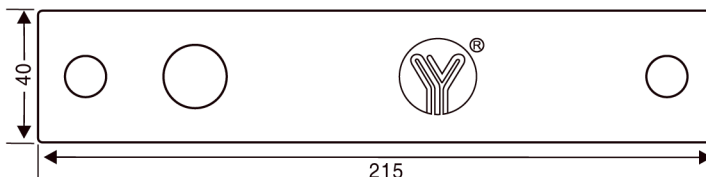

Decorative Plate

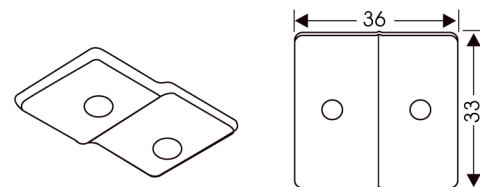

Extended Plate

► Installation

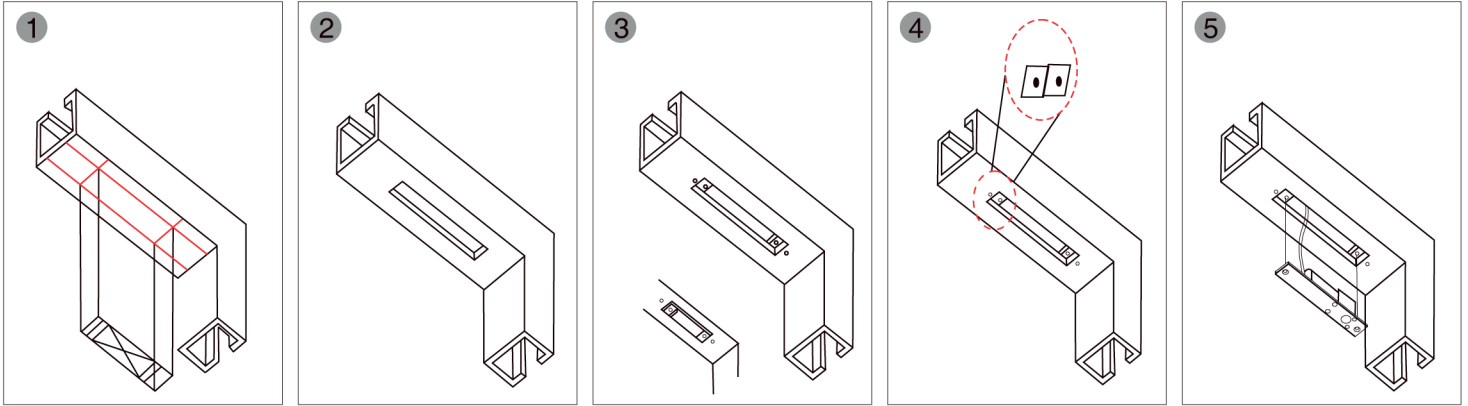

1 Place lock body template to match with door frame center line

2 Cut hole

3 Fix mounting plate (For hollow metal frame)

4 Connect wires

5 Mount lock body on the door frame and test

► Installation Instruction

Frameless Glass Door

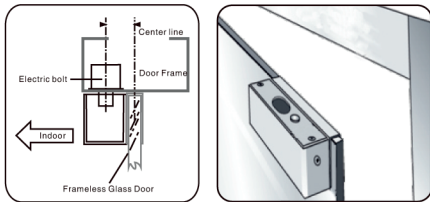

Fully Frameless Glass Door

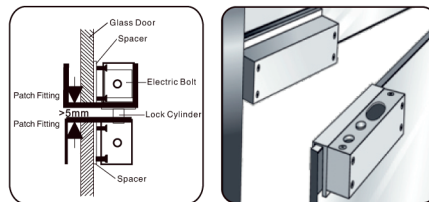

Aluminium Bracket for Narrow Door

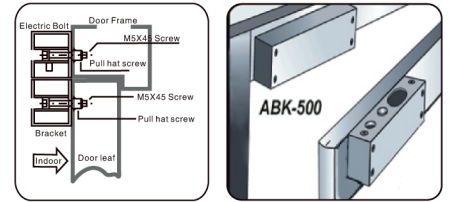

► Wiring Diagram

