



RF DIRECTIONAL
THRULINE® WATTMETER
MODEL 43

ALSO COVERS MODELS 443 I , 43P
AND SERIES 4300 AND 4520

OPERATION MANUAL

©COPYRIGHT 2016 BY BIRD TECHNOLOGIES, INC.
INSTRUCTION BOOK PART NUMBER 920-43 REV. L

THRULINE® AND TERMLINE® ARE REGISTERED TRADEMARKS
OF BIRD ELECTRONIC CORPORATION

Safety Precautions

The following are general safety precautions that are not necessarily related to any specific part or procedure, and do not necessarily appear elsewhere in this publication. These precautions must be thoroughly understood and apply to all phases of operation and maintenance.

WARNING

Keep Away From Live Circuits

Operating Personnel must at all times observe general safety precautions. Do not replace components or make adjustments to the inside of the test equipment with the high voltage supply turned on. To avoid casualties, always remove power.

WARNING

Shock Hazard

Do not attempt to remove the RF transmission line while RF power is present.

WARNING

Do Not Service Or Adjust Alone

Under no circumstances should any person reach into an enclosure for the purpose of service or adjustment of equipment except in the presence of someone who is capable of rendering aid.

WARNING

Safety Earth Ground

An uninterruptible earth safety ground must be supplied from the main power source to test instruments. Grounding one conductor of a two conductor power cable is not sufficient protection. Serious injury or death can occur if this grounding is not properly supplied.

WARNING

Resuscitation

Personnel working with or near high voltages should be familiar with modern methods of resuscitation.

WARNING

Remove Power

Observe general safety precautions. Do not open the instrument with the power on.

Safety Symbols

WARNING

Warning notes call attention to a procedure, which if not correctly performed, could result in personal injury.

CAUTION

Caution notes call attention to a procedure, which if not correctly performed, could result in damage to the instrument.



The caution symbol appears on the equipment indicating there is important information in the instruction manual regarding that particular area.

Note: *Calls attention to supplemental information.*

Warning Statements

The following safety warnings appear in the text where there is danger to operating and maintenance personnel, and are repeated here for emphasis.

WARNING

Leaking RF energy is a potential health hazard. Never attempt to connect or disconnect equipment from the transmission line while RF power is being applied. Severe burns, electrical shock, or death can occur.

On page 11.

WARNING

When working with RF powers of 200 watts or more, the potential of the center conductor of the line section will be over 100 volts. Do not touch the center conductor while RF power is on.

On page 12.

Caution Statements

The following equipment cautions appear in the text and are repeated here for emphasis.

CAUTION

For low reflection measurements, do not rotate the reflected power element to read forward power. Damage to the element or wattmeter could result.

On page 7.

CAUTION

Handle elements with care. Calibration could be disturbed if they are dropped.

On page 11.

CAUTION

Do not attempt to remove the RF center conductor. This will damage the line section.

On page 19.

Safety Statements

USAGE

ANY USE OF THIS INSTRUMENT IN A MANNER NOT SPECIFIED BY THE MANUFACTURER MAY IMPAIR THE INSTRUMENT'S SAFETY PROTECTION.

USO

EL USO DE ESTE INSTRUMENTO DE MANERA NO ESPECIFICADA POR EL FABRICANTE, PUEDE ANULAR LA PROTECCIÓN DE SEGURIDAD DEL INSTRUMENTO.

BENUTZUNG

WIRD DAS GERÄT AUF ANDERE WEISE VERWENDET ALS VOM HERSTELLER BESCHRIEBEN, KANN DIE GERÄTESICHERHEIT BEEINTRÄCHTIGT WERDEN.

UTILISATION

TOUTE UTILISATION DE CET INSTRUMENT QUI N'EST PAS EXPLICITEMENT PRÉVUE PAR LE FABRICANT PEUT ENDOMMAGER LE DISPOSITIF DE PROTECTION DE L'INSTRUMENT.

IMPIEGO

QUALORA QUESTO STRUMENTO VENISSE UTILIZZATO IN MODO DIVERSO DA COME SPECIFICATO DAL PRODUTTORE LA PROZIONE DI SICUREZZA POTREBBE VENIRNE COMPROMESSA.

SERVICE

SERVICING INSTRUCTIONS ARE FOR USE BY SERVICE - TRAINED PERSONNEL ONLY. TO AVOID DANGEROUS ELECTRIC SHOCK, DO NOT PERFORM ANY SERVICING UNLESS QUALIFIED TO DO SO.

SERVICIO

LAS INSTRUCCIONES DE SERVICIO SON PARA USO EXCLUSIVO DEL PERSONAL DE SERVICIO CAPACITADO. PARA EVITAR EL PELIGRO DE DESCARGAS ELÉCTRICAS, NO REALICE NINGÚN SERVICIO A MENOS QUE ESTÉ CAPACITADO PARA HACERLO.

WARTUNG

ANWEISUNGEN FÜR DIE WARTUNG DES GERÄTES GELTEN NUR FÜR GESCHULTES FACHPERSONAL. ZUR VERMEIDUNG GEFÄHRLICHE, ELEKTRISCHE SCHOCKS, SIND WARTUNGSARBEITEN AUSSCHLIEßLICH VON QUALIFIZIERTEM SERVICEPERSONAL DURCHZUFÜHREN.

ENTRETIEN

L'EMPLOI DES INSTRUCTIONS D'ENTRETIEN DOIT ÊTRE RÉSERVÉ AU PERSONNEL FORMÉ AUX OPÉRATIONS D'ENTRETIEN. POUR PRÉVENIR UN CHOC ÉLECTRIQUE DANGEREUX, NE PAS EFFECTUER D'ENTRETIEN SI L'ON N'A PAS ÉTÉ QUALIFIÉ POUR CE FAIRE.

ASSISTENZA TECNICA

LE ISTRUZIONI RELATIVE ALL'ASSISTENZA SONO PREVISTE ESCLUSIVAMENTE PER IL PERSONALE OPPORTUNAMENTE ADDESTRATO. PER EVITARE PERICOLOSE SCOSSE ELETTRICHE NON EFFETTUARE ALCUNA RIPARAZIONE A MENO CHE QUALIFICATI A FARLA.

RF VOLTAGE MAY BE PRESENT IN RF ELEMENT SOCKET - KEEP ELEMENT IN SOCKET DURING OPERATION.

DE LA TENSION H.F. PEUT ÊTRE PRÉSENTE DANS LA PRISE DE L'ÉLÉMENT H.F. - CONSERVER L'ÉLÉMENT DANS LA PRISE LORS DE L'EMPLOI.

HF-SPANNUNG KANN IN DER HF-ELEMENT-BUCHSE ANSTEHEN - ELEMENT WÄHREND DES BETRIEBS EINGESTÖPSELT LASSEN.

PUEDA HABER VOLTAJE RF EN EL ENCHUFE DEL ELEMENTO RF - MANTENGA EL ELEMENTO EN EL ENCHUFE DURANTE LA OPERACION.

IL PORTAELEMENTO RF PUÒ PRESENTARE VOLTAGGIO RF - TENERE L'ELEMENTO NELLA PRESA DURANTE IL FUNZIONAMENTO.

About This Manual

This manual covers the operating and maintenance instructions for the following models:

43	43P	4301	4305A	4431	4527
4521	4522	4526			

Changes to this Manual

We have made every effort to ensure this manual is accurate. If you discover any errors, or if you have suggestions for improving this manual, please send your comments to our Solon, Ohio factory. This manual may be periodically updated. When inquiring about updates to this manual refer to the part number and revision on the title page.

Literature Contents

Chapter Layout

Introduction — Describes the features of the 43 Wattmeter, lists equipment supplied and optional equipment, and provides power-up instructions.

Theory of Operation — Describes how the 43 Wattmeter works and

Installation — Describes how to set up and prepare the 43 Wattmeter for use.

Operation — All instructions necessary to operate the equipment appears in this chapter.

Maintenance — Lists routine maintenance tasks as well as troubleshooting for common problems.

Model Differences — Describes how each individual models vary from each other.

Specifications — Specifications and parts information are included in this chapter.

TABLE OF CONTENTS

Safety Precautions	i
Safety Symbols	ii
Warning Statements	ii
Caution Statements	iii
Safety Statements	iv
About This Manual	vii
Changes to this Manual	vii
Chapter Layout	vii
Chapter 1 Introduction	1
Purpose and Function	1
Performance Characteristics and Capabilities	1
Chapter 2 Theory of Operation.	3
Traveling Wave Viewpoint	3
Formulas	3
Coupling Circuit	3
Load Power	4
Standing Wave vs. traveling Wave Viewpoint (ρ vs. ϕ)	5
Low Reflection Measurements	7
Transmitter Monitoring	8
Component Testing	8
Measuring Insertion Loss	9
Frequency Response	9
Impedance Mismatch	10
Chapter 3 Installation	11
Connections	11
Replacing Quick-Change Connectors	11
Chapter 4 Operating Instructions	12
Normal Operation	12
Load Matching	16
Chapter 5 Maintenance	18
Troubleshooting	18
Cleaning	19
Contact Adjustment	19

Zero Adjust	20
Storage	20
Customer Service	21
Bird 43 Replacement Parts List	22
Bird 43 Replacement Parts List	22
Available “QC” Type Connectors	23
Chapter 6 Model Differences	24
Bird 43P Peak Wattmeter	24
Operation	24
Peak Detector Response	24
Rectangular Pulses	24
Peak Calibration	25
Maintenance	25
Bird 4301 Thruline Wattmeter	26
Bird 4305A Thruline Wattmeter	26
Bird 4305A Replacement Parts List	26
Bird 4431 Thruline Wattmeter	27
Maintenance	27
Bird 4431 Replacement Parts List	28
Bird 4520 Series Thruline Wattmeters	29
Installation	29
Operation	30
Bird 4520 Series Replacement Parts List	30
Chapter 7 Specifications	32
Limited Warranty	34

Purpose and Function

The 43 is an insertion-type RF wattmeter, designed to measure RF power and load match in 50 ohm coaxial transmission lines. It is intended for use with CW, AM, FM, and TV modulation, but not pulse modulation. When used in 50 ohm applications, the 43 has a maximum VSWR of 1.05 for frequencies up to 1000 MHz. The meter provides direct readings in watts with an expanded scale for easy reading. The scale is graduated for 25, 50, and 100 full scale. Elements are available in a variety of power and frequency ranges (see the Bird Electronic Corporation Catalog for details).

This manual covers the operation of the Bird 43 Thru-line Wattmeter and its descendants. Two models have RF sampler ports, while the Bird 43P can measure peak power. The Bird 4520 series comes ready for panel mounting. Differences are discussed in "[Model Differences](#)" on page 24. Except where indicated, instructions and specifications for the 43 apply to other models also.

Performance Characteristics and Capabilities

The Bird 43 is portable, with an attached carrying strap. It has an aluminum housing and an easily removed back cover, with bumpers on the base and back that allow the meter to stand or lie flat. For additional protection, the microammeter is specially shock mounted. A slotted screw on the lower front face of the meter is used to zero the pointer. Below the meter face, the RF line section protrudes slightly from the wattmeter housing with the element socket in the center.

The RF line section is precision machined to provide the best possible impedance match to the transmission line under test. A formed phosphor-bronze spring finger protrudes into the element socket to make contact with the element.

At each end of the line section are Bird Quick-Change RF connectors that may be interchanged with any other Bird "QC" connector. The wattmeter housing does not interfere with connector changes.

To make measurements, a Bird Plug-In Element is inserted into the line section socket and rotated against one of the stops. A small catch in the corner of the socket face presses on the shoulder of the element to keep it in proper alignment. This assures good contact between the spring finger and the element contact and between the lower edge of the element and the line section body (see [Figure 1](#)).

Figure 1 Securing an element

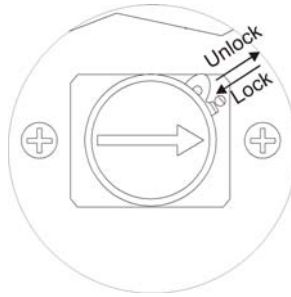

Contacts on opposite sides of the element connect with the spring finger when the element is in the forward or reverse position. This occurs when the stop pin on the element is against either stop and the catch is in place.

Figure 2 Bird 43 Thruline Wattmeter Outline Drawing

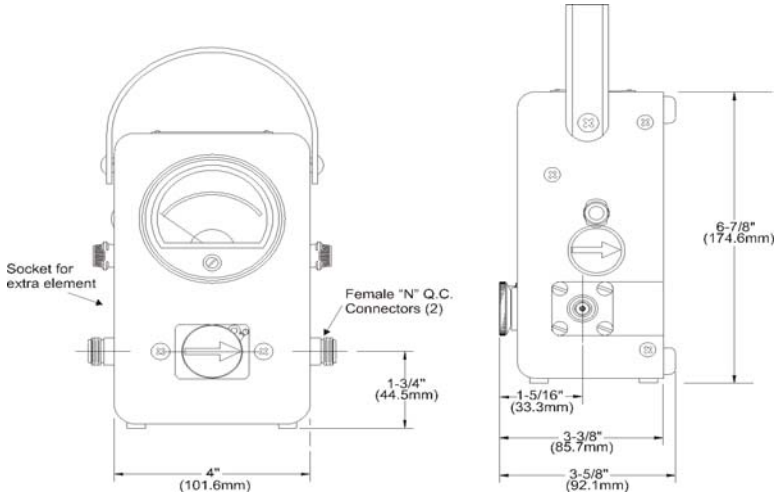

Traveling Wave Viewpoint

The easiest way to visualize Thru-line operation is from a traveling wave viewpoint. In transmission lines the voltages, currents, standing waves, etc., on any uniform line section result from the interaction of two traveling waves:

- **Forward Wave** (and its power) travels from the source to the load. It has RF voltage E_f and current I_f in phase, with $E_f / I_f = Z_0$.
- **Reflected Wave** (and its power) originates by reflection at the load and travels from the load back to the source. It has an RF voltage E_r and current I_r in phase, with $E_r / I_r = Z_0$.

Formulas

Each wave is mathematically simple and has a constant power:

Forward

$$V_f = \text{WattsForward} = E_f^2 / Z_0 = I_f^2 Z_0 = E_f I_f$$

Reflected

$$W_r = \text{WattsReflected} = E_r^2 / Z_0 = I_r^2 Z_0 = E_r I_r$$

Note: Z_0 is the characteristic impedance of a uniform line section. For useful lines it is usually a pure resistance of 50 ohms. The RF circuit of the Bird 43 is a length of uniform air line with $Z_0 = 50$ ohms.

Coupling Circuit

The coupling circuit that samples the traveling waves is in the Bird Plug-In Element. The element circuitry and its relationship to the rest of the Bird 43 are illustrated in [Figure 3](#).

Figure 3 Thruline Wattmeter Schematic

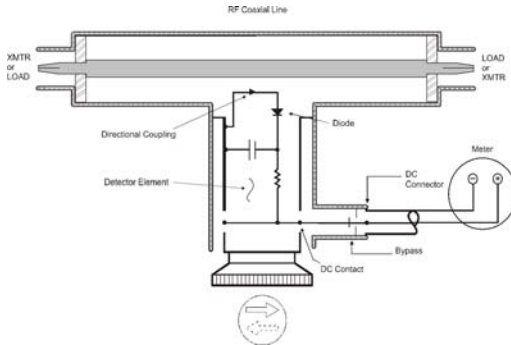

Current is produced in the coupling circuit by the traveling waves in the line section. Both inductive and capacitive coupling contribute to this. The inductive current flows in the direction of the traveling wave. The capacitive current is independent of the direction of the traveling wave. Therefore, the inductive current produced by one of the traveling waves will add in phase with the corresponding capacitive current, while that produced by the wave traveling in the opposite direction will subtract. The additive or “arrow” direction is assigned to the forward wave.

The electrical characteristics of the element are carefully adjusted so that, for the reverse traveling wave, the inductive current will completely cancel the capacitive current. The result is directivity greater than 25 dB. Thus, the element is sensitive at either of its settings, but to only one of the two traveling waves. Thruline Wattmeter measurements are also independent of position along the transmission line.

Like similar diode devices, the Bird 43 indicates the carrier component of amplitude modulation, with very little response to side band components added by modulation.

Load Power

For loads with a VSWR of 1.2 or less, the power dissipated in a load (W_l) is equivalent (with less than one percent error) to the forward power (W_f). When appreciable power is reflected, as with an antenna, it is necessary to use the exact load power which is given by:

$$W_l = \text{WattsIntoLoad} = W_f - W_r$$

Good load resistors, such as Bird Termline loads, will give negligible reflected power.

Standing Wave vs. traveling Wave Viewpoint (ρ vs. ϕ)

As mentioned previously, the ThruLine Wattmeter reacts to forward and reverse traveling waves to measure power in a transmission line. The standing wave viewpoint, also widely used, is highly developed both in theory and in practice. This viewpoint can be traced to the early use of slotted transmission lines.

The slotted line measures the standing wave ratio by mechanically positioning a voltage detector at peaks and nulls along a length of line section. Its drawbacks are that it is usually too long, too expensive for good accuracy, not portable, and too slow. These problems grow rapidly as the measurement frequency drops below 1000 MHz. The ThruLine Wattmeter by comparison is fast, convenient, and accurate. It provides the same information as a slotted line with the exception of the phase angle of the reflection coefficient (distance, load to minimum).

The simple relationships:

$$\rho = \frac{1 + \sqrt{\phi}}{1 - \sqrt{\phi}}$$

and

$$\phi = \left[\frac{\rho - 1}{\rho + 1} \right]^2$$

Note: Where $\rho = VSWR$ and $\phi = W_{\rho} / W_{\phi}$

These can be used to convert between the standing wave ratio (ρ) and the reflected/forward power ratio (ϕ), which can be directly read from the ThruLine Wattmeter. The relationship between ρ and ϕ is graphed in [Figure 4](#) and [Figure 5](#).

Note: Attenuation, measured in dB, can be derived from the power ratio by the equation $N_{db} = 10 \log \phi$.

VSWR scales and their attendant controls for setting the reference point have been intentionally omitted from the Bird 43. Experience using the ThruLine Wattmeter for transmitter tune-up, antenna matching, etc. will show that the power ratio measurement is as useful in practice as the standing wave ratio.

A trial is suggested – forget about VSWR for a few days and think in terms of $\phi = W_{\rho} / W_{\phi}$. The two meter readings, W_{ρ} and W_{ϕ} , give a useful, approximate picture of the results without bothering to calculate the power ratio exactly. Consider that, for an antenna matching problem, the main objective usually is to minimize W_r . Anything done experimentally to this end will be seen when the element is turned to the reflected power position.

Figure 4 Percent Reflected Power vs. VSWR (1.0 – 1.3)

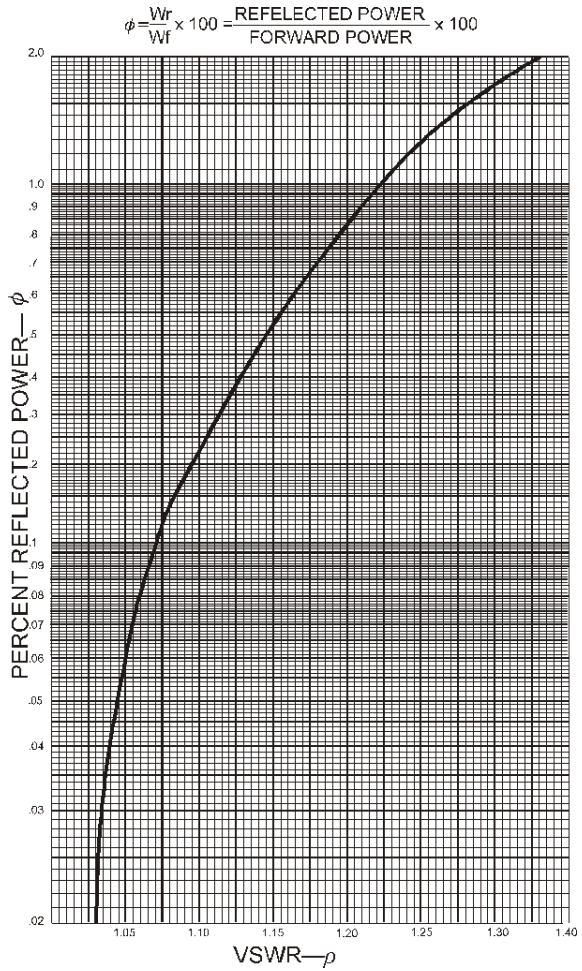
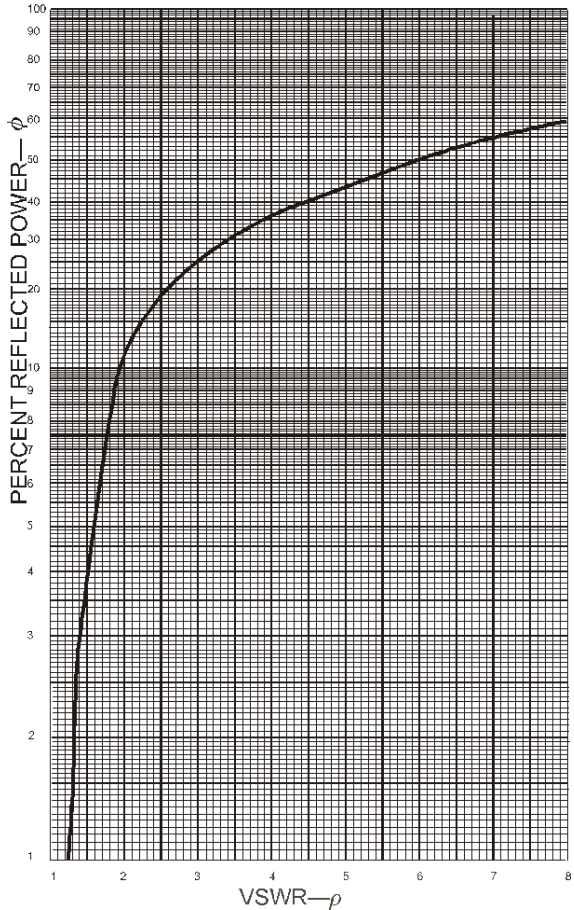

Figure 5 Percent Reflected Power vs. VSWR (1.0 – 8.0)

$$\phi = \frac{W_r}{W_f} \times 100 = \frac{\text{REFLECTED POWER}}{\text{FORWARD POWER}} \times 100$$



Low Reflection Measurements

$\phi = 10\%$ ($\rho = 2$) is the typical limit of antenna match. Further effort is frequently not worthwhile because below this level reflected power is hard to measure, and W_f can not be significantly increased. TV and VHF transmitters are examples of systems requiring lower reflected power but for reasons other than maximizing power transmission.

CAUTION

For low reflection measurements, do not rotate the reflected power element to read forward power. Damage to the element or wattmeter could result

When the same element is used to measure both forward and reflected power, meaningful readings are possible down to about $\phi = 5\%$ ($\rho = 1.5$). For accurate measurement of very low levels of reflected power, i.e. $\phi = 0.6\%$ ($\rho = 1.17$), use a second element rated at one tenth of the full scale power of the forward element. This method should not be used with element ranges differing by more than 10:1.

***Example** - Consider an 80 watt transmitter and a Bird 43 with 100 and 10 watt elements. Measure W_f with the 100 W element. Measure W_r using the 10 W element (with the arrow pointing towards the transmitter). W_r can be measured down to at least 0.5 W, so that $\phi = 0.5 / 80$ or about 0.6%, corresponding to $\rho = 1.17$.*

Transmitter Monitoring

The Thruline Wattmeter can be used for the continuous monitoring of transmitter output or reflected power, for instance in checking intermittent antenna or line faults.

Component Testing

The Bird 43 is very helpful in component testing, and may be employed in several ways:

- VSWR or ϕ may be measured by placing the component under test between the wattmeter and a good load resistor.
- Attenuation (power lost by heat in a line) as well as VSWR may be measured by inserting the unknown line between two Thruline wattmeters, or between a Thruline wattmeter and a Termaline absorption wattmeter.

Note: *Very small attenuations require allowance for normal instrument errors. To correct for this without any calculations, simply connect the wattmeters directly, with no line between them, and adjust their zero settings until they are both zeroed.*

- Line loss using open circuit calibration: The high directivity of elements can be exploited in line loss measurements, because of the equality of forward and reflected power with the load connector open or short circuited. In this state the forward and reflected waves have equal power, so that $\phi = 100\%$ and $\rho = \infty$. Open circuit testing is preferred to short circuit, because a high quality open circuit is easier to create than a high quality short.

Measuring Insertion Loss

1. Check forward and reverse power equality with a high quality open circuit,
2. Connect an open-circuited, unknown line to the wattmeter.
3. Measure the line twice (once down and once back).

Note: The measured ϕ is the attenuation for two passes along the line.

4. Compare the attenuation with published data for line type and length (remember to halve N_{db} or double the line length to account for the measurement technique).

Note: This measurement should be supplemented by either time domain reflectometry or DC continuity and leakage checks, since the attenuation measurement alone cannot account for faults such as open or short circuits partway down the line.

Note: Very small attenuations require allowance for normal instrument errors. Make sure to note exact readings, or their difference, on the initial equality check, and correct for this.

Frequency Response

Bird Plug-In Elements have a flat frequency response over their specified operating range. A sample set of curves is shown in [Figure 6](#). Notice that for the low power element, the rolloff outside its frequency band is more pronounced than for the high power elements.

Example - At 40 MHz the 10C element will have a loss of 4 dB, giving a reading of about 40% of the true value. For the 100C, the loss will only be about 1 dB, for a reading at 80% of the true value, and the 500C should be within the normal 5% of full scale tolerance.

Figure 6 Representative Frequency Response

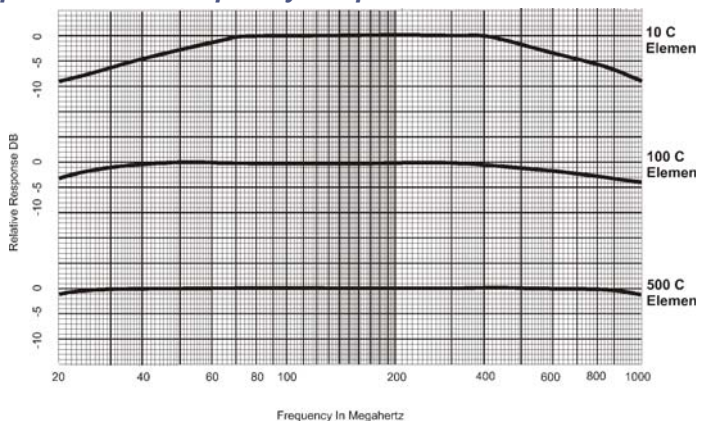

These curves are typical for all element types (H, A, B, C, D, ...) at their respective frequencies. Since a C type element has a frequency range of 100 - 250 MHz, response curves for other element types can be approximated by replacing the 100 and 250 MHz points on the chart with the extremes of the element's frequency range, and recalculating the other frequency points accordingly.

Example - For a B element (range 50 - 125 MHz) simply divide all frequencies by two. For an E element (range 400 - 1000 MHz) multiply all frequencies by four.

Harmonics or subharmonics that lie outside of the frequency range of the element may exist in the circuit under test. A rough approximation of the element's response to harmonics can be made with these curves. Using an element for measurements outside of its frequency range is not recommended. The response curves presented are only typical, and not guaranteed.

Impedance Mismatch

There may be cases where it is necessary to use the Bird 43 with a non-50 ohm transmission line. If the reflected power is less than 10% and the frequency is below 200 MHz, the resulting mismatch will not be too serious. At higher test frequencies and/or higher reflected power levels, the load impedance will change when the wattmeter is removed from the circuit.

When the line and load impedances are known, the system's VSWR equals the ratio of the two. Always divide the larger impedance by the smaller, since VSWR must always be greater than 1.

Example - Consider using a Bird 43 to tune a 70 ohm line. If the load impedance is also 70 ohms, the wattmeter will measure a VSWR of $70/50 = 1.4$. However, if the wattmeter is removed, the VSWR will actually be 1.0. Similarly, if the load impedance is 35.7 ohms, the VSWR will be $50/35.7 = 1.4$ with the wattmeter and $70/35.7 = 2.0$ without it.

Caution must therefore be used, since both good and bad matches can have the same measured VSWR. In this case, the correct impedance can be determined by slightly changing the load impedance. When the load impedance is near 70 ohms, the Bird 43 will read increasing VSWR as the load impedance is increased.

Note: When working with non-50 ohm lines, it is especially important to calculate the load power by subtracting the reflected power from the forward power.

When transporting the Bird 43, insert the original dust plug, or an element with the arrow pointing upward, in the element socket and secure with the catch. This will shunt the meter circuit and protect the meter by dampening needle action during handling and shipping. Also, secure spare elements in their sockets with the pivoting knob; just insert the element and twist the knob one-quarter turn.

CAUTION

Handle elements with care. Calibration could be disturbed if they are dropped.

Connections

WARNING

Leaking RF energy is a potential health hazard. Never attempt to connect or disconnect equipment from the transmission line while RF power is being applied. Severe burns, electrical shock, or death can occur.

Insert the Bird 43 in coaxial transmission lines of 50 ohms nominal impedance. The RF source can be connected to either side of the wattmeter without affecting readings.

If non-50 ohm cables are used, a mismatch will occur causing inaccuracies in readings. However, if a mismatch cannot be avoided, refer to "[Impedance Mismatch](#)" on page 10 for instructions.

It is strongly advised that this condition be avoided.

The Bird 43 is normally supplied with Quick-Change Female N type connectors. Other Bird "QC" connectors are available, refer to the Replacement Parts List in the Maintenance Chapter.

Replacing Quick-Change Connectors

1. Remove the 8-32 screw at each corner of the connector
2. Pull it straight outward.
3. Install the new connector by reversing Steps 1 and 2.

WARNING

When working with RF powers of 200 watts or more, the potential of the center conductor of the line section will exceed 100 volts. Do not touch the center conductor while RF power is on.

The Bird 43 uses plug-in elements to make measurements. The element's frequency range and maximum power are listed on its label. The transmitter test frequency should be within the band of the element used. See "[Frequency Response](#)" on page 9 for information on using the elements outside of their specified frequency range.

The arrow on the element indicates directional sensitivity; i.e., the direction of power flow that the meter will read. Rotate the element to select forward or reverse power measurement.

Combining the ThruLine Wattmeter with a Bird Termline Load Resistor creates an accurate absorption wattmeter. With this combination, readings only need to be taken in the forward direction because the reflected power will be negligible.

Normal Operation

1. Insert the appropriate element in the line section socket.
2. Turn the element so that the arrow points towards the load to measure forward power and towards the source for reflected power.
3. Turn on the RF source.
4. Read the power using the scale whose full-scale marking matches the element's maximum power.

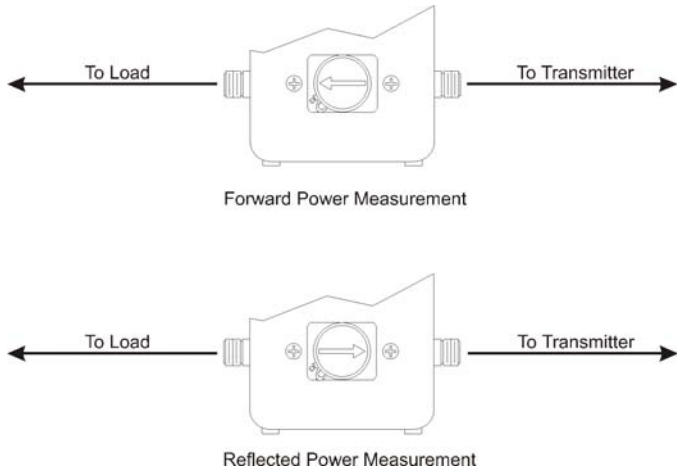
Figure 7 Element Direction

When readings are being made with the wattmeter connected to an auxiliary RF line section, do not put an element in the unused line section. Otherwise, the DC circuit will be unbalanced or shorted, causing inaccurate or zero power readings.

For convenience, a set of VSWR conversion nomographs is included in this manual. With these charts, VSWR may be determined from the forward and reflected power readings. Find the intersection of the forward and reflected power measurements. The slanted line passing closest to this point indicates the VSWR.

Figure 8 VSWR Conversion Graph (Reflected Power 0.2 – 20.0)

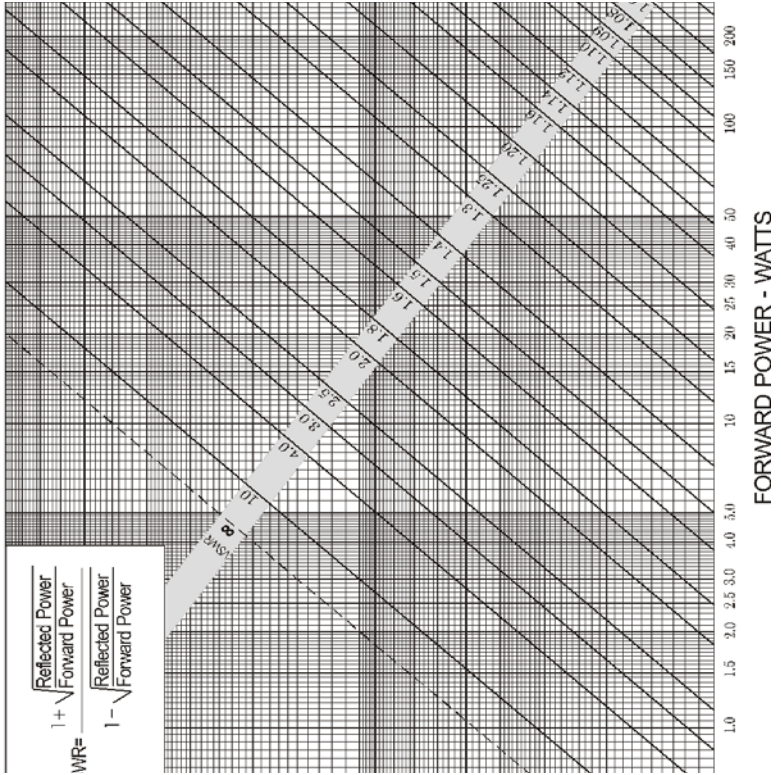
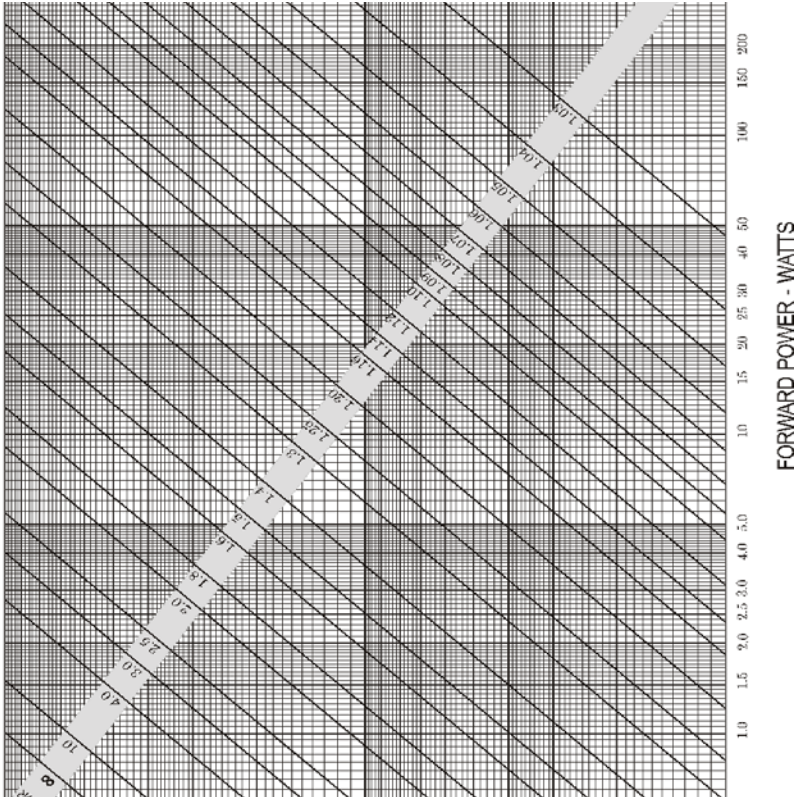

Figure 9 VSWR Conversion Graph (Reflected Power 0.01 – 1.00)



Load Matching

When a Bird 43 is used to tune a load to a transmitter and a good match is obtained, removing the unit will not change the match quality. A good 50 ohm load can terminate a 50 ohm transmission line of any length without altering conditions at the transmitter. The 43 is just an extra length of 50 ohm line in series with the measurement.

When the load is not well matched (an antenna with a VSWR of 1.5 or 2.0) the line length between the load and the transmitter will transform the load impedance as seen at the transmitter. Removing the wattmeter shortens the total line length by four inches plus two connectors. This is still not significant at low frequencies where five inches is a small fraction of a wavelength, but at higher frequencies the frequency or power output of the transmitter may be affected.

Transmission line theory shows that if the line length changes by exactly $\frac{1}{2}$ wavelength, the impedance is unchanged. To have identical match with the wattmeter in or out of the circuit, insert or remove $\frac{1}{2}$ wavelength of line (including the unit). To do this, use a length of cable which, when added to the unit, equals a $\frac{1}{2}$ wavelength at the frequency of interest. If multiple frequencies are needed, a separate cable length is required for each. See [Figure 10](#) for sample cable lengths.

Note: *Cable length is measured from end to end of the connector's outer conductor, except for UHF or mini-UHF plugs where the length is measured from tip to tip of the center pins.*

Note: *Dimensions shown are for solid polyethylene cable like RG-58C/U or RG-8/U, which have a velocity of propagation 66% of that of air. If RG-58 or RG-8 type cables containing foam polyethylene (velocity of propagation of 79%) are used, the dimensions in the graph must be multiplied by the ratio of the relative velocities; $79\% \div 66\% = 1.2$ in this case.*

Figure 10 Cable Length / Wavelength Matching

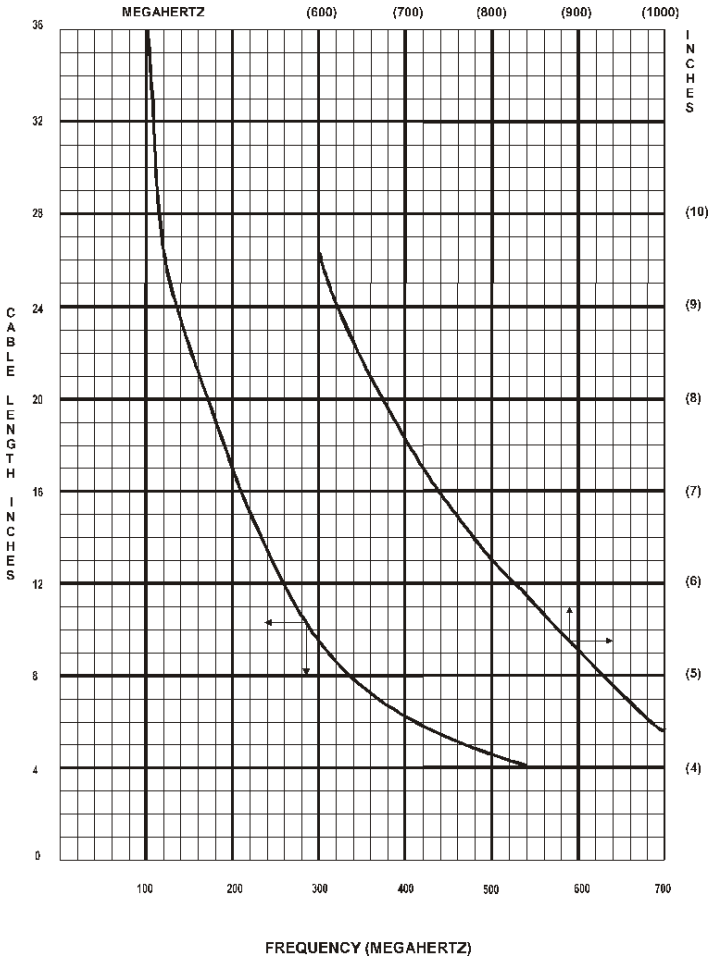

The rugged and simple design of the Bird 43 means that it requires minimal routine maintenance.

Troubleshooting

The following table contains troubleshooting information for problems that can occur during normal operation. Find the problem on the table, review possible causes, and perform the corrective action listed.

This manual does not list all malfunctions that may occur, or all corrective actions. If a malfunction is not listed or not corrected by the listed actions, contact the nearest Bird Service Center for assistance.

Problem	Possible Cause	Corrective Action
No meter reading	No RF power	Check RF source
	“Arrow” on element pointing wrong way	Rotate element
	DC contact bent	Adjust contact (page 19)
	Open or short circuit in meter	Replace defective cable (RG-58/U)
	Meter burned out or damaged	Return wattmeter for service
Intermittent or inconsistent meter reading	Dirty DC contact on element	Clean contact (page 19)
	Faulty transmission line or antenna	Inspect line
	Sticky or defective meter	Return wattmeter for service
High VSWR or reflected power	Foreign material in line section or in RF connector	Clean connectors (page 19)
	Open or shorted transmission line	Inspect line
	Bad load or poor connectors	Inspect load, antenna, and connectors

Cleaning

It is important to keep the following surfaces clean:

- Socket bore
- DC contacts on the element
- Teflon insulators

If any of the contacts or line connectors are dirty, clean them with a cotton swab dipped in commercial contact cleaner or isopropyl alcohol.

CAUTION

Do not attempt to remove the RF center conductor. This will damage the line section.
--

If the RF line section seems dirty, do not loosen any connections. Clean accessible components as described above and use dry, clean air to blow out the interior.

The outside of the meter housing can be cleaned with a soft cloth dampened with a mild detergent solution. Do not wipe the meter glass with a dry cloth, or a static charge could develop that would cause an erroneous meter indication.

Contact Adjustment

When cleaning the socket bore, do not disturb the spring finger of the DC contact. If necessary, the contact can be adjusted manually. The button must be out far enough to maintain good contact, but not so far as to interfere with easy entry of the element body. To remove the DC jack and spring finger:

1. Unscrew both 4-40 fillister head screws holding the jack assembly against the side of the RF line section.
2. Retract the assembly.

Note: *Be careful not to lose the small Teflon bead that straddles the base of the spring and nests in a counterbore on the side of the line section.*

3. Replace the assembly.

Note: *Make sure that the bead is properly inserted) and the two screws.*

Zero Adjust

The meter's zero setting should be checked when no RF power is present. When no power is applied the pointer should rest exactly on zero. If adjustment is required, turn the adjustment screw until the pointer is set at zero (see [Figure 11](#)).

Figure 11 Zero Adjust

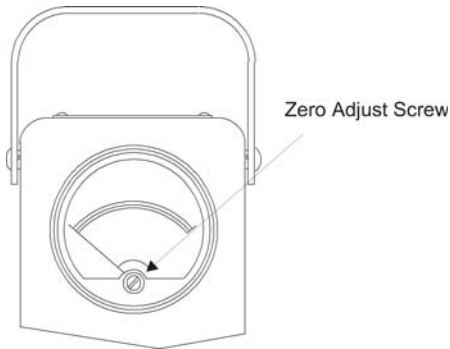

Storage

When storing the meter, keep an element or dust plug in the element socket to prevent the intrusion of dust and to prevent damage to the meter movement. When using an element, use the highest power element available. Turn it so that the "arrow" points up (midway between the FWD and RFL positions). This protects the meter and will not expose the element diode to dangerous potentials should the line section be energized.

Customer Service

Any maintenance or service procedure beyond the scope of those in this chapter should be referred to a qualified service center.

If the unit needs to be returned for any reason, request an Return Material Authorization (RMA) through the Bird Technologies website. All instruments returned must be shipped prepaid and to the attention of the RMA number.

Bird Service Center

30303 Aurora Road
Cleveland (Solon), Ohio 44139-2794
Fax: (440) 248-5426
E-mail: bsc@birdrf.com

For the location of the Sales Office nearest you, visit our Web site at:

<http://www.birdrf.com>

Bird 43 Replacement Parts List

Note: See "[Customer Replacement Parts](#)" on page 28

Description	Qty.	Part Number
Housing Assembly	1	4210-018
Cover Assembly	1	4210-005-1
Line Section Assembly	1	4230-018-1
Carrying Strap	1	8580A003
Dust Plug, Aluminum	1	3610-031
Microammeter	1	2080-002
Turnbutton	2	4300-015
Spring Washer	2	5-1144-1
Rubber Stem Bumper	8	5-1388
Pushnut	2	5-1076-1
Replacement Meter Kit	1	8-000
RF Connectors	2	See list on next page

Bird 43 Replacement Parts List

Customer Replacement Part	Consists of	Description
RPK43-1 - Housing Kit	4210-018	Housing
	923-RPK43-1	Instruction Sheet
RPK43-2 - Rear Cover Kit	4210-005-1	Cover
	923-RPK43-2	Instruction Sheet
RPK43-3 - Line Section Kit	4230-018-1	Line Section
	923-RPK43-3	Instruction Sheet
RPK43-4 - Meter Kit	8-000	Replacement Meter
	4220-087	Shock Mount
	923-RPK43-4	Instruction Sheet

Customer Replacement Part	Consists of	Description
RPK43-5 - External Hardware Kit	1118-0614-00	#8-32x3/8 Phillips Flathead Machine Screw
	1120-0820-00	#10-32x1/2 Phillips Oval Screw
	1136-0813-00	#10-32x1/2 Phillips Pan Screw
	5-1388	Rubber Bumper Stem
	5-1763	Gray Rubber Bumper Foot
	8240-054	Strap Spacer Screw
	8580A003	Plastic Handle
	923-RPK43-5	Instruction Sheet

Available “QC” Type Connectors

Connector	Part Number	Connector	Part Number
BNC-Female	4240-125	Open Term. # 10-32 Nut	4240-363
BNC-Male	4240-132	SC-Female	4240-090
C-Female	4240-100	SMA-Female	4240-336
C-Male	4240-110	SMA-Male	4240-334
HN-Female	4240-268	TNC-Female	4240-156
HN-Male	4240-278	TNC-Male	4240-160
LC-Female	4240-031	UHF-Female	4240-050
LC-Male	4240-025	UHF-Male	4240-179
LT-Female	4240-018	7/16" IEC (Jack) Type 169-4	4240-344
LT-Male	4240-012	7/16" IEC (Plug) Type 169-4	4240-080
Mini UHF-Female	4240-346	7/8" EIA	4240-002
N-Female	4240-062	1-5/8" EIA Fixed	4240-096
N-Male	4240-063	1-5/8" EIA Swivel	4240-208

Bird 43P Peak Wattmeter

The Bird 43P Thru-line Wattmeter is the same as the Bird 43, with the added capability of measuring peak power in AM, SSB, and some pulse applications. A conversion kit (P/N 4300-400) is available to give peak reading capability to any standard Bird 43. This kit comes with all necessary parts and easy to follow instructions for simple and quick conversion.

Special elements are not required. However, the element power rating must match the peak power to be measured.

Example - If 1000 watt peaks are expected, use a 1000 watt element.

Operation

There is a push button on/off switch on the right side of the meter.

- To read peak power, push the switch in. The red LED will light.
- To read CW power, push the switch again. The LED will turn off.

Peak Detector Response

Since the peak detector's response time is about one second, a short delay may be noticed before the meter reading stabilizes. This will also be noticed when the transmitter is turned off. In voice modulated systems, the meter reading may fluctuate by 2–3 minor scale divisions as the peak detector attempts to follow the power variations.

Rectangular Pulses

When measuring rectangular pulse power, note the following signal requirements:

- Duty Cycle: 2%, minimum
- Rep. Rate: 100 pps, minimum
- Pulse Width: 200 μ s, minimum

Peak Calibration

If recalibration is required, refer to figure 15 and these instructions:

1. Unscrew the four 8-32 flat head screws securing the back cover.
2. Grasp the back cover by the side tabs behind the line connectors and pull straight back to remove it.
3. Insert the Bird 43P between a reliable CW signal source and a 50 ohm load.
4. Insert an element with the appropriate power and frequency range into the Bird 43P. Turn it to read forward power.
5. Set the wattmeter to CW mode (LED off).
6. Turn on the signal source and adjust the source power to give a stable reading in the upper half of the wattmeter's scale.
7. Switch the wattmeter to PEAK mode (LED on).
8. Adjust the potentiometer (R9) until the PEAK reading is the same as the CW reading.
9. Replace the back cover.

Maintenance

Maintenance of the Bird 43P is the same as for the Bird 43 except for battery replacement. Battery life should typically be 48 hours.

If the unit does not function properly in peak mode or if calibration cannot be achieved, the batteries may be low. Replace with two new 9 V alkaline or lithium batteries. The batteries fit very tightly in their retaining clips and may have to be pried out one at a time.

Figure 12 Model 43P

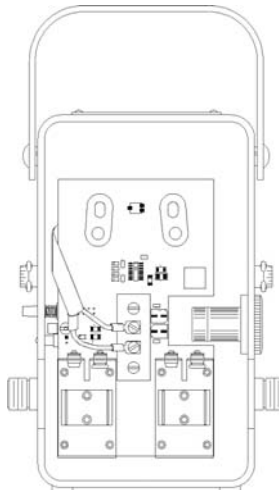

Bird 4301 Thruline Wattmeter

The Bird 4301 Thruline Wattmeter is the same as the Bird 43 except for the following physical differences:

The auxiliary DC connector on the Model 4301 can be used to connect to an accessory line section. Make the connection with a standard RG-58/U cable.

Bird 4305A Thruline Wattmeter

The Bird 4305A Thruline Wattmeter is the same as the Bird 43 except for the following physical differences:

- The Bird 4305A's dimensions are 4-5/16" L x 4"W x 6-7/8"H (110 x 102 x 175 mm), including element and bumper feet.
- The Bird 4305A's weight is 3.25 lb. (1.5 kg), including the element.
- The Bird 4305A does not have holders for spare elements.
- The Bird 4305A line section has higher operating power capability and is 1-5/8" in diameter, instead of 15/16" as in the Bird 43.

Theory, maintenance, and all instructions for the Bird 43 also apply to the Bird 4305A.

Bird 4305A Replacement Parts List

Customer Replacement Part	Consists of	Description
RPK4305-1 - Housing Kit	4305A003	Housing, Meter Assembly
	RPK4305-5	External Hardware Kit
	923-RPK4305-1	Instruction Sheet
RPK4305-2 - Rear Cover Kit	4305A002	Cover Assembly
	1118-0419-00	#8-32x1/4 Phillips Screw
	923-RPK4305-2	Instruction Sheet
RPK4305-3 - Line Section Kit	4305-005	Line Section Assembly
	923-RPK4305-3	Instruction Sheet
RPK4305-4 - Meter Kit	2150A015-1	Meter 25/50/100W
	4220-097-22	Cable, Coax/Assy 48 in
	923-RPK4305-4	Instruction Sheet
RPK4305-5- External Hardware Kit	1116-0400-00	#6-32X1/4 Pan Screws
	1120-0819-00	#10-32x1/2 Phillips Screws
	4285-002-4	Clamp Spacer
	923-RPK4305-5	Instruction Sheet

Bird 4431 ThruLine Wattmeter

The Bird 4431 RF Sampling Wattmeter is the same as the Bird 43 ThruLine Wattmeter except for an RF signal sampler probe.

The RF sampler provides a low power sample of the signal being transmitted through the wattmeter's linesection. This signal is available at the female BNC connector labeled "RF SAMPLE", on the right side of the housing. The signal level can be set with the control knob on the front of the meter. The table below lists approximate attenuation levels, and notes maximum suggested adjustment. The sampler output may be fed to any suitable RF signal monitoring device; e.g. a frequency counter, spectrum analyzer, or oscilloscope. All other operation instructions are the same as for the Bird 43.

Sampler at max (Fully clockwise)	
Freq. (MHz)	Atten. (dB)
2	69
10	57
25	46
50	42
75	39
100	36
200	31

Turned counter-clockwise 4 full turns from max*	
Freq. (MHz)	Atten. (dB)
300	38
400	34
500	30
600	29.5
700	29
800	28.5
900	28

Turned counter-clockwise 7 full turns from max*	
Freq. (MHz)	Atten. (dB)
800	36
900	35.5
1000	35

* Approximate attenuation

Maintenance

Do not make repairs to the probe assembly. If the sampler malfunctions, we recommend returning the unit to the Bird Service Center for repair. To replace the probe assembly, follow these instructions:

1. Access the probe by unscrewing the four 8-32 flat head screws that secure the back cover.
2. Grasp the back cover by the side tabs behind the line connectors and pull straight backward to remove it.
3. Remove the small coupling control knob on the front of the wattmeter with a 1/16 hex socket wrench.
4. Remove the two 8-32 x 1/4" screws fastening the guide and plate assembly to the back of the line section.
5. Put the control knob back on the shaft, then turn it counterclock-wise until the collar is free of the shaft.

6. Remove the control knob.
7. Pull the probe plate straight out of the pin and guide bushing.
8. Unscrew the 5/8 hex nut on the BNC connector and pull the sampler connector into the case. The probe plate assembly, P/N 4431-003, is now released and may be replaced.

Note: *The sampler cable (RG-58/U) center conductor is soldered to the probe's rear stub. The cable is secured to the side sleeve of the probe with the same screw used in the dc connector plug assembly, P/N 7500-076. It may be removed by unscrewing the 3/8 hex screw, unsoldering the lead tip and pulling out the cable. The probe assembly is formed into the socket and is not replaceable.*

9. Replace by carefully reversing the above procedure.

Note: *When inserting the control bushing, be sure the alignment pin is properly positioned.*

Bird 4431 Replacement Parts List

Customer Replacement Parts

Customer Replacement Part	Consists of	Description
RPK4431-1 - Housing Kit	4431-033	Housing
	RPK4431-4	Instruction Sheet
RPK4431-2 - Guide Plate, Line Section Kit	4431-002	Plate, Guide, Assembly
	4431-007	Line Section Assembly
	4431-003	Plate, Movable Assembly
	923-RPK4431-2	Instruction Sheet
RPK4431-3 - Meter Kit	4230-018	Line Section
	923-RPK43-3	Instruction Sheet
RPK43-4 - Meter Kit	2080-002	Meter Assembly
	5-1066	Strip, Shock
	4220-097-1	12 in Coax Cable
	4220-087	Mount, Shock Assembly
	4410A261	Pad, Neoprene Shock
	923-RPK4431-3	Instruction Sheet

Customer Replacement Part	Consists of	Description
RPK4431-4 - External Hardware Kit	8580A003	Handle, Plastic
	5-1388	Bumper, Stem Rubber
	5-1763	Bumper Ft, Gray Rubber
	1120-0820-00	#10-32x1/2 Phil Screws
	1118-0614-00	#8-32x3/8 Phil Screws
	1138-0813-00	#10-32x1/2 Phil Screws
	4431-035	Label, RF Sample
	8240-054	Spacer, Strap, Screw
	5-1193	Knob, Knurled BLK
	923-RPK4431-4	Instruction Sheet

Service Only Replacement Parts

Replacement Part	Consists of	Description
RP3610-031	3610-031 (5 per)	Aluminum Dust Plug
RP2080-002	2080-002	25/50/100W Mater
RP4300-015	4300-015	Molded Turnbutton
RP5-1388	5-1388	Rubber Bumper Stem

Bird 4520 Series ThruLine Wattmeters

The Bird 4520 RF ThruLine Wattmeters (models 4521, 4522, 4526, 4527) are the same as the Bird 43, except that they are panel mounted for rack installation. In addition, the Bird 4527 has a RF sampler. These units are intended for fixed installation, generally in rack mounts requiring 19" panels.

Installation

1. Choose a location allowing easy reading and operation of the unit and where the cables used will be short and without sharp bends.

Note: *Avoid the use of angles and adapters.*

2. Make sure all connectors are tightened securely.
3. Use four 12-24 screws to fasten the wattmeter panel to the rack.

Operation

The RF sampler on the Bird 4527 provides a low power sample of main RF signal. This signal is available at the female BNC connector labeled “RF SAMPLE”. The sampler output may be fed to any RF signal suitable monitoring device; e.g. a frequency counter, spectrum analyzer, or oscilloscope.

Bird 4520 Series Replacement Parts List

The mounting panel entry lists the panel styles for each model. Only parts which are not used on the Bird 43 are listed here.

4521 Replacement Parts

Customer Replacement Part	Consists of	Description
RPK4521-1 - Line Section Kit	4230-018	Line Section Assembly
	923-RPK4521-1	Instruction Sheet
RPK4521-2 - Meter Kit	2080-002	Meter 25/50-100W
	4220-097-5	Cable, Coax/Assembly 16 in
	923-RPK4521-2	Instruction Sheet
RPK4521-3 - Front Panel Kit	4521-002	Panel, Blank
	923-RPK4521-3	Instruction Sheet
RPK4521-4 - External Hardware Kit	1116-0801-25	#6-32x1/2 Round MS Screw
	1132-0201-00	#6 Split Lock Washer
	1131-0200-00	#6-32 Hex Nut SS
	1120-0820-00	#10-32x1/2 Phillips Screws
	5A2315-2	Label, Safety Symbol
	1118-0614-00	#8-32x3/8 Phillips Screws
	4285-002-2	Spacer
	923-RPK4521-4	Instruction Sheet

4522 Replacement Parts

Customer Replacement Part	Consists of	Description
RPK4522-1 - Line Section Kit	4522-002-7	Line Section Assembly
	4304-026	Label, Mylar
	923-RPK4522-1	Instruction Sheet
RPK4522-2 - Meter Kit	2080-002	Meter 25/50-100W
	5A2177	Facenut, Beveled
	5A2154	Switch, Toggle
	4522-013	Cable, Assembly
	923-RPK4521-2	Instruction Sheet
RPK4522-3- External Hardware Kit	1116-0801-25	#6-32x1/2 Round MS Screw
	1132-0201-00	#6 Split Lock Washer
	1131-0200-00	#6-32 Hex Nut SS
	1120-0820-00	#10-32x1/2 Phillips Screws
	1132-0406-00	#10 External Lock Washer
	5A2315-2	Label, Safety Symbol
	1131-0400-00	#10-32 Hex Nut SS
	5A2290-2	Label, RFL
	5A2290-1	Label, FWD
	923-RPK4522-3	Instruction Sheet
RPK4522-4 - Front Panel Kit	4522-006	Panel, Mounting
	5A2290-2	Label, RFL
	5A2290-1	Label, FWD
	923-RPK4522-4	Instruction Sheet

4526/27 Replacement Parts

Customer Replacement Part	Consists of	Description
RPK2080-002	2080-002	Meter 25/50-100W

Service Only Replacement Parts

Replacement Part	Consists of	Description
4526-004	4526-004	Panel
4527-005	4527-005	Panel
4527-002	4527-002	Line Section Assembly
4430-002	4430-002	RF Cable Assembly (4527 only)

These specifications include data covering the Bird 43, 43P, 4305A, 4431, 4521, 4522, 4526, and 4527. Specifications for models not listed are identical to the Bird 43.

Impedance, Nominal	50 ohm
VSWR, Max.	
All models except 4431	1.05:1
4431	1.07:1 (when coupling is less than 30 dB)
Connectors	
Primary Line	Bird "QC" (N Female normally supplied)
RF Sampling (on applicable models)	Female BNC
Power and Frequency Range (element dependent)	
43,43P,4521/22/26	100 mW – 10 kW 0.45 – 2700 MHz
4305	25 kW max, 0.45 – 2.5 MHz 10 kW max, 2 – 30 MHz
4431	5000 W max, 2 – 30 MHz 1000 W max, 30 – 1000 MHz
4527	1000 W max, 2 – 200 MHz 500 W max, 200 – 512 MHz
RF Coupling	
4527 (approximate)	-53 dB, 512 – 10 MHz -70 dB, 10 – 2 MHz
4431 (adjustable)	15 – 70 dB
Insertion Loss (4431 only)*	
2 – 512 MHz	0.1 dB max
512 – 1000 MHz	0.1 dB max
Accuracy	
CW (all models)	± 5% of full scale
Peak Power (43P only)	± 8% of full scale
Power Requirement (43P only)	Two 9V alkaline batteries (NEDA 1604)
Battery Life (43P only)	48 hours typical
Dimensions, Nominal	
43, 43P	3-5/8"L x 4"W x 6-7/8"H (92 x 102 x 175 mm)

4305A	4-1/4"L x 3-7/8"W x 6-7/8"H (108 x 99 x 175 mm)
4431	3-7/8"L x 4"W x 6-7/8"H (99 x 102 x 175 mm)
4521/22/26/27	19"W x 5-1/4"H x 1-3/4"D (483 x 134 x 45 mm)
Approximate Weight with N-Connectors	
4521/22/26/27	3 lb. (1.36 kg)
43, 43P, 4431	4 lb. (1.8 kg)
4305A	3.43 lb. (1.6 kg)
Operating Position	Any
Finish	Grey Powder Coat

* Applicable only for maximum coupling less than 30 dB. This requires a minimum decoupling of four full turns counterclockwise above 200 MHz, and seven full turns above 800 MHz

Limited Warranty

All products manufactured by Seller are warranted to be free from defects in material and workmanship for a period of one (1) year, unless otherwise specified, from date of shipment and to conform to applicable specifications, drawings, blueprints and/or samples. Seller's sole obligation under these warranties shall be to issue credit, repair or replace any item or part thereof which is proved to be other than as warranted; no allowance shall be made for any labor charges of Buyer for replacement of parts, adjustment or repairs, or any other work, unless such charges are authorized in advance by Seller.

If Seller's products are claimed to be defective in material or workmanship or not to conform to specifications, drawings, blueprints and/or samples, Seller shall, upon prompt notice thereof, either examine the products where they are located or issue shipping instructions for return to Seller (transportation-charges prepaid by Buyer). In the event any of our products are proved to be other than as warranted, transportation costs (cheapest way) to and from Seller's plant, will be borne by Seller and reimbursement or credit will be made for amounts so expended by Buyer. Every such claim for breach of these warranties shall be deemed to be waived by Buyer unless made in writing within ten (10) days from the date of discovery of the defect.

The above warranties shall not extend to any products or parts thereof which have been subjected to any misuse or neglect, damaged by accident, rendered defective by reason of improper installation or by the performance of repairs or alterations outside of our plant, and shall not apply to any goods or parts thereof furnished by Buyer or acquired from others at Buyer's request and/or to Buyer's specifications. Routine (regularly required) calibration is not covered under this limited warranty. In addition, Seller's warranties do not extend to the failure of tubes, transistors, fuses and batteries, or to other equipment and parts manufactured by others except to the extent of the original manufacturer's warranty to Seller.

The obligations under the foregoing warranties are limited to the precise terms thereof. These warranties provide exclusive remedies, expressly in lieu of all other remedies including claims for special or consequential damages. SELLER NEITHER MAKES NOR ASSUMES ANY OTHER WARRANTY WHATSOEVER, WHETHER EXPRESS, STATUTORY, OR IMPLIED, INCLUDING WARRANTIES OF MERCHANTABILITY AND FITNESS, AND NO PERSON IS AUTHORIZED TO ASSUME FOR SELLER ANY OBLIGATION OR LIABILITY NOT STRICTLY IN ACCORDANCE WITH THE FOREGOING.