

3.1 - CAJA RECTANGULAR. A PRUEBA DE INTEMPERIE. SERIE RR.

3.1 - WEATHERPROOF SINGLE GANG BOX. RR SERIES.

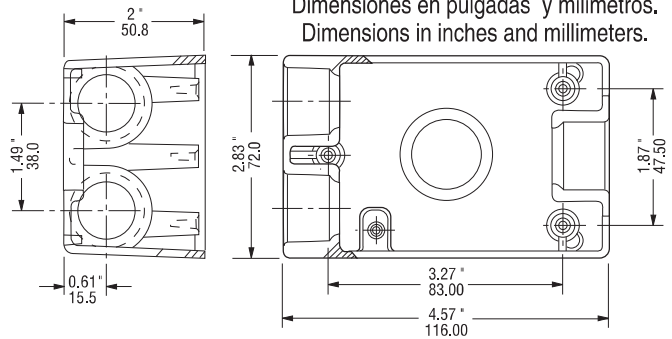

- Material: Aluminio inyectado a presión (diecast).
- Acabados: Pintura electrostática epoxica/poliéster polimerizada.
- Tornillo de tierra pasivado incluido.
- A prueba de intemperie cuando se usa tapa con empaque.
- Rosca NPT para usarse con tubo conduit RIGIDO e IMC.

APLICACIONES:

- Pueden ser instaladas para recibir accesorios como: Interruptores, contactos, estaciones de botones, luces piloto.
- Sirven para hacer empalmes y conexiones en el cableado. Permite fácil acceso para mantenimiento.
- Fabricación en base a: UL 514 A, UL 514 B
CAN/CSA-C22.2 No. 18-92

- Material: Diecast aluminum
- Finish: Electrostatic powder epoxy/poliéster coating.
- Green ground screw included.
- For wet location when gasketed cover are used.
- NPT threaded for use with RIGID and IMC conduit.

APPLICATIONS:

- They can be installed to accommodate accessories such as switches, receptacles.
- Provide openings for making splice and taps. Allow access for maintenance.
- Manufactured in compliance with: UL 514 A, UL 514 B
CAN/CSA-C22.2 No. 18-92

USAR No. DE CODIGO PARA HACER PEDIDOS / TO ORDER USE CODE NUMBER

Figura Figure	Bocas Hubs	Catalogo Catalog	Codigo Code	Medida nominal Hub size		Volumen Volume		Peso x 100 pzas. Weight x 100 pcs.		Pqt. Pzas. Pcs.	Unit. Pzas. Pcs.	Ship. Pzas. Pcs.	Std. Pzas. Pcs.
				mm	inch	cm ³	cu. in	kg	Lb				
	Arriba/Top 1	RR-0505	01.01.0505	12.7	1/2"	308.3	18.8	22.0	48.5				40
		RR-0506	01.01.0506	19.0	3/4"	308.3	18.8	19.5	42.9				40
		RR-2631	01.01.2631	25.4	1"	246.0	15.0	27.0	58.3				40
	Arriba/Top 1 Abajo/Bottom 1	RR-0470	01.01.0470	12.7	1/2"	300.1	18.3	24.0	52.9				40
		RR-0471	01.01.0471	19.0	3/4"	295.2	18.0	22.0	48.5				40
		RR-2742	01.01.2742	25.4	1"	246.0	15.0	27.0	58.3				40
	Arriba/Top 1 Abajo/Bottom 2	RR-0472	01.01.0472	12.7	1/2"	275.5	16.8	29.5	65.0				40
		RR-0473	01.01.0473	19.0	3/4"	275.5	16.8	26.5	58.4				40
	Arriba/Top 1 Abajo/Bottom 1 Izquierda/Left 1	RR-0480	01.01.0480	12.7	1/2"	275.5	16.8	30.0	66.1				40
		RR-0481	01.01.0481	19.0	3/4"	275.5	16.8	27.5	60.6				40
		RR-2743	01.01.2743	25.4	1"	234.5	14.3	28.5	62.7				40
	Arriba/Top 1 Abajo/Bottom 1 Izquierda/Left 1 Derecha/Right 1	RR-0474	01.01.0474	12.7	1/2"	275.5	16.8	32.5	71.6				40
		RR-0475	01.01.0475	19.0	3/4"	275.5	16.8	26.5	58.4				40
		RR-2744	01.01.2744	25.4	1"	234.5	14.3	28.5	62.7				40

Especificaciones sujetas a cambio sin previo aviso. Specifications are subject to change without notice..

RAWELT, S.A. de C.V.

RAWELT® INYECTADOS
Una División del Grupo REVUELTA

3.1 - CAJA RECTANGULAR. A PRUEBA DE INTEMPERIE. SERIE RR.

Hoja: 2 / 7
Page:

3.1 - WEATHERPROOF SINGLE GANG BOX. RR SERIES.

FICHA TECNICA / TECHNICAL DATA

007 - RW - 154

USAR No. DE CODIGO PARA HACER PEDIDOS / TO ORDER USE CODE NUMBER

Figura Figure	Bocas Hubs	Catalogo Catalog	Codigo Code	Medida nominal Hub size		Volumen Volume		Peso x 100 pzas. Weight x 100 pcs.		Pqt. Unit. Pzas. Pcs.	Unit. Ctn. Pzas. Pcs.	Ship. Ctn. Pzas. Pcs.	Std. Pkg. Pzas. Pcs.
				mm	cu. in	cm ³	cu. in	kg	Lb				
	Arriba/Top 22	RR-0476	01.01.0476	12.7	1/2	267.3	16.3	30.5	67.2				40
	Abajo/Bottom	RR-0477	01.01.0477	19.0	3/4	267.3	16.3	26.0	57.3				40
	Arriba/Top 1	RR-0478	01.01.0478	12.7	1/2	267.3	16.3	32.0	70.5				40
	Abajo/Bottom 1	RR-0479	01.01.0479	19.0	3/4	267.3	16.3	28.5	62.8				40
	Izquierda/Left 2												
	Derecha/Right 1												
	Arriba/Top 1	RR-0507	01.01.0507	12.7	1/2	308.3	18.8	21.0	46.2				40
	Detrás/Back 1	RR-0508	01.01.0508	19.0	3/4	303.4	18.5	18.5	40.7				40
		RR-2745	01.01.2745	25.4	1	246.0	15.0	27.0	58.3				40
	Arriba/Top 1	RR-0281	01.01.0281	12.7	1/2	300.1	18.3	24.5	54				40
	Abajo/Bottom 1	RR-0282	01.01.0282	19.0	3/4	295.2	18.0	31.0	68.3				40
	Detrás/Back 1	RR-2746	01.01.2746	25.4	1	246.0	15.0	27.0	58.3				40
	Arriba/Top 1	RR-0283	01.01.0283	12.7	1/2	275.5	16.8	29.0	63.9				40
	Abajo/Bottom 2	RR-0284	01.01.0284	19.0	3/4	275.5	16.8	26.0	57.3				40
	Detrás/Back 1												
	Arriba/Top 1	RR-0454	01.01.0454	12.7	1/2	275.5	16.8	29.5	65.0				40
	Abajo/Bottom 1	RR-0455	01.01.0455	19.0	3/4	275.5	16.8	27.0	59.5				40
	Izquierda/Left 1	RR-2747	01.01.2747	25.4	1	234.5	14.3	28.5	62.7				40
	Detrás/Back 1												
	Arriba/Top 1	RR-0285	01.01.0285	12.7	1/2	275.5	16.8	32.0	70.5				40
	Abajo/Bottom 1	RR-0286	01.01.0286	19.0	3/4	275.5	16.8	26.0	57.3				40
	Izquierda/Left 1	RR-2748	01.01.2748	25.4	1	234.5	14.3	28.5	62.7				40
	Derecha/Right 1												
	Detrás/Back 1												
	Arriba/Top 2	RR-0287	01.01.0287	12.7	1/2	267.3	16.3	29.5	65.0				40
	Abajo/Bottom 2	RR-0288	01.01.0288	19.0	3/4	267.3	16.3	25.5	56.2				40
	Detrás/Back 1												
	Arriba/Top 1	RR-0289	01.01.0289	12.7	1/2	267.3	16.3	31.5	69.4				40
	Abajo/Bottom 1	RR-0290	01.01.0290	19.0	3/4	267.3	16.3	28.0	61.7				40
	Izquierda/Left 2												
	Derecha/Right 1												
	Detrás/Back 1												

Certificaciones / Compliances: Expediente/File No. LR 105795-1

Expediente/File No. E135600

Cajas 25.4 1"
 Boxes 25.4 1"

Especificaciones sujetas a cambio sin previo aviso. Specifications are subject to change without notice..

RAWELT, S.A. de C.V.

RAWELT ® INYECTADOS
Una División del Grupo **REVELTA**

**3.1 - CAJA RECTANGULAR. A PRUEBA DE INTEMPERIE. SERIE RR.
TAPA RECTANGULAR. ALUMINIO.**

**3.1 - WEATHERPROOF SINGLE GANG BOX. RR SERIES.
SINGLE GANG COVER. ALUMINUM.**

TAPA

- Lámina de aluminio troquelada.
- Uso en interiores.
- Tornillos galvanizados incluidos.

EMPAQUE

- PVC

TAPON

- Aluminio inyectado a presión (diecast).

COVER

- Sheet aluminum.
- For use indoors.
- Galvanized mounting screws included.

GASKET

- PVC.

CLOSE UP PLUG

- Die cast aluminum.

Dimensiones en milímetros y pulgadas.
Dimensions in inches and millimeters.

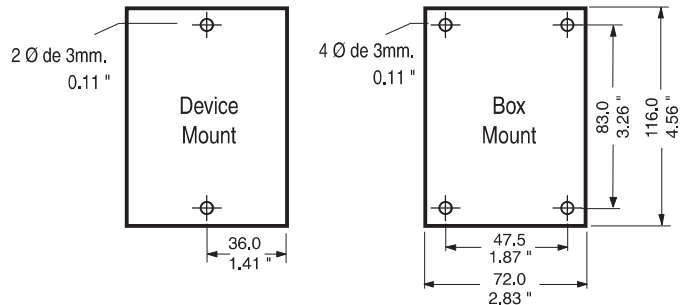

LISTED
1M70



USAR No. DE CODIGO PARA HACER PEDIDOS / TO ORDER USE CODE NUMBER

Figura Figure	Catalogo Catalog	Codigo Code	Descripción Description	Cant. Diam. Qty.	Espesor Thickness		Peso x 100 pzas. Weight x 100 pcs.		Pqt. Unit Pzas. Pcs.	Unit Ctn. Pzas. Pcs.	Ship Ctn. Pzas. Pcs.	Std. Pkg. Pzas. Pcs.
					mm	inch	kg	Lb				
	TR-0424	01.02.0424	Tapa rectangular para contacto de 35.23 mm Ø 1 3/8". 4 diámetros. Single gang round receptacle cover 1 3/8" diameter hole. Box mount. 4 holes.	4	1.02	.040	2.1	4.6	10	50	200	400
	TR-0414	01.02.0414	Tapa rectangular para contacto de 40.38 mm Ø 1 9/16". 4 diámetros. Single gang round receptacle cover 1 9/16" diameter hole. Box mount. 4 holes.	4	1.02	.040	2.0	4.4	10	50	200	400
	TR-0426	01.02.0426	Tapa rectangular para contacto de 54.30 mm Ø 2 1/8". 4 diámetros. Single gang round receptacle cover 2 1/8" diameter hole. Box mount. 4 holes.	4	1.02	.040	1.7	3.7	10	50	200	400
	TR-0425	01.02.0425	Tapa rectangular para contacto de 35.23 mm Ø 1 3/8". 2 diámetros. Single gang round receptacle cover 1 3/8" diameter hole. Device mount. 2 holes	2	1.02	.040	2.1	4.6	10	50	200	400
	TR-0423	01.02.0423	Tapa rectangular para contacto de 40.38 mm Ø 1 9/16". 2 diámetros. Single gang round receptacle cover 1 9/16" diameter hole. Device mount. 2 holes.	2	1.02	.040	2.0	4.4	10	50	200	400
	TR-0427	01.02.0427	Tapa rectangular para contacto de 54.30 mm Ø 2 1/8". 2 diámetros. Single gang round receptacle cover 2 1/8" diameter hole. Device mount. 2 holes.	2	1.02	.040	1.8	4.0	10	50	200	400
	TR-0415	01.02.0415	Tapa rectangular para interruptor. 4 diámetros. Single gang toggle switch cover. Box mount. 4 holes.	4	1.02	.040	2.3	5.1	10	50	200	400
	TR-0421	01.02.0421	Tapa rectangular para interruptor. 2 diámetros. Single gang toggle switch cover. Device mount. 2 holes.	2	1.02	.040	2.3	5.1	10	50	200	400

Especificaciones sujetas a cambio sin previo aviso. Specifications are subject to change without notice..

RAWELT, S.A. de C.V.

RAWELT® INYECTADOS
Una División del Grupo REVUELTA

**3.1 - CAJA RECTANGULAR. A PRUEBA DE INTEMPERIE. SERIE RR.
TAPA RECTANGULAR. ALUMINIO.**

**3.1 - WEATHERPROOF SINGLE GANG BOX. RR SERIES.
SINGLE GANG COVER. ALUMINUM.**

Hoja: 4 / 7
Page:

FICHA TECNICA / TECHNICAL DATA

007-RW-154

USAR No. DE CODIGO PARA HACER PEDIDOS / TO ORDER USE CODE NUMBER

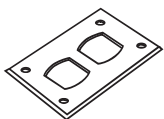
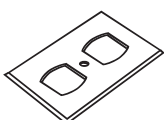
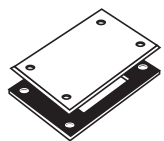
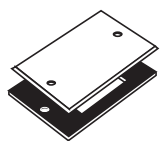
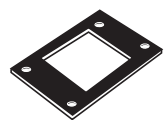
Figura Figure	Catalogo Catalog	Codigo Code	Descripción Description	Cant. Diam. Qty.	Espesor Thickness		Peso x 100 pzas. Weight x 100 pcs.		Pqt. Unit Pzas. Pcs.	Unit Ctn. Pzas. Pcs.	Ship Ctn. Pzas. Pcs.	Std. Pkg. Pzas. Pcs.
					mm	inch	kg	Lb				
	TR-0385	01.02.0385	Tapa rectangular para contacto duplex. 4 diámetros Single gang duplex receptacle cover. Box mount. 4 holes.	4	1.02	.040	2.0	4.4	10	50	200	400
	TR-0422	01.02.0422	Tapa rectangular para contacto duplex. 1 diámetro. Single gang duplex receptacle cover. Device mount. 1 hole.	1	1.02	.040	1.9	4.2	10	50	200	400
	TR-0416	01.02.1309.G	Tapa rectangular ciega con empaque. 4 diámetros. Weatherproof single gang blank cover. Box mount with gasket. 4 holes.	4	1.02	.040	2.4	5.3	10	40	160	330
	ERP-0614											
	TR-0420	01.02.1310.G	Tapa rectangular ciega con empaque. 2 diámetros. Weatherproof single gang blank cover. Device mount with gasket. 2 holes.	2	1.02	.040	2.4	5.3	10	40	160	330
	ERP-0614											
	ERP-0614	01.05.0614	Empaque de PVC tipo rectangular. PVC gasket.	4	3.17	1/8	1.0	2.2	10	100	700	

TAPONES / PLUGS

USAR No. DE CODIGO PARA HACER PEDIDOS / TO ORDER USE CODE NUMBER

Figura Figure	Catalogo Catalog	Codigo Code	Descripción Description	Medida nominal Hub size		Peso x 100 pzas. Weight x 100 pcs.		Pqt. Unit Pzas. Pcs.	Unit Ctn. Pzas. Pcs.	Ship Ctn. Pzas. Pcs.	Std. Pkg. Pzas. Pcs.
				mm	inch	kg	Lb				
	TA-0371	01.04.0371	Tapón roscado. Close-up plug.	12.7	1/2	1.0	2.2	25	200	2000	
	TA-0368	01.04.0368		19.0	3/4	1.3	2.9	25	100	1000	
	TA-2632	01.04.2632		25.4	1	1.7	3.7	25	100	1000	

Certificaciones / Compliances:  Expediente/File No. LR 105795-1

 Expediente/File No. E135600

 Tapones
Closure plugs

Especificaciones sujetas a cambio sin previo aviso. Specifications are subject to change without notice.

RAWELT, S.A. de C.V.

RAWELT ® INYECTADOS
Una División del Grupo **REVUELTA** 

3.1 - CAJA RECTANGULAR. A PRUEBA DE INTEMPERIE. SERIE RR.

Hoja: 5 / 7
Page:

FICHA TECNICA / TECHNICAL DATA

3.1 - WEATHERPROOF SINGLE GANG BOX. RR SERIES.

007-RW-154



TAPA

- Material: Aluminio inyectado a presión (diecast).
- Acabados: Pintura electrostática epoxica/poliéster polimerizada.
- Para uso en interiores y exteriores.
- Provee protección contra la intemperie cuando el receptáculo no está en uso.
- Empaque y tornillos galvanizados incluidos.
- Contratapa con mecanismo de auto-cierre.

COVER

- Diecast aluminum.
- Finish: Electrostatic powder epoxy/poliéster coating.
- For use indoors and outdoors.
- Provides weatherproof protection when the receptacle is not in use.
- Gasket and galvanized mounting screws included.
- Self-closing cover.

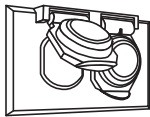
USAR No. DE CODIGO PARA HACER PEDIDOS / TO ORDER USE CODE NUMBER

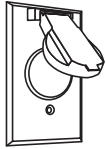
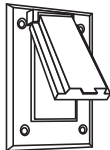
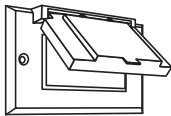
Figura Figure	Catalogo Catalog	Codigo Code	Descripción Description	Cant. Diam. Qty.	Peso x 100 pzas. Weight x 100 pcs.		Pqt. Unit Pzas. Pcs.	Unit Ctn. Pzas. Pcs.	Ship Ctn. Pzas. Pcs.	Std Pkg. Pzas. Pcs.
					kg	Lb				
	TR-0611	01.03.0611	Tapa rectangular a prueba de intemperie para contacto duplex horizontal. Weatherproof single gang horizontal cover for duplex receptacles.	1	16.0	35.0	1	12	48	96
	TR-0567	01.03.0567	Tapa rectangular a prueba de intemperie para contacto duplex vertical. Weatherproof single gang vertical cover for duplex receptacles.	1	13.0	29.0	1	12	48	96
	TR-0563	01.03.0563	Tapa rectangular a prueba de intemperie para contacto de 37.5 mm (1.47"). Weatherproof single gang round receptacle cover with 1.47" diameter hole.	2	13.0	29.0	1	12	48	96
	TR-0565	01.03.0565	Tapa rectangular a prueba de intemperie para contacto GFCI vertical. Weatherproof single gang vertical cover for GFCI receptacles.	4	14.0	31.0	1	12	48	96
	TR-3251	01.03.3251	Tapa rectangular a prueba de intemperie para contacto GFCI horizontal. Weatherproof single gang horizontal cover for GFCI receptacles.	2	15.5	34.0	1	12	48	96

Especificaciones sujetas a cambio sin previo aviso. Specifications are subject to change without notice.

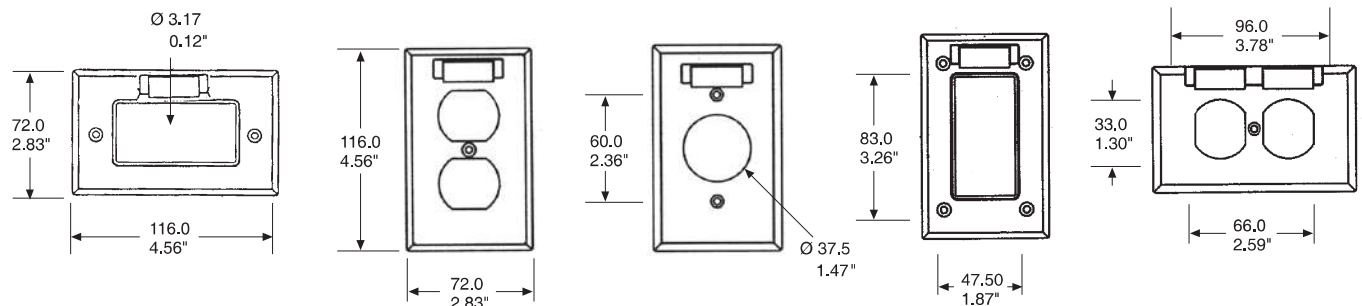

Dimensiones en milímetros y pulgadas. Dimensions in millimeters and inches.

RAWELT, S.A. de C.V.

RAWELT INYECTADOS
Una División del Grupo REVUELTA

16- II - 2016