

## ENS-RGBO42U8

### Standard:

Comply with ANSI/EIA RS-310-D,  
IEC60297-2,  
DIN41494;PART1;  
DIN41494;PART7

### Material:

SPCC Cold Rolled Steel;  
19" rails: 2.0mm, others: 1.2mm

### Loading capacity:

Static loading: 1000KG

### Feature:

- *Welded frame.*
- Fixed with the plinth.
- The plinth is also for cable entry & air vented, The bottom is with the brush cable entry hole.
- The front door & rear door is with sealed strip with three-point lock. The door opening angle greater than 120 degrees. Whole sealed side panel.
- The top could be fixed with fan unit if needed.
- IP rate:55

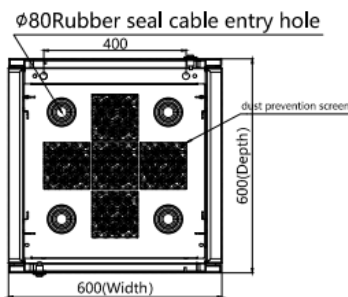
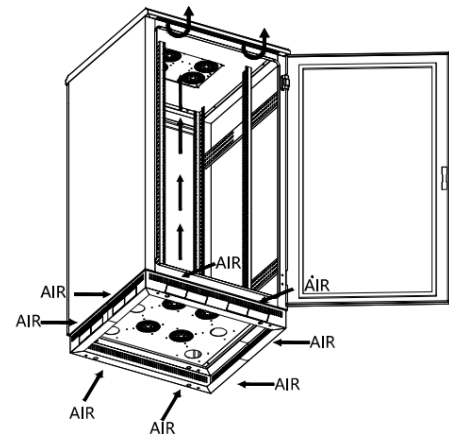
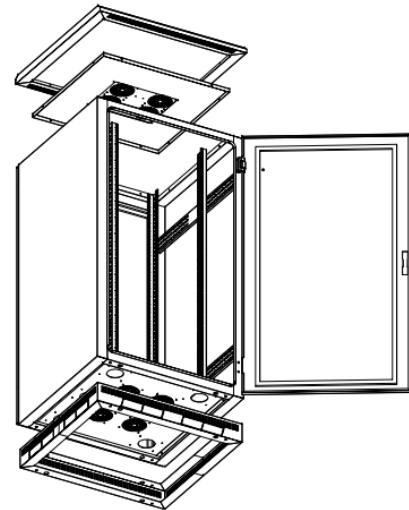

A-A SECTION

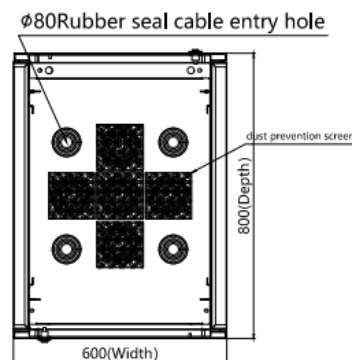

A-A SECTION

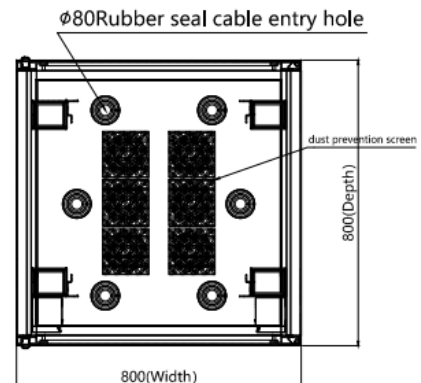

A-A SECTION

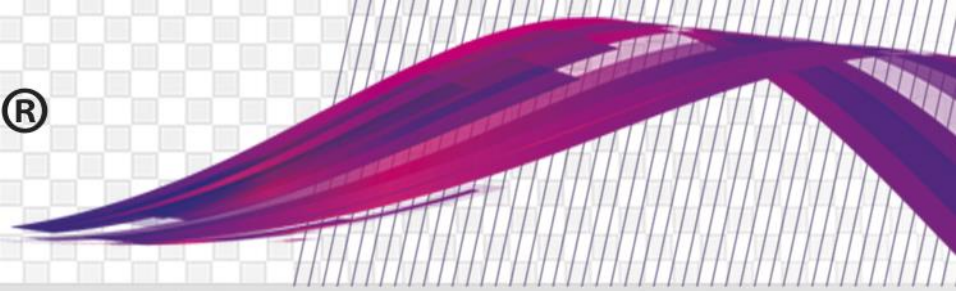

## ENS-RGB042U8

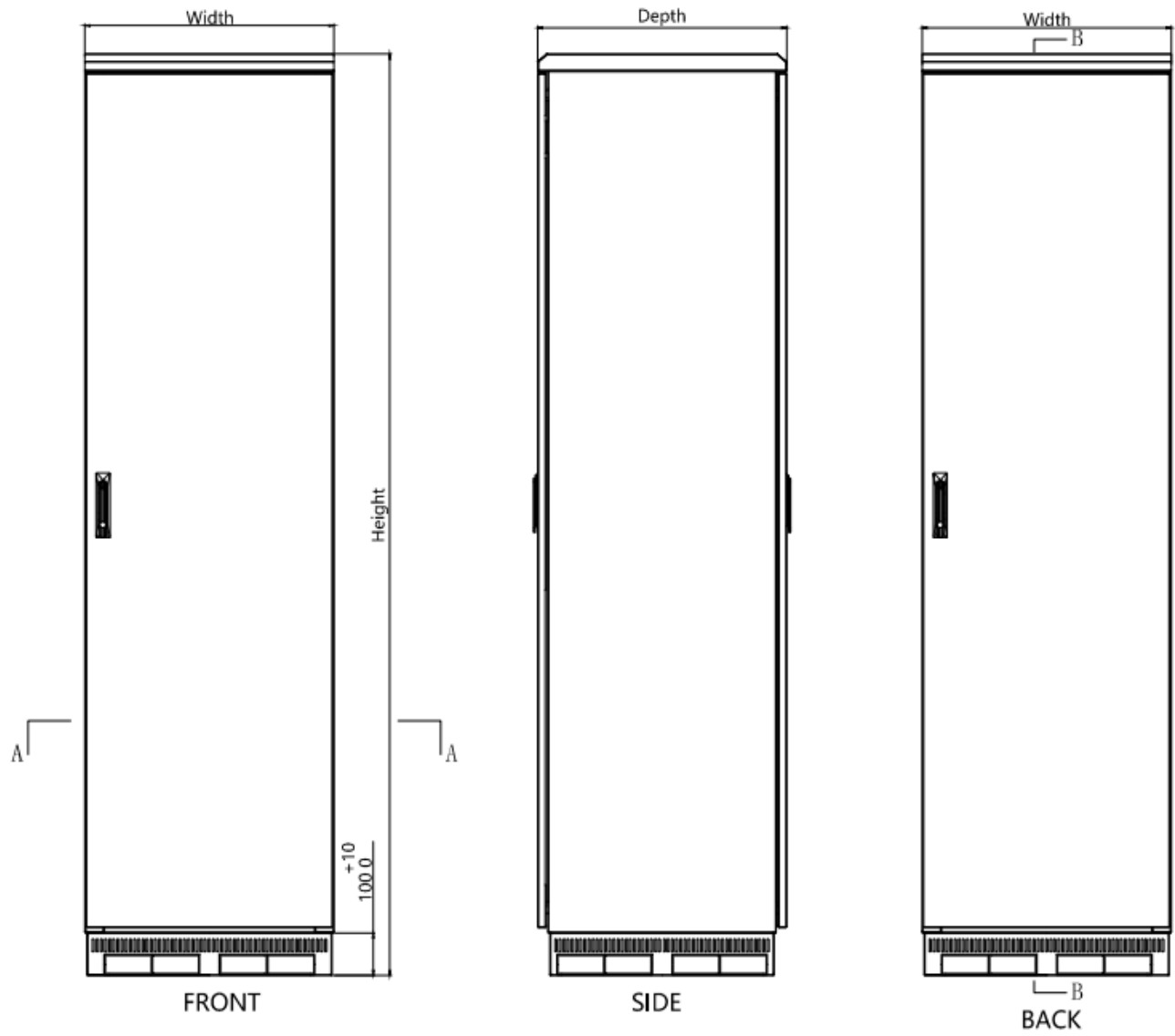

## ENS-RGB042U8

