

GV-TFD4800 AI 4MP H.265 Super Low Lux WDR Pro IR Mini Fixed IP

Dome



- AI deep learning: AI Perimeter Protection & Classification (Human & Vehicle)
- 1/2.7" progressive scan CMOS
- Min. illumination at 0.003 lux
- Triple streams from H.265, H.264 and MJPEG
- Up to 30 fps at 2688 x 1520
- Intelligent IR
- Day and Night function (with removable IR-cut filter)
- Wide Dynamic Range Pro (WDR Pro)
- IR distance up to 30 m (100 ft)
- Built-in micro SD card slot (SD / SDHC / SDXC / UHS-I, Class 10) for local storage
- 3-axis mechanism (pan / tilt / rotate)
- Two-way audio capable
- One sensor input and one alarm output
- DC 12V / PoE (IEEE 802.3af)
- Pigtail-Free
- Built-in microphone
- Defog
- 3D noise reduction
- Motion detection
- Text overlay
- Privacy mask
- Tampering Alarm
- Smart phone app support
- 12 languages supported
- ONVIF (Profile G, S, T) conformant

Introduction

GV-TFD4800 is an indoor, fixed, network camera equipped with an automatic IR-cut filter and an IR LED for day and night surveillance. The camera supports H.265 video codec to achieve better compression ratio while maintaining high quality pictures at reduced network bandwidths. With the super low lux CMOS image sensor, the camera is capable of providing a color live view in near darkness.

Empowered by deep learning algorithms, AI technology distinguishes human and vehicles from other moving objects. Integrated with GeoVision Video Management Software (VMS), it supports AI perimeter protection, real-time alert, playback and more.

Deep Learning Function Face Detection



AI Perimeter Protection (Intrusion, Crossing Line Entering Area, Leaving Area)

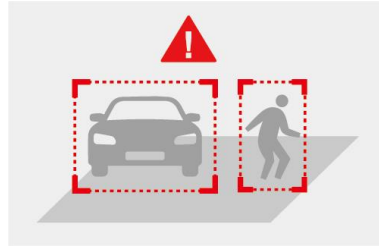

People Counting



Note: People Flow Counting and Crowd Density Monitoring integration of the camera to GV-VMS is coming soon.

Dimensions

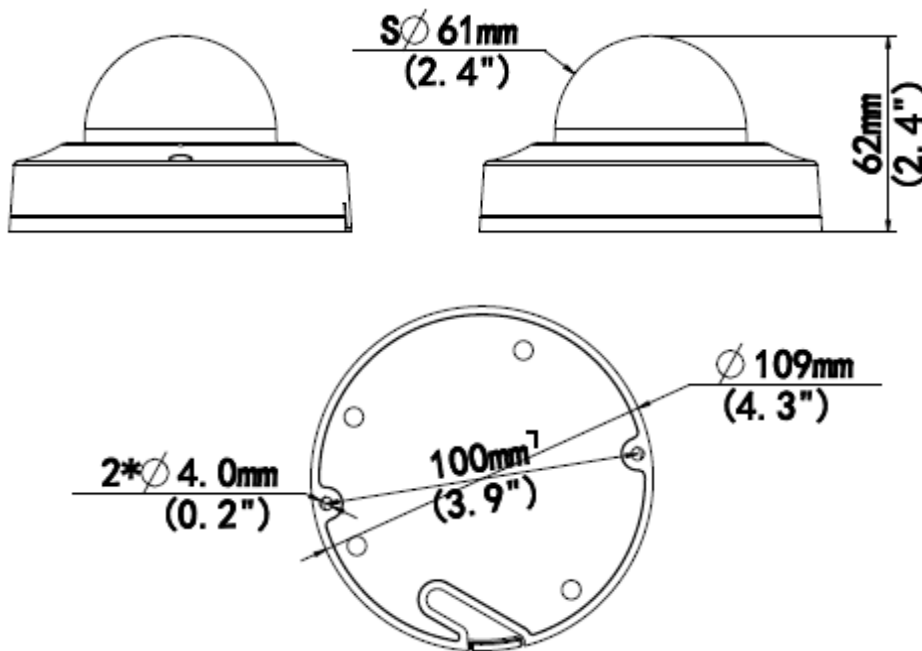

Specifications

Camera		
Image Sensor	1/2.7" progressive scan CMOS	
Picture Elements	2688 (H) x 1520 (V)	
Minimum Illumination	Color	0.003Lux (F1.6, AGC ON)
	IR On	0 Lux
Shutter Speed	Auto / Manual (1 ~ 1/100000 sec)	
White Balance	Auto / Manual	
Gain Control	Auto / Manual	
S/N Ratio	52 dB	
WDR Pro	Yes	
Dynamic Range	120 dB	
Lens		
Megapixel	Yes	
Day/Night	Yes (with removable IR-cut filter)	
Focal Length	2.8 mm	
Lens Type	Fixed	
Maximum Aperture	F/1.6	
Mount	M12	

Horizontal FOV		101.1°
Operation	Focus	Fixed
	Zoom	Fixed
	Iris	Fixed
IR LED Quantity		1 IR LED
Max. IR Distance		30 m (100 ft)
Operation		
Video Compression		H.265, H.264, MJPEG
Video Streaming		Triple streams from H.265, H.264 or MJPEG
Video Resolution	Main Stream	2688 x 1520 (Default), 2560 x 1440, 2304 x 1296, 1920 x 1080, 1280 x 720
	Sub Stream	1280 x 720, 720 x 576, 640 x 480, 640 x 360 (Default)
	Third Stream (Closed by Default)	720 x 576, 704 x 288, 640 x 360, 352 x 288
Frame Rate		30 fps at 2688 x 1520, 30 fps at 2560 x 1440, 30 fps at 2304 x 1296, 30 fps at 1920x 1080 (60 / 50 Hz) * The frame rate and performance may vary depending on the number of connections and data bitrates (different scenes).
Video Analytics		Motion Detection, Tampering Alarm, Audio Detection *Tampering alarm and audio detection are only accessible through the camera's Web interface, which can be used to trigger alerts such as e-mail and FTP
Image Setting		Brightness, Contrast, Saturation, Sharpness, Flicker-less, 3D Noise Reduction, Image Orientation (Flip, Mirror, 0°, 90°, 180°, 270°-including Corridor format), Exposure Mode, Shutter Speed, Gain Control, Slow Shutter, Metering Control, D/N Sensitivity, WDR, Smart Illumination, White Balance, Defog
Audio Compression		G.711
Audio Support		Two-way audio (external speaker required)
Digital I/O	Input	1 Input, dry contact, NO / NC
	Output	1 Relay Output (1A 30V DC / 0.3A 125V AC)
Network		
Interface		10 /100 Ethernet
Protocol		802.1x , ARP, DHCP, DDNS, DNS, FTP, HTTP, HTTPS, ICMP, IGMP, IPv4, IPv6, NTP, PPPoE, QoS, RTCP, RTP, RTSP, SMTP, SNMP, TCP, UDP, UPnP, ONVIF (Profile G, S, T)
Deep Learning Function		
AI Analytics		Intrusion, Cross Line, Enter Area, Face Detection, Leave Area (Human & Vehicle classification), People Flow Counting, Crowd Density Monitoring
Mechanical		
Camera Angle Adjustment	Pan	0° ~ 348°
	Tilt	-66° ~ 66°
	Rotate	0°~ 346°
Connectors	Power	Terminal block (DC 12 V, 1.25 A), PoE
	Ethernet	RJ-45 connector
	Audio	1 In (built-in microphone or terminal block), 1 out (terminal block)
	Digital I/O	Terminal block
	Local Storage	Micro SD card slot (SD / SDHC / SDXC / UHS-I, Class 10) * UHS-II card type is not supported.
General		
Operating Temperature		-30° ~ 55°C (-22° ~ 131°F)
Humidity		0 ~ 95% (no condensation)
Power Source		12 V DC / PoE (IEEE802.3af)
Max. Power Consumption		4.5 W
Dimensions		∅ 109 x 62 mm (∅ 4.3" x 2.4")
Weight		0.22 kg (0.49 lb)
Certification		CE, FCC, LVD, RoHS, UL compliant
Web Interface		
Installation Management		Web-based configuration
Maintenance		Firmware upgrade through Web Browser or GV-IP Device Utility
Access from Web Browser		Live View, Video Recording, Change Video Quality, Bandwidth Control, Image Snapshot, Text Overlay, Image Masking

Language	Czech, English, French, German, Hungarian, Italian, Japanese, Polish, Portuguese, Russian, Spanish, Traditional Chinese
Software Applications	
Software Supported	GV-DVR / NVR (V8.9.1), GV-VMS (V17.4.5 / V18.3.0), GV-Control Center (V3.8.0 / V4.0.1), GV-Edge Recording Manager Windows Version (V2.2.0), GV-Recording Server / Video Gateway (V2.0.2), GV-Redundant / Failover Server (V1.2.0), GV-Mobile Server (V1.5.1), GV-AI Guard (V1.0.0)
Smart Device Access	GV-Eye for iOS and Android
Live Viewing	Browser (IE, Edge, Chrome, Firefox, Safari), Mobile APP







Note:



1. It is required to apply patch files to some of the supported software.
2. Do not use clothes or any ordinary material to clean the camera cover since they may result in scratches.
3. Specifications are subject to change without notice.

Packing List

- | | |
|--------------------------|-------------------|
| 1. GV-TFD4800 Fixed Dome | 4. Torx Wrench |
| 2. Screw Kit | 5. Download Guide |
| 3. Drill Template Paster | |

Accessories

Model No.	Name		Details
GV-Mount107 (must be used with GV-Mount 213)	Pendant Bracket		Dimensions: Ø 120 x 334 mm (Ø 4.72" x 13.15") Weight: 0.74 kg (1.63 lb)
GV-Mount211P	Wall Mount and Junction Box		Dimensions: Ø 233 x 125 x 125 mm / (Ø 9.2" x 4.9" x 4.9") Weight: 1 kg (2.2 lb)
GV-Mount213	Wall Box Mount		Dimensions: Ø 109 x 39 mm (Ø 4.3" x 1.5") Weight: 0.2 kg (0.44 lb)
GV-Mount300-2	Convex Corner Mount		Dimensions: 137 x 233 x 160 mm (5.4" x 9.17" x 6.3") Weight: 1.65 kg (3.64 lb)
GV-Mount310-2	Concave Corner Mount		Dimensions: 111.2 x 369.9 x 210 mm (2.6" x 11.4" x 6.6") Weight: 1.65 kg (3.64 lb)
GV-Mount420 (must be used with GV-Mount211P)	Pole Mount Bracket		Dimensions: Ø 120 x 120 x 53.4 mm (Ø 4.7" x 4.7" x 2.1") Steel Strap Diameter: Ø 67 ~ 127 mm (Ø 2.6" ~ 5") Weight: 0.45 kg (0.99 lb)

GV-Mount704 (must be used with GV-Mount107)	Extension Tube		<p>Dimensions: Ø 3.5 x 10 or 20 or 30 or 50 cm (Ø 1.38" x 3.9" or 7.9" or 11.8" or 19.7")</p> <p>Weight: 225 g or 360 g or 500 g or 780g (0.5 lb or 0.79 lb or 1.1 lb or 1.72 lb)</p>
GV-PA191	Power over Ethernet (PoE) Adapter		<p>GV-PA191 is a Power over Ethernet (PoE) adapter designed to provide power to the IP device through a single Ethernet cable.</p>
GV-POE Switch	<p>GV-POE Switch is designed to provide power along with network connection for IP devices. The GV-POE Switch is available in various models with different numbers and types of ports.</p>		
Power Adapter	<p>Contact our sales representatives for the countries and areas supported.</p>		