

# THORSMAN®

by *thorsmex*  
group

## LÍNEA DE FIJACIÓN



### SISTEMA DE FIJACIÓN PARA PANEL DE YESO

#### Descripción

- Taquetes para fijar y sujetar objetos en muros falsos como panel de yeso, mampostería y tabique hueco
- Para uso en interiores
- Flexible
- Resistente al impacto
- Fácil de instalar

#### Propiedades del Producto

- COLOR:
  - TMM: natural
  - Perforathores: blanco
  - Clavithores: blanco y amarillo
  - Fijathor TSP: blanco, azul
  - Clavo: natural
- TEMPERATURAS DE OPERACIÓN
  - Nylon con fibra -40°C a 80°C (-40°F a 176°F)
  - Nylon sin fibra -40°C a 80°C (-40°F a 176°F)
  - Poliestireno: - 50°C a 80°C (-58°F a 176°F)
  - Polietileno -50°C a 80°C (-58°F a 176°F)
  - Acero Galvanizado: -20°C a + 80°C (-4°F a 176°F)

#### Solución/Mercado



#### Materia Prima

- Perforathores: nylon n° 6 fibra de vidrio
- TMM: pa nylon
- Clavithores: poliestireno de alto impacto
- Fijathor tsp: polietileno de alta densidad, clavo: acero galvanizado
- TMTY: acero al carbono, chapado en zinc amarillo



	PERFORATHOR TPD	FIJATHOR TSP	CLAVITHOR	FIJATHOR TMM	TAQUETE /WALL PLUG /CHEVILLES A EXPANSION TMTY
<b>CARGA RECOMENDADA</b> RECOMMENDED LOAD CHARGE RECOMMANDÉE	5 kg (11.02 lb)	20 kg (44.09 lb)	5 kg (11.02 lb) / 8 kg (17.63 lb)	20 kg (44.1 lb)	30 kg (66.14 lb)
<b>BROCA RECOMENDADA</b> RECOMMENDED DRILL BIT FORÊT RECOMMANDÉE	N/A	3/8" (9.5 mm)	7/32" / 3/16" (5.5 mm / 4.7 mm)	5/16" (5.5 mm)	N/A
<b>CLAVO/TORNILLO RECOMENDADO</b> RECOMMENDED NAIL/SCREW CLOU/VIS RECOMMANDÉE(E)	10 x 1 1/2" (4.82 X 38.1 mm)	10/75 (10-32/76.2 mm)	1.9 X 3/4" (19.1 mm)/ 1.9 X 1" (25.4 mm)	8 x 2" (4.16 x 50.8 mm)	8 x 1 3/16" (4.16 x 30 mm)



ISO 9001-2015

**THORSMEX, S.A. DE C.V.**

Bld. Manuel Ávila Camacho 2900-701, Fracc. Los Pirules, Tlalnepantla,

Edo. de México, C.P.54040 • Tel: (55) 5379-67-47 Área comercial:

EXT 104, 105, 119, 120 y 128 • info@thorsmex.mx

www.thorsmex.mx



Clavithor TCP0

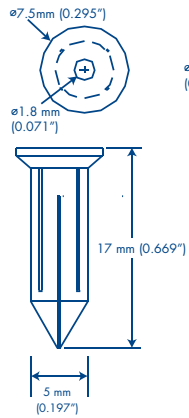

Clavithor TCP1

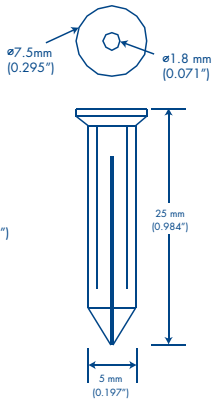

Fijathor TSP

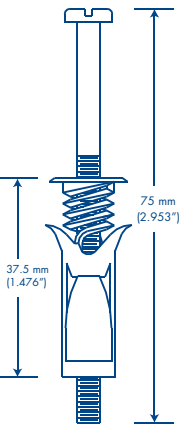

Fijathor TMM

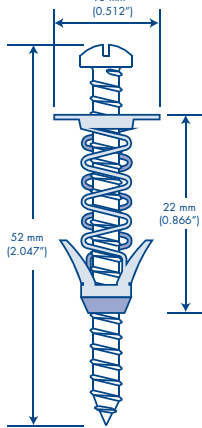

Perforathor TPD

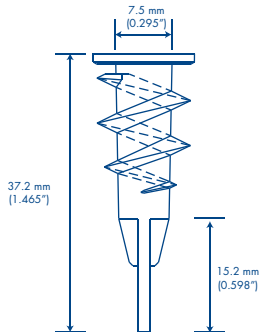

Descripción	Código	Código de Barras	Presentación	Dimensiones
Sistemat de Fijación para Panel de Yeso	3701-01000	7506218113011	Caja con 91 piezas	L 43 mm (1.692 in) x W 137 mm (5.393 in) x H 181 mm (7.125 in)

### APLICACIÓN



PERFORATHOR

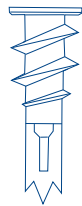

FIJATHOR



TCP0/TPC1



TMM



TMTY



### CONT: 91 PIEZAS

- 15 piezas de Perforathor TPD c/Pija 10x11/2" (4.82 x 38.1 mm)
- 3 piezas de Fijathor TSP 10/75 (10-32/76 mm)
- 30 piezas de Clavithor TCP0 c/clavo
- 30 piezas de Clavithor TCP1 c/clavo
- 8 piezas de Taquete Metálico TMTY para tabla yeso
- 5 piezas de Fijathor TMM

TMTY Taquete Metálico

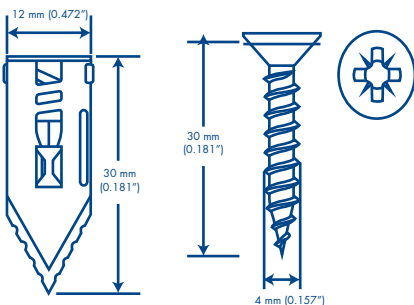

ISO 9001-2015