

L2+ Multi-Port Gigabit Stackable Managed Switch

SGS-5240-24T4X/SGS-5240-24P4X

SGS-5240-48T4X/SGS-5240-20S4C4XR

Quick Installation Guide

Table of Contents

1. Package Contents	3
2. Requirements	4
3. Switch Management.....	5
4. Terminal Setup	6
4.1 Logging on to the Console.....	7
4.2 Configuring IP Address.....	8
4.3 Setting 1000BASE-X for SFP+ Port.....	10
4.4 Saving the Configuration	10
5. Starting Web Management	11
5.1 Logging in to the Managed Switch from Management Port	12
5.2 Saving Configuration via the Web	13
6. Recovering Back to Default Configuration.....	14
7. Customer Support	16

1. Package Contents

Thank you for purchasing PLANET SGS-5240 L2+ Multi-Port Gigabit Stackable Managed Switch series. The descriptions of these models are as follows:

SGS-5240-24T4X	Layer 2+ 24-Port 10/100/1000T + 4-Port 10G SFP+ Stackable Managed Switch
SGS-5240-24P4X	Layer 2+ 24-Port 10/100/1000T 802.3at PoE + 4-Port 10G SFP+ Stackable Managed Switch
SGS-5240-48T4X	Layer 2+ 48-Port 10/100/1000T + 4-Port 10G SFP+ Stackable Managed Switch
SGS-5240-20S4C4XR	Layer 2+ 20-Port 100/1000X SFP + 4-Port Gigabit TP/SFP + 4-Port 10G SFP+ Stackable Managed Switch with Redundant Power

“**Managed Switch**” mentioned in this Quick Installation Guide refers to the above models.

Open the box of the **Managed Switch** and carefully unpack it. The box should contain the following items:

- The Managed Switch x 1
- Quick Installation Guide x 1
- RJ45-to-DB9 Console Cable x 1
- Power Cord x 1
- Rubber Feet x 4
- Two Rack-mounting Brackets with Attachment Screws x 1
- Grounding Cable x 1
- SFP Dust Cap

Model	SFP Dust Caps
SGS-5240-24T4X	4
SGS-5240-24P4X	4
SGS-5240-48T4X	4
SGS-5240-20S4C4XR	28

If any item is found missing or damaged, please contact your local reseller for replacement.

2. Requirements

- Workstations running Windows XP/2003/Vista/7/8/2008/10, MAC OS X or later, Linux, UNIX, or other platforms are compatible with TCP/IP protocols.
- Workstations are installed with Ethernet NIC (Network Interface Card)
- **Serial Port Connection (Terminal)**
 - The above Workstations come with **COM Port (DB9)** or **USB-to-RS232** converter.
 - The above Workstations have been installed with terminal emulator, such as Tera Term or PuTTY.
 - Serial cable -- one end is attached to the RS232 serial port, while the other end to the console port of the Managed Switch.
- **Ethernet Port Connection**
 - Network cables -- Use standard network (UTP) cables with RJ45 connectors.
 - The above PC is installed with Web browser.



Note

It is recommended to use Internet Explorer 8.0 or above to access the Managed Switch. If the Web interface of the Managed Switch is not accessible, please turn off the anti-virus software or firewall and then try it again.

3. Switch Management

To set up the Managed Switch, the user needs to configure the Managed Switch for network management. The Managed Switch provides two management options: **Out-of-Band Management** and **In-Band Management**.

■ Out-of-Band Management

Out-of-band management is the management through **Console interface**. **Generally, the user will use out-of-band management for the initial switch configuration**, or when in-band management is not available.

■ In-Band Management

In-band management refers to the management by logging in to the Managed Switch using **Telnet** or **HTTP**, or using **SNMP** management software to configure the Managed Switch. In-band management enables the management of the Managed Switch to attach some devices to the Switch. The following procedures are required to enable In-band management:

1. Logging on to console
2. Assigning/Configuring IP address
3. Creating a remote login account
4. Enabling HTTP or Telnet server on the Managed Switch

In case in-band management fails due to Managed Switch configuration changes, out-of-band management can be used for configuring and managing the Managed Switch.



Note

The Managed Switch is shipped with **Management Port** IP address **192.168.1.1/24** assigned and **VLAN 1 interface** IP address **192.168.0.100/24** assigned by default. User can assign another IP address to the Managed Switch via the Console interface to be able to remotely access the Managed Switch through Telnet or HTTP.

4. Terminal Setup

To configure the system, connect a serial cable to a **COM port** on a PC or notebook computer and to serial (console) port of the Managed Switch. The console port of the Managed Switch is DCE already, so that you can connect the console port directly through PC without the need of Null Modem.

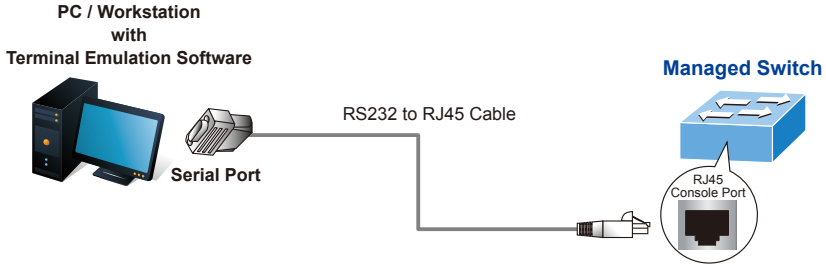

Figure 4-1: Managed Switch Console Connectivity

A terminal program is required to make the software connection to the Managed Switch. Tera Term program may be a good choice. The Tera Term can be accessed from the **Start** menu.

1. Click **START** menu, then **Programs**, and then **Tera Term**.
2. When the following screen appears, make sure that the COM port should be configured as:

- ◆ Baud: 115200
- ◆ Parity: None
- ◆ Data bits: 8
- ◆ Stop bits: 1
- ◆ Flow control: None

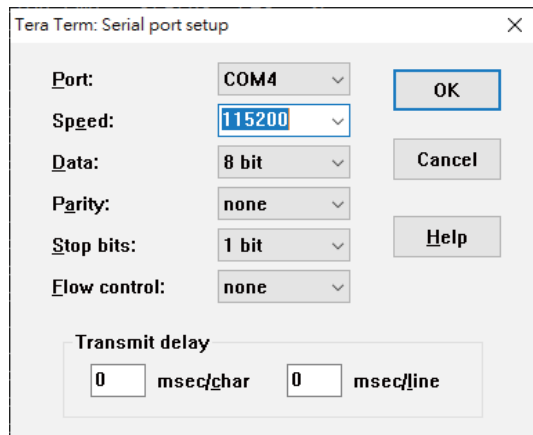

Figure 4-2: Tera Term COM Port Configuration

4.1 Logging on to the Console

Once the terminal is connected to the device, power on the Managed Switch, and the terminal will display “**running testing procedures**”.

Then, the following message asks for the login user name and password. The factory default user name and password are as follows as the login screen in Figure 4-3 appears.

```
Username: admin
Password: admin
```

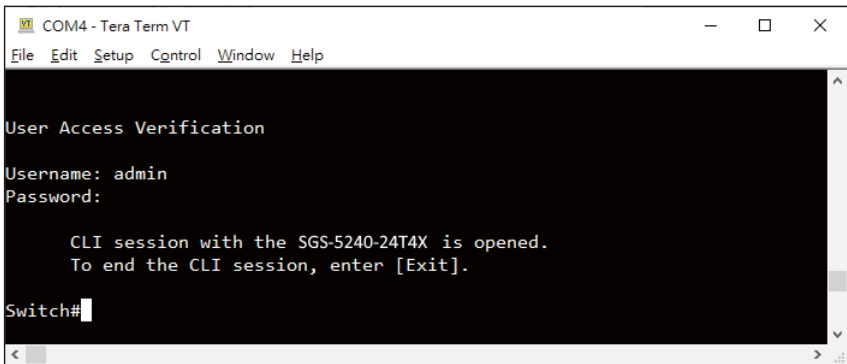

Figure 4-3: Managed Switch Console Login Screen

The user can now enter commands to manage the Managed Switch. For a detailed description of the commands, please refer to the following chapters.



Note

1. For security reason, **please change and memorize the new password after this first setup.**
2. Only accept command in lowercase letter under console interface.

4.2 Configuring IP Address

The IP address configuration commands for **VLAN1 interface** are listed below. Before using in-band management, the Managed Switch must be configured with an IP address by out-of-band management (i.e. console mode). The configuration commands are as follows:

```
Switch# config terminal  
Switch (config)# interface vlan 1  
Switch(config-if)# ip address 192.168.0.254 255.255.255.0
```

The previous command would apply the following settings for the Managed Switch.

IPv4 Address: 192.168.0.254
Subnet Mask: 255.255.255.0

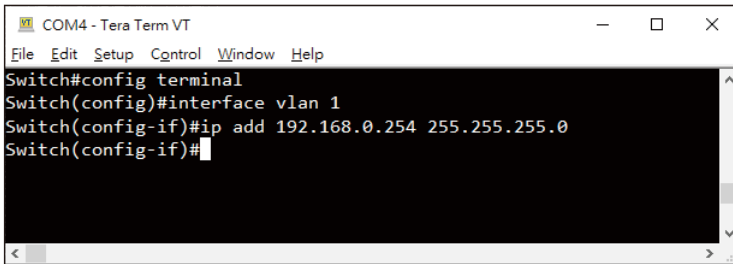
A screenshot of a terminal window titled "COM4 - Tera Term VT". The window has a menu bar with "File", "Edit", "Setup", "Control", "Window", and "Help". The terminal output shows the following commands and prompts:

```
Switch#config terminal  
Switch(config)#interface vlan 1  
Switch(config-if)#ip add 192.168.0.254 255.255.255.0  
Switch(config-if)#
```

The cursor is positioned at the end of the last line. The terminal has a black background with white text and a scroll bar on the right side.

Figure 4-4: Configuring IPv4 Address Screen

To check the current IP address or modify a new IP address for the Managed Switch, please use the procedure as follows:

■ Show the current IP address

1. On "**Switch#**" prompt, enter "**show ip interface vlan 1**".
2. The screen displays the current IP address, subnet mask and gateway as shown in Figure 4-5.

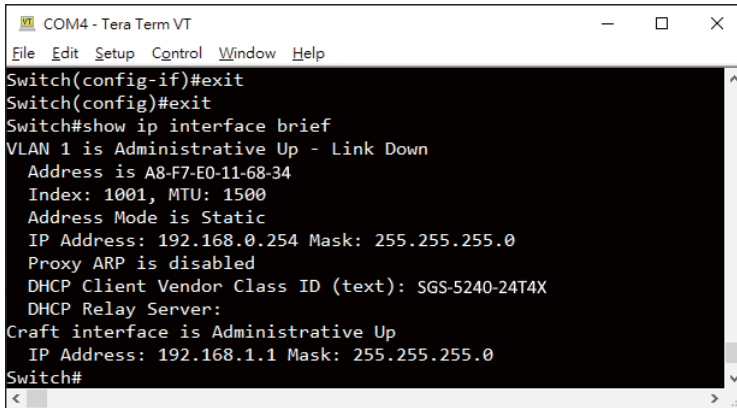

```
COM4 - Tera Term VT
File Edit Setup Control Window Help
Switch(config-if)#exit
Switch(config)#exit
Switch#show ip interface brief
VLAN 1 is Administrative Up - Link Down
  Address is A8-F7-E0-11-68-34
  Index: 1001, MTU: 1500
  Address Mode is Static
  IP Address: 192.168.0.254 Mask: 255.255.255.0
  Proxy ARP is disabled
  DHCP Client Vendor Class ID (text): SGS-5240-24T4X
  DHCP Relay Server:
Craft interface is Administrative Up
  IP Address: 192.168.1.1 Mask: 255.255.255.0
Switch#
```

Figure 4-5: Showing IP Information Screen

If the IP is successfully configured, the Managed Switch will apply the new IP address setting immediately. You can access the Web interface of Managed Switch through the new IP address.



Note

If you are not familiar with console command or the related parameter, enter "**?**" anytime in console to get the help description.

4.3 Setting 1000BASE-X for SFP+ Port

The Managed Switch supports both **1000BASE-X** and **10GBASE-X** SFP transceiver by manual setting and the default SFP+ port speed is set to 10Gbps.

For example, to establish the fiber connection with 1000BASE-X SFP transceiver in the **Ethernet 1/25**, the following command configuration is required:

```
Switch#config terminal
Switch(config)#interface ethernet 1/25
Switch(config-if)#speed-duplex 1000full
```

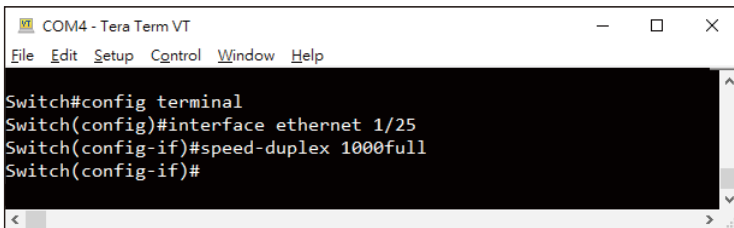

Figure 4-6: Setting 1000BASE-X Screen

4.4 Saving the Configuration

In Managed Switch, the running configuration file stores in the RAM. In the current version, the running configuration sequence running-config can be saved from the RAM to FLASH by **copy running-config startup-config** command, so that the running configuration sequence becomes the start-up configuration file, which is called configuration save.

```
Switch# copy running-config startup-config
Startup configuration file name: startup1.cfg
```

5. Starting Web Management

The Managed Switch provides a built-in browser interface. You can manage it remotely by having a remote host with Web browser, such as Microsoft Internet Explorer, Mozilla Firefox, Google Chrome or Apple Safari.

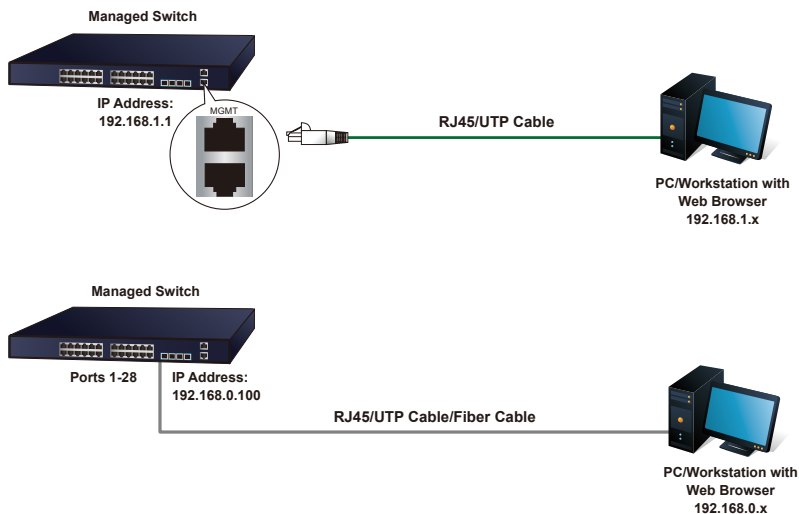

Figure 5-1: IP Management Diagram

The following shows how to start up the **Web Management** of the Managed Switch. Please note the Managed Switch is configured through an Ethernet connection. Please make sure the manager PC must be set to the same **IP subnet address**.

For example, the IP address of the Managed Switch is configured with **192.168.0.100** on **Interface VLAN 1** and **192.168.1.1** on **Management Port**, then the manager PC should be set to **192.168.0.x** or **192.168.1.x** (where x is a number between 1 and 254, except 1 or 100), and the default subnet mask is 255.255.255.0.

The factory default user name and password are as follows:

Default IP of Management Port: **192.168.1.1**
Default IP of Interface VLAN 1: **192.168.0.100**
Username: **admin**
Password: **admin**

5.1 Logging in to the Managed Switch from Management Port

1. Use Internet Explorer 8.0 or above Web browser and enter IP address **http://192.168.1.1** to access the Web interface.
2. When the following dialog box appears, please enter the configured username **"admin"** and password **"admin"** (or the username/password you have changed via console). The login screen in Figure 5-2 appears.

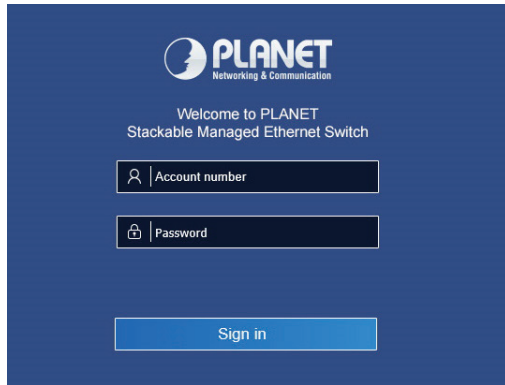

Figure 5-2: Login Screen

3. After entering the password, the main screen appears as shown in Figure 5-3.

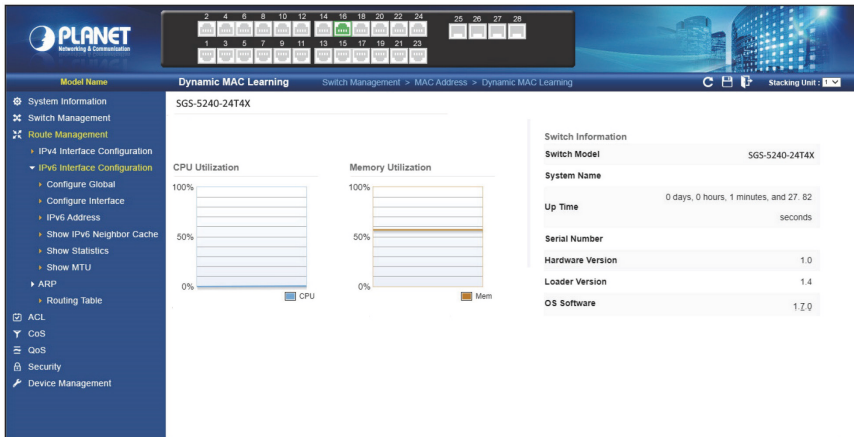

Figure 5-3: Web Main Screen of Managed Switch

4. The Switch Menu on the left of the Web page lets you access all the commands and statistics the Switch provides.

Now, you can use the Web management interface to continue the Switch management or manage the Managed Switch by console interface. Please refer to the user manual for more.

5.2 Saving Configuration via the Web

To save all applied changes and set the current configuration as a startup configuration, the startup-configuration file will be loaded automatically across a system reboot.

1. Click **"Device Management > File Management > Copy"** button to log in "Save current running-configuration" Page.

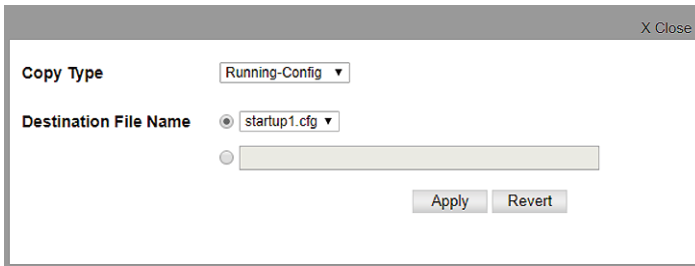

2. Press the **"Apply"** button to save current running-configuration to start up configuration.
3. Or you can press the **"Save Configuration"** button.



6. Recovering Back to Default Configuration

To reset the IP address to the default **VLAN 1 interface** IP address “**192.168.0.100**”, default **Management Port** IP address “**192.168.1.1**” or reset the login password to default value, press the hardware-based **reset button** on the rear panel for about **10 seconds**. After the device is rebooted, you can log in the management Web interface within the same subnet of 192.168.0.xx or 192.168.1.xx.

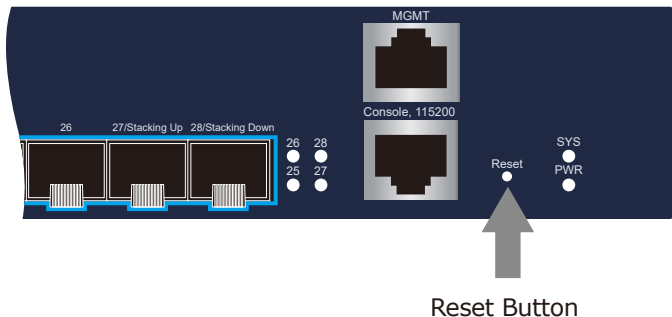

Figure 6-1: SGS-5240-24T4X/SGS-5240-24P4X Reset Button

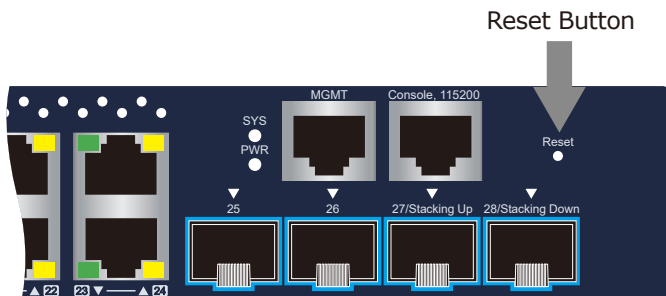

Figure 6-2: SGS-5240-20S4C4XR Reset Button

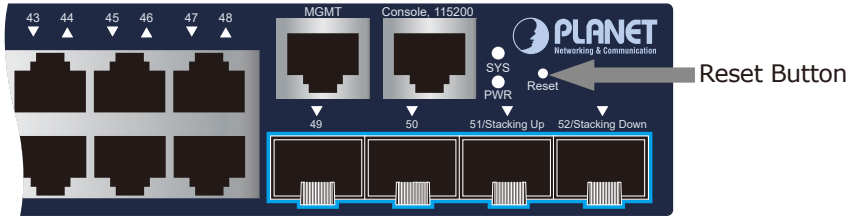

Figure 6-3: SGS-5240-48T4X Reset Button



Note

The SGS-5240-48T4X Reset Button only supports system reboot. You can use web GUI or command line to reset to default settings.

7. Customer Support

Thank you for purchasing PLANET products. You can browse our online FAQ resource at the PLANET Web site first to check if it could solve your issue. If you need more support information, please contact PLANET support team.

PLANET online FAQs:

<http://www.planet.com.tw/en/support/faq>

Support team mail address:

support@planet.com.tw

SGS-5240 Series User's Manual

<https://www.planet.com.tw/en/support/downloads?&method=keyword&keyword=SGS-5240&view=3#list>



(Please select your switch model name from the drop-down menu of Product Models.)

Copyright © PLANET Technology Corp. 2021.

Contents are subject to revision without prior notice.

PLANET is a registered trademark of PLANET Technology Corp.

All other trademarks belong to their respective owners.