

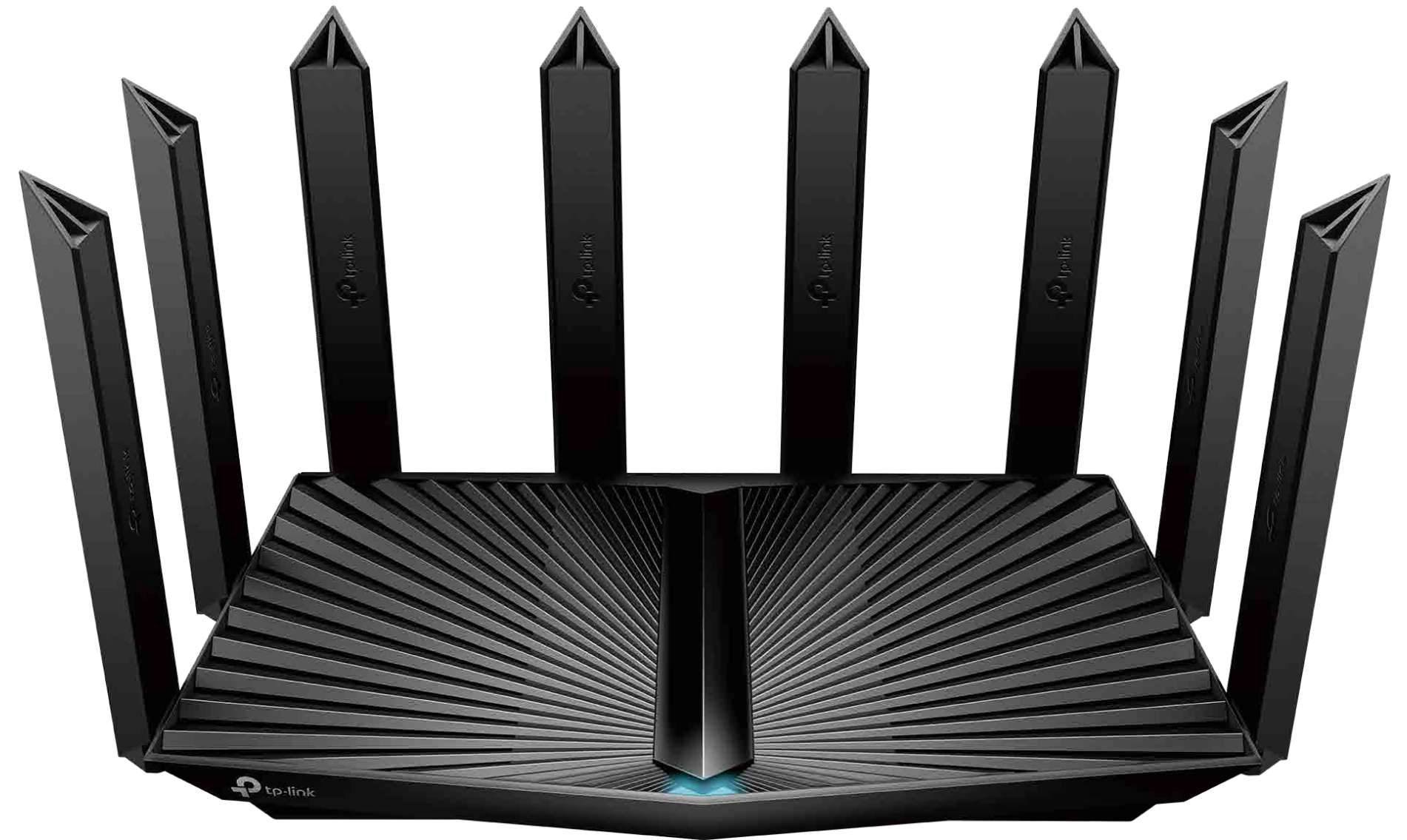

AX6600 Tri-Band Wi-Fi 6 Router

Explore the New Era of Wi-Fi



Archer AX90



AX6600
Tri-Band Speed



2.5 Gbps
Wired Connectivity



8 Streams
for More Devices



8 High-Performance
Antennas

Highlights

Wi-Fi 6 Faster. Broader. Unstoppable.

The Archer AX90, based on the next generation 802.11ax Wi-Fi technology, takes your Wi-Fi to the next level while being backwards compatible with 802.11a/b/g/n/ac Wi-Fi standards.



Unrivaled Tri-Band Speed

1024-QAM and HT160 boost overall speeds up to an incredible 6600 Mbps.*



8 Streams for More Devices

Eight Wi-Fi streams utilize OFDMA and MU-MIMO to bring more available bandwidth and less congestion for all devices.*



Save Smart Devices' Power

Target Wake Time schedules the connection time of battery-powered devices to reduce their power consumption.*



Backwards Compatible

Take your Wi-Fi to the next level while being backwards compatible with 802.11a/b/g/n/ac Wi-Fi standards.*

TP-Link HomeShield

TP-Link's premium security services keep your home network safe with cutting-edge features for network and IoT protection.*



Network Protection

Detect cyber threats to keep your privacy and connected devices well protected.



Quality of Service (QoS)

Prioritize your bandwidth needs to get a faster networking experience.



Parental Controls

Manage online time and block inappropriate content to keep families healthy online.



Comprehensive Reports

Gain full statistics and insights to help you know your home network better.

Highlights

Flexible Whole-Home Wi-Fi

OneMesh™ is a simple way to form a Mesh network with a single Wi-Fi name for seamless whole-home coverage. Connect a OneMesh™ range extender to Archer AX90 and never waste time searching for a stable connection again.

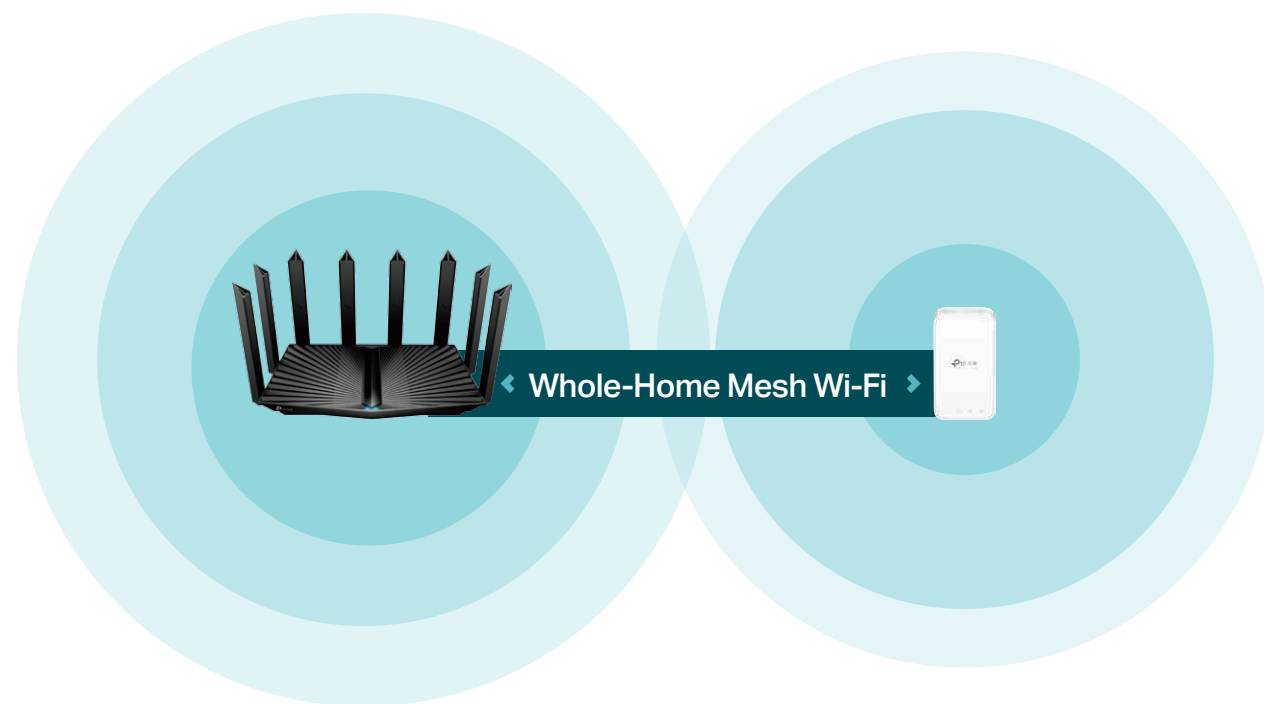

Superior Connectivity

Archer AX90's 2.5 Gbps and 1 Gbps WAN/LAN ports offer you maximum flexibility and boost your total internet throughput. Three gigabit LAN ports give you full control and blistering data transfer speeds for peak performance.*

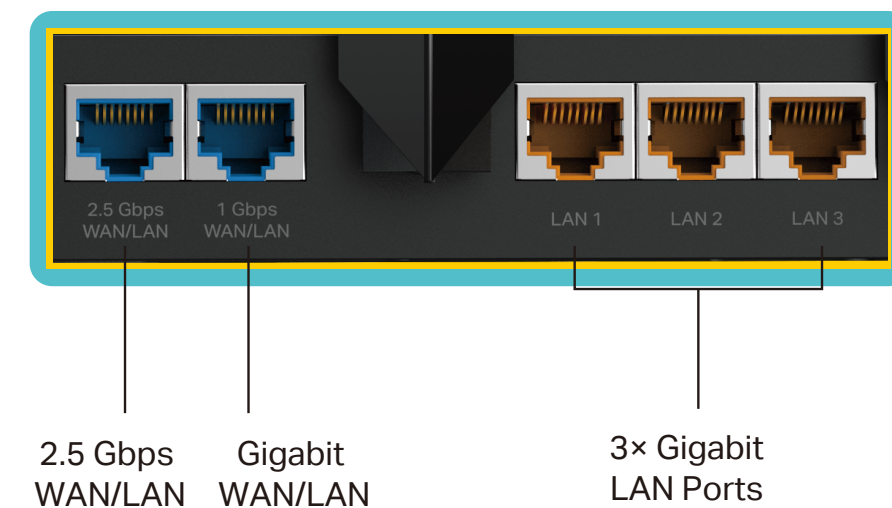

Features



Speed

- **Wi-Fi 6 Technology** – Wi-Fi 6 (802.11ax) features advanced technologies, including OFDMA, MU-MIMO, HT160, and 1024-QAM, drastically increasing the speed and efficiency of your entire network*
- **OFDMA** – Provides 4× greater capacity for more simultaneous connections*
- **Next-Gen Wireless Speed** – 4804 Mbps (5GHz) + 1201 Mbps (5GHz) + 574 Mbps (2.4GHz)

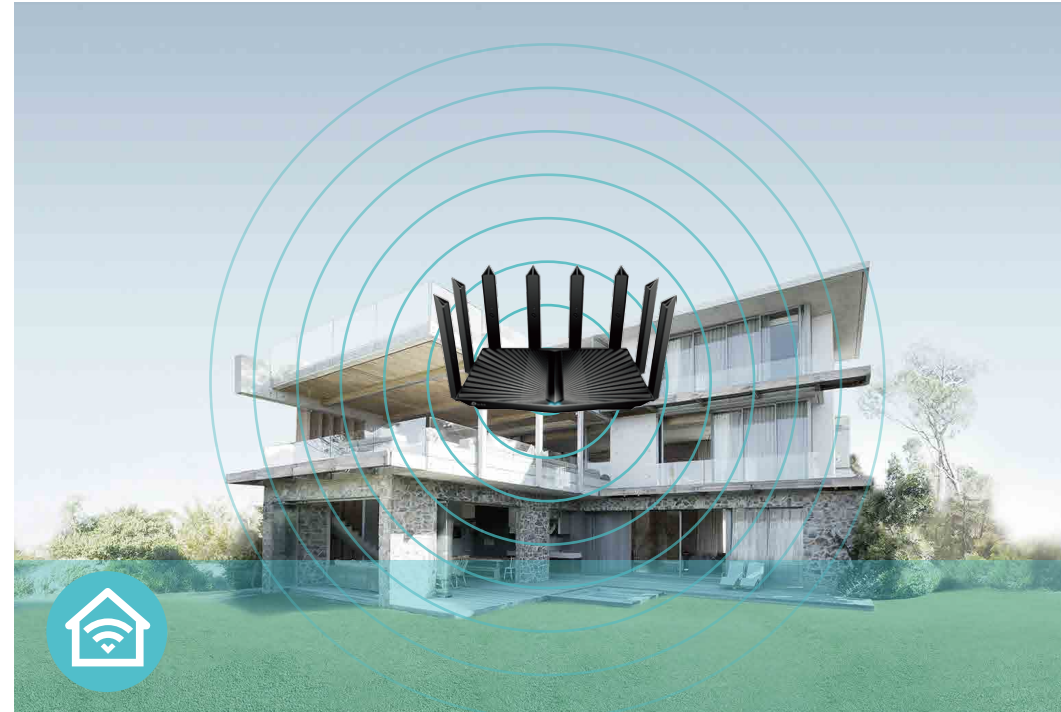

Wi-Fi Range

- **Ultimate Range Wi-Fi** – Eight high-gain external antennas deliver a Wi-Fi signal to every corner of your home, making all of your connections more efficient and stable
- **Beamforming Technology** – Concentrates Wi-Fi signals towards individual devices to ensure stronger connections



Reliability

- **Secure VPN Access** – Connects to a private network with a safe and secure OpenVPN and PPTP VPN connection
- **Airtime Fairness** – Balances bandwidth of connected devices to improve overall throughput and efficiency
- **Smart Connect** – Intelligently switches each device's connection to the optimum available Wi-Fi band

Features

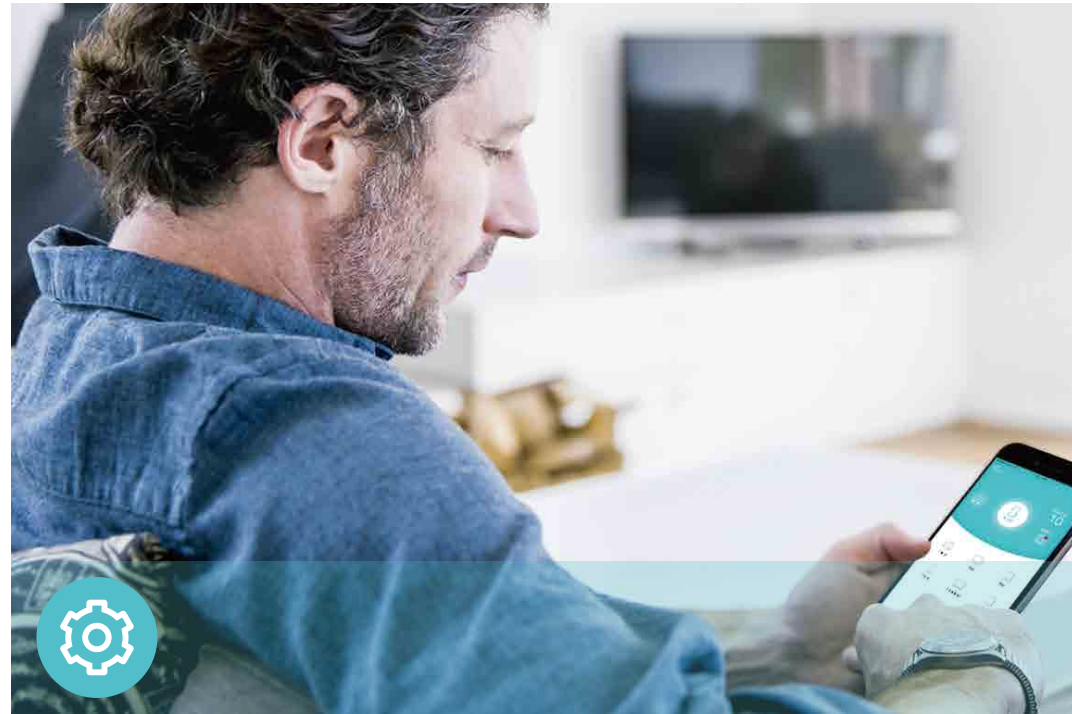

Ease of Use

- Intuitive Web UI – Ensures quick and simple installation without hassle
- Fast Encryption – One-touch WPA wireless security encryption with the WPS button
- Power On/Off – Conveniently power on or off your router as required
- Hassle-free Management with Tether App – Network management is made easy with the TP-Link Tether app, available on any Android and iOS device



Security

- Parental Controls – Manage when and how connected devices can access the internet
- Guest Network – Provides separate access for guests to secure the home network
- Access Control – Establishes a whitelist or blacklist to allow or restrict certain devices to access the internet
- Encryptions for Secure Network – WPA/WPA2-Personal, WPA2/WPA3-Personal, WPA/WPA2-Enterprise encryptions provide active protection against security threats

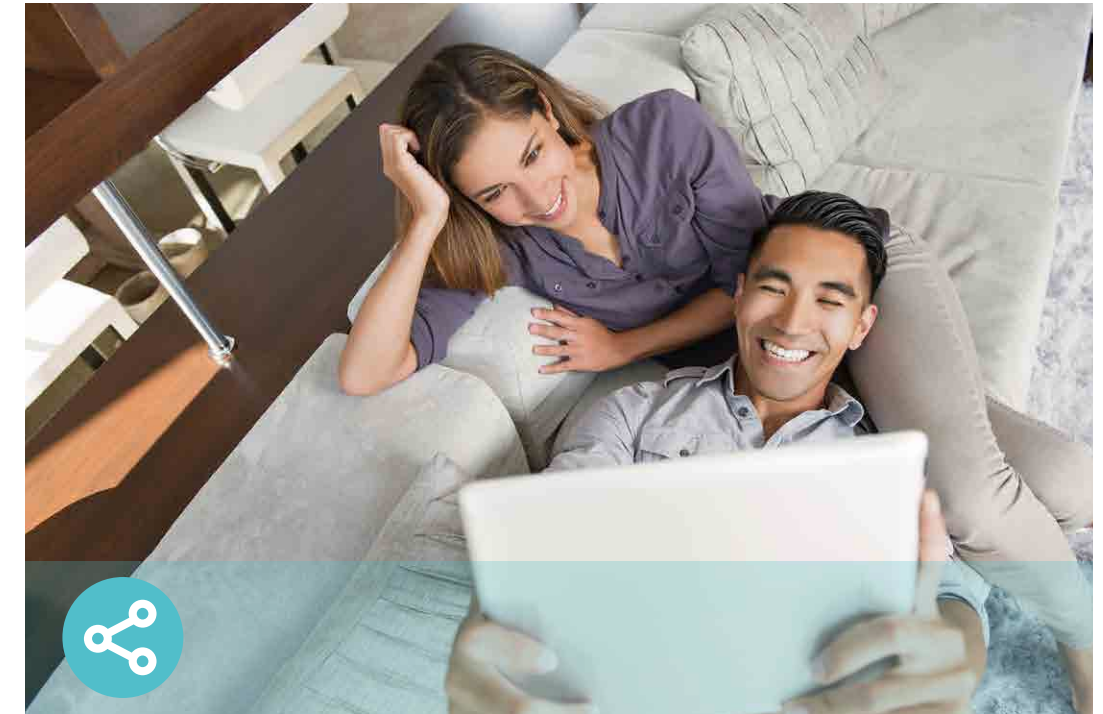

Easy Sharing

- USB Port – Connects external storage devices to rapidly share files, photos, and videos
- Built-in Media Server – Allows you to play music, watch videos and view photos from any device on your network

Specifications

Hardware

- Wireless: 4804 Mbps (5 GHz) + 1201 Mbps (5 GHz) + 574 Mbps (2.4 GHz)
- Antennas: 8× High-Performance Antennas
- Ethernet Ports: 1× 2.5 Gbps WAN/LAN Port + 1× Gigabit WAN/LAN Port + 3 × Gigabit LAN Ports
- USB Ports: 1× USB 3.0 Port + 1× USB 2.0 Port
- Dimensions: 12.2 × 8.1 × 6.8 in (310.9 × 206.9 × 173.7 mm)

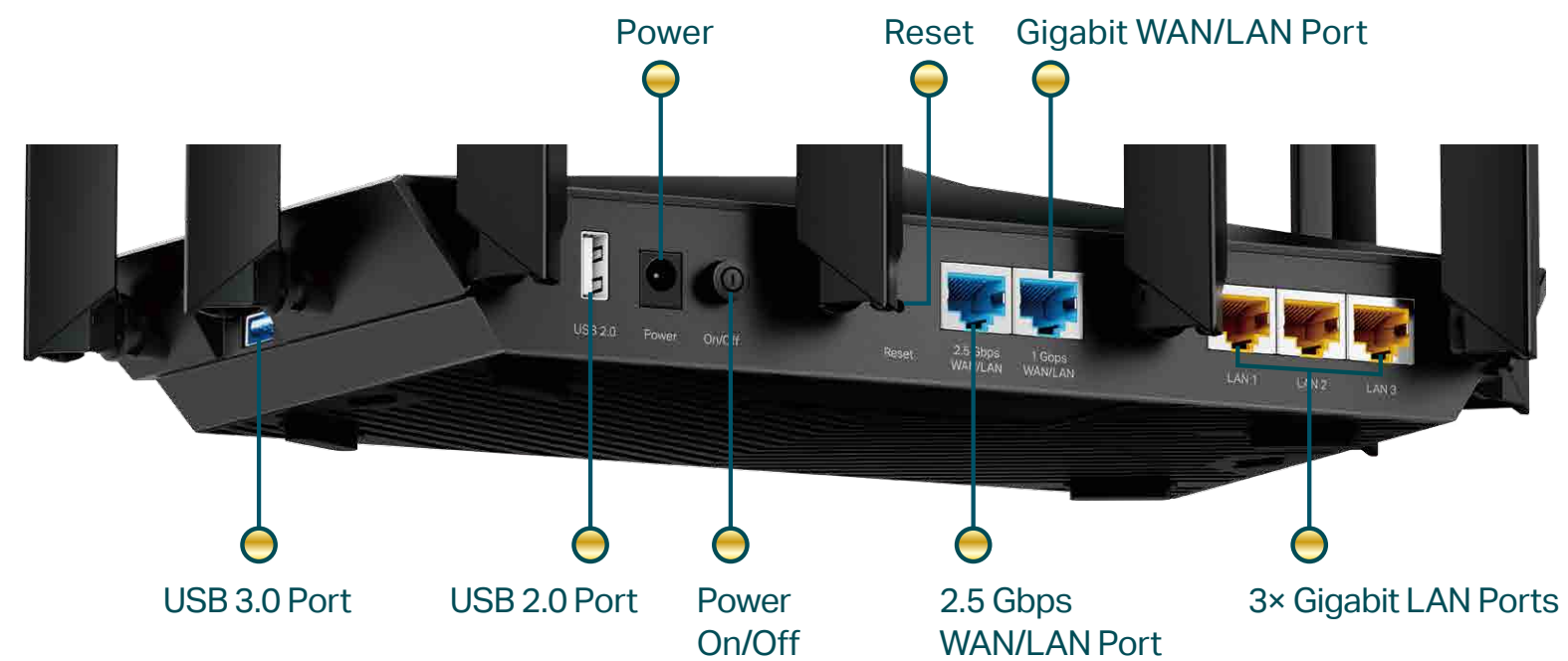

Wireless

- Wireless: 4804 Mbps (5 GHz, 11ax) + 1201 Mbps (5 GHz, 11ax) + 574 Mbps (2.4 GHz, 11ax), compatible with 11a/b/g/n/ac Wi-Fi standards
- Frequency: 2.4 GHz and 5 GHz
- Transmit Power:
FCC:<30dBm(2.4 GHz & 5.15 GHz~5.825 GHz)
CE: 2400 MHz -2483.5 MHz(20dBm); 5150 MHz -5250 MHz(23dBm); 5470 MHz -5725 MHz (27dBm)
- Reception Sensitivity:
2.4 GHz:
11n HT20 MCS0:-95dBm
11ax HE20 MCS11:-64dBm
11ax HE40 MCS11:-62dBm
5 GHz-1:
11ac VHT20 MCS0:-92dBm
11ax HE20 MCS11:-61dBm
11ax HE40 MCS11:-58dBm
11ax HE80 MCS11:-55dBm
5GHz-2:
11ac VHT20 MCS0:-95dBm
11ax HE20 MCS11:-61dBm
11ax HE40 MCS11:-58dBm
11ax HE80 MCS11:-55dBm
11ax HE160 MCS11:-53dBm
- Wireless Function: Enable/Disable Wireless Radio, WMM, Wireless Statistics
- Wireless Security: WPA/WPA2-Personal, WPA2/WPA3-Personal, WPA/WPA2-Enterprise

Specifications

Software

- Quality of Service: Device Prioritisation
- WAN Type: Dynamic IP/Static IP/PPPoE/PPTP(Dual Access)/L2TP(Dual Access)
- Management: Access Control, Local Management, Remote Management
- DHCP: Server, DHCP Client List, Address Reservation
- NAT Forwarding: Port Forwarding, Port Triggering, UPnP, DMZ
- Dynamic DNS: DynDns, NO-IP, TP-Link
- Access Control: Parental Controls, Local Management Control, Host List, White List, Black List
- Firewall Security: SPI Firewall, IP and MAC Address Binding
- Protocols: IPv4, IPv6
- USB Sharing: Supports Samba(Storage)/FTP Server/Media Server
- Guest Network: 2.4 GHz Guest Network, 5 GHz Guest Network
- VPN Server: OpenVPN, PPTP VPN

Others

- Certification:
FCC, CE, RoHS
- System Requirements:
Microsoft Windows 98SE/NT/2000/XP/Vista™/7/8/8.1/10, MAC OS, NetWare, UNIX or Linux

Internet Explorer 11, Firefox 12.0, Chrome 20.0, Safari 4.0, or other Java-enabled browser

Cable or DSL Modem

Subscription with an internet service provider (for internet access)
- Environment:
Operating Temperature: 0°C~40°C (32°F ~104°F)
Operating Humidity: 10%~90% non-condensing
- Package Contents
Wireless Router Archer AX90
Power Adapter
RJ45 Ethernet Cable
Quick Installation Guide



For more information, please visit

<http://www.tp-link.com/products/details/Archer-AX90.html>

or scan the QR code left

†Maximum wireless signal rates are the physical rates derived from IEEE Standard 802.11 specifications. Actual wireless data throughput and wireless coverage are not guaranteed and will vary as a result of network conditions, client limitations, and environmental factors, including building materials, obstacles, volume and density of traffic, and client location.

*Use of Wi-Fi 6 (802.11ax), and features including OFDMA, MU-MIMO, 1024-QAM, and HT160 require clients to also support the corresponding features.

*2.5 Gbps internet speeds require compatible service plans and equipment. 2.5 Gbps and Gigabit ports cannot be concurrently configured as WAN ports.

*Saving clients' battery power requires clients to also support the 802.11ax Wi-Fi standard. Actual power reduction may vary as a result of network conditions, client limitations, and environmental factors.

*HomeShield includes the Free Basic Plan. Fees apply for the Pro Plan. Visit tp-link.com/homeshield for more information

*Use of WPA3 requires clients to also support the corresponding feature.

*This router may not support all the mandatory features as ratified in Draft 3.0 of IEEE 802.11ax specification.

*Further software upgrades for feature availability may be required.

©2021 TP-Link

Highlights

WPA3 Security

The latest Wi-Fi security protocol, WPA3, brings new capabilities to improve cybersecurity. More secure encryption in Wi-Fi password safety and enhanced protection against brute-force attacks combine to safeguard your home Wi-Fi.*



Cutting-Edge Processing

A powerful 1.5 GHz quad-core CPU powers through multiple complex tasks and demanding applications with ease. Its processing power minimizes internal latency to keep your connections fast and uninterrupted.

