

GV-TDR2704 2MP H.265 Low Lux WDR Pro IR Mini Fixed Rugged IP Dome



- 1/2.7" progressive scan low lux CMOS sensor
- Min. illumination at 0.01 lux
- Dual streams from H.265, H.264 or MJPEG
- Up to 30 fps at 1920 x 1080
- Intelligent IR
- IR distance up to 30 m (100 ft)
- Built-in micro SD card slot (SD / SDHC / SDXC / UHS-I, Class 10) for local storage
- 3-axis mechanism (pan / tilt / rotate)
- Day and night function (with removable IR-cut filter)
- Ingress protection (IP67)
- Vandal Resistance (IK10)
- DC 12 V / PoE (IEEE 802.3af)
- Wide Dynamic Range (WDR Pro)
- Defog
- 3D noise reduction
- Motion detection
- Text overlay
- Privacy mask
- 12 languages supported
- ONVIF (Profile G, S, T) conformant

Introduction

The Mini Fixed Rugged IP Dome is an outdoor, fixed, network camera equipped with an automatic IR-cut filter and an IR LED for day and night surveillance. The camera supports H.265 video codec to achieve better compression ratio while maintaining high quality pictures at reduced network bandwidths. It adheres to IP67 and IK10 standards, and can be powered through PoE.

Models

Model	Iris	Focal Length (mm)	Horizontal FOV	Maximum Aperture	Image Format
GV-TDR2704-2F	Fixed	2.8 mm	113°	F/2.0	1/2.7"
GV-TDR2704-4F		4.0 mm	91°		

Dimensions

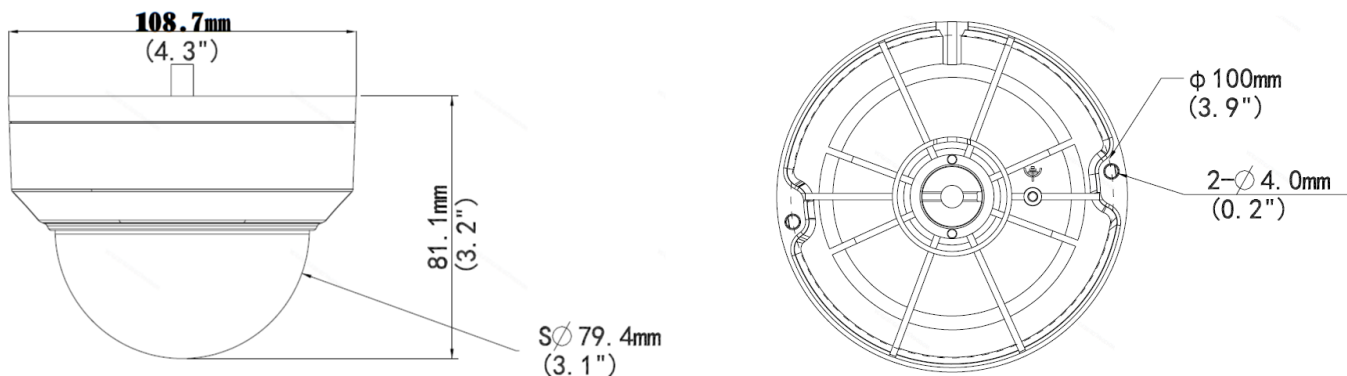

Specifications

Camera		
Image Sensor	1/2.7" progressive scan low lux CMOS	
Picture Elements	1920 (H) x 1080 (V)	
Minimum Illumination	Color	0.01 Lux (F2.0, AGC ON)
	IR ON	0 Lux
Shutter Speed	Auto / Manual (1 ~ 1/100,000 sec)	
White Balance	Auto / Manual	
Gain Control	Auto / Manual	
S/N Ratio	52 dB	
WDR Pro	Yes	
Dynamic Range	Up to 120 dB	
Lens		
	GV-TDR2704-2F	GV-TDR2704-4F
Megapixel	Yes	
Day / Night	Yes (with removable IR-cut filter)	
Lens Type	Fixed	
Focal Length	2.8 mm	4 mm
Maximum Aperture	F/2.0	
Mount	M12	
Horizontal FOV	113°	91°
Operation	Focus	Fixed
	Zoom	
	Iris	
IR LED Quantity	1 IR LED	
Max. IR Distance	30 m (100 ft)	
Operation		
Video Compression	H.265, H.264, MJPEG	
Video Streaming	Dual streams from H.265, H.264 or MJPEG	
Video Resolution	Main Stream	1920 x 1080 (Default), 1280 x 720
	Sub Stream	1280 x 720, 720 x 576, 704 x 288, 640 x 480, 640 x 360 (Default), 352 x 288
Frame Rate	30 fps at 1920 x 1080 (60 / 50 Hz) * The frame rate and performance may vary depending on the number of connections and data bitrates (different scenes).	
Video Analytics	Motion Detection, Tampering Alarm, Crossing line, Intrusion. *Tampering alarm, Cross Line, and Intrusion are only accessible through the camera's Web interface, which can be used to trigger alerts such as e-mail and FTP	
Image Setting	Brightness, Contrast, Saturation, Sharpness, Flicker-less, Image Orientation (Flip, Mirror, 0°, 90°, 180°, 270°-including Corridor format)	
Network		
Interface	10/100 Ethernet	
Protocol	802.1x, ARP, DHCP, DDNS, DNS, DynDNS, FTP, HTTP, HTTPS, ICMP, IGMP, IPv4, NTP, PPPoE, QoS, RTCP, RTP, RTSP, SMTP, SNMP, TCP, UDP, UPnP, ONVIF (Profile G, S, T)	
Mechanical		
Temperature Detector	No	
Camera Angle Adjustment	Pan	3° ~ 360°
	Tilt	0° ~ 68°
	Rotate	3° ~ 360°
Connectors	Power	DC Jack (DC 12 V, 1.25 A), PoE
	Ethernet	RJ-45 connector
	Local Storage	Micro SD card slot (SD / SDHC / SDXC / UHS-I, Class 10) *UHS-II card type is not supported.
General		
Operating Temperature	-30 °C ~ 60 °C (-22 °F ~ 140 °F)	
Humidity	10% ~ 90% (no condensation)	
Power Source	12 V DC / PoE (IEEE802.3af)	
Max. Power Consumption	5.0 W	
Dimensions	Ø 108.7 x 81.1 mm (Ø 4.3" x 3.2")	

Weight	0.36 kg (0.79 lb)
Ingress Protection	IP67
Vandal Resistance	IK10
Regulatory	FCC, CE, RoHS compliant
Web Interface	
Installation Management	Web-based configuration
Maintenance	Firmware upgrade through Web Browser or GV-IP Device Utility
Access from Web Browser	Live View, Video Recording, Change Video Quality, Bandwidth Control, Image Snapshot, Defog, Text Overlay, Image Masking
Language	Czech, English, French, German, Hungarian, Italian, Japanese, Polish, Portuguese, Russian, Spanish, Traditional Chinese
Applications	
Software Supported	GV-VMS (V17.4.1 / V18.2.1), GV-DVR / NVR (V8.9.1), GV-Control Center (V3.8.0), GV-Recording Server / Video Gateway (V1.4.0), GV-Edge Recording Manager Win version (V2.0.0), GV-Redundant / Failover Server (V1.1.0.0), GV-Mobile Server (V1.5.1)
Live Viewing	Browser (IE, Edge, Chrome, Firefox, Safari), Mobile App





Note:



1. It is required to apply patch files to some or all of the supported software.
2. Do not use clothes or any ordinary material to clean the camera cover since they may result in scratches.
3. Specifications are subject to change without notice.

Packing List

1. GV-TDR2704 Dome
2. Waterproof Rubber Set
3. Screw Kit
4. Torx Wrench
5. Drill Template Paster
6. Download Guide
7. Warranty Card

Accessories

Model No.	Name		Details
GV-Mount107 (must be used with GV-Mount213)	Pendant Bracket		Dimensions: Ø 120 x 334 mm (Ø 4.72" x 13.15") Weight: 0.74 kg (1.63 lb)
GV-Mount211P	Wall Mount and Junction Box		Dimensions: Ø 233 x 125 x 125 mm (Ø 9.2" x 4.9" x 4.9") Weight: 1 kg (2.2 lb)
GV-Mount213	Wall / Ceiling Box Mount		Dimensions: Ø 109 x 39 mm (Ø 4.3" x 1.5") Weight: 0.2 kg (0.44 lb)
GV-Mount300-2	Convex Corner Mount		Dimensions: 137 x 233 x 160 mm (5.4" x 9.17" x 6.3") Weight: 1.65 kg (3.64 lb)
GV-Mount310-2	Concave Corner Mount		Dimensions: 111.2 x 369.9 x 210 mm (2.6" x 11.4" x 6.6") Weight: 1.65 kg (3.64 lb)

<p>GV-Mount420 (must be used with GV-Mount211P)</p>	<p>Pole Mount Bracket</p>		<p>Dimensions: Ø 120 x 120 x 53.4 mm (Ø 4.7" x 4.7" x 2.1") Weight: 0.45 kg (0.99 lb) Steel Strap Diameter: Ø 67 ~ 127 mm (Ø 2.6" ~ 5")</p>
<p>GV-Mount704 (must be used with GV-Mount107)</p>	<p>Extension Tube</p>		<p>Dimensions: Ø 3.5 x 10 or 20 or 30 or 50 cm (Ø 1.38 x 3.9 or 7.9 or 11.8 or 19.7") Weight: 225g or 360g or 500g or 780g (0.5 lb or 0.79 lb or 1.1 lb or 1.72 lb)</p>
<p>GV-PA191</p>	<p>Power over Ethernet (PoE) Adapter</p>		<p>The GV-PA191 is a Power over Ethernet (PoE) adapter designed to provide power to the IP device through a single Ethernet cable.</p>
<p>GV-POE Switch</p>	<p>The GV-POE Switch is designed to provide power along with network connection for IP devices. The GV-POE Switch is available in various models with different numbers and types of ports.</p>		
<p>Power Adapter</p>	<p>Contact our sales representatives for the countries and areas supported.</p>		