



SPECIFICATION FOR APPROVAL

產品規格承認書

CUSTOMER APPROVAL(客戶簽章)
DATE(日期):

CUSTOMER(客戶): 海康威視

PART NO(料號): E99-KPL040F-L027 REV: C

DESCRIPTION(類別): ADAPTER (電源適配器)

*PLEASE SIGN AND RETURN ONE COPY.

*ALL PRODUCTION UNITS WILL BE BUILT ACCORDING TO THIS SPECIFICATIONS.

*請客戶簽名並返回一份復本給我司，後續生產交貨依此份承認書為準

PREPARED(制定)	CHECKED(確認)	APPROVED(核准)
潘小琪	鄭斌	鄭斌
DATE : 2016.03.24	DATE : 2016.03.24	DATE :2016.03.24

MODEL NO(產品型號): KPL-040F-VI 12V/3.33A 2464#18 2PIN (紅色為+ 黑色為-)*1200mm

WEB SITE(網址):[Http://www.cwtnc.com.cn](http://www.cwtnc.com.cn)

[Http://www.cwt.com.tw](http://www.cwt.com.tw)

E-mail(電子郵件):guanshuo@cwtnc.com.cn

ADDRESS:10,Chuang-ye Rd,The West of Ningbo Free Trade Zone,Ningbo,Zhejiang,P.R. China.

地址:中國，浙江省，寧波市，寧波保稅區西區，創業大道10號

TEL(電話):0574-86879335

FAX(傳真):0574-86879078



Table of Contents

1	SCOPE	5
2	ELECTRICAL SPECIFICATION	5
2.1	INPUT REQUIREMENT	5
2.1.1	Input voltage range	5
2.1.2	Input frequency range	5
2.1.3	AC inrush current	5
2.1.4	Input current	6
2.1.5	Low power consumption	6
2.2	INPUT PROTECTION	6
2.2.1	Input current protection	6
2.3	OUTPUT REQUIREMENT	6
2.3.1	Output power	6
2.3.2	Output voltage and current	6
2.3.3	Ripple and noise	7
2.3.4	Over voltage protection	7
2.3.5	Over current protection	7
2.3.6	Overshoot	7
2.3.7	Short circuit Protection	7
2.3.8	Audible noise	8
2.4	PERFORMANCE REQUIREMENT	8
2.4.1	Efficiency	8
2.4.2	Turn on delay time	8
2.4.3	Hold-up time	8
2.4.4	Dynamic load	8
3	ENVIRONMENTAL SPECIFICATION	9
3.1	TEMPERATURE	9
3.2	HUMIDITY	9
3.3	VIBRATION AND SHOCK	9
3.4	ALTITUDE	9
3.5	CALCULATED MEAN TIME BETWEEN FAILURES (MTBF)	9
3.6	BURN-IN	9

ISSUE DATE: 2016/3/23	Revision No.: 3.0	
Specification No:	Page: 3 of 13	



4 APPLICATION STANDARD &RELATED SPECIFICATION.....10

4.1.1 SAFETY STANDARD 10

4.1.2 EMI 10

4.1.3 Dielectric strength—(Hi-pot)..... 11

4.1.4 Insulation resistance 11

4.1.5 GROUNDING..... 11

Power supply AC inlet PE pin to DC +12.0V GND 0.1 ohm max at 40A/3second..... 11

4.1.6 Leakage current 11

4.1.7 Surge 12

4.1.8 Electrostatic discharge ESD 12

4.1.9 Electrical Fast Transients (EFT) 12

4.1.10 Environment standards 12

5 MECHANICAL12

5.1 INPUT CONNECTOR AND OUTPUT CABLE 12

5.1.1 Input connector 12

5.1.2 Output cable..... 12

5.2 AC ADAPTER EXTERNAL DIMENSION..... 13

ISSUE DATE: 2016/3/23	Revision No.: 3.0	
Specification No:	Page: 4 of 13	



1 SCOPE

This document describes basic electrical characteristics and mechanical characteristic of 40 W power adapters.

2 ELECTRICAL SPECIFICATION

2.1 INPUT REQUIREMENT

2.1.1 INPUT VOLTAGE RANGE

Industrial power supply shall operate within input specification from 90Vac to 264Vac or provide automatic switching between high line and low line input ranges. The table below shows common input voltage range.

Input Range	Minimum	Nominal	Maximum	Unit
	90 V	100V- 240V	264V	Vac Rms

Table 1 - Input Voltage Range

2.1.2 INPUT FREQUENCY RANGE

The industrial power supply shall operate within specification from 47 to 63 Hz.

2.1.3 AC INRUSH CURRENT

Peak inrush current should not exceed 100 A at 240Vac, 50Hz, 25 degrees C, cold start. It should not interrupt line fuse or cause damage to the industrial power supply either at cold or warm start.

Peak inrush current should not exceed 60 A at 100Vac, 60Hz, 25 degrees C, cold start. It should not interrupt line fuse or cause damage to the industrial power supply either at cold or warm start.

The inrush current must be limited to the extent that no damage is done to the supply under any specified line, load, and temperature conditions. The inrush current shall not cause any external protection devices (i.e. fuses) to trip.

ISSUE DATE: 2016/3/23	Revision No.: 3.0	
Specification No:	Page: 5 of 13	



2.1.4 INPUT CURRENT

Maximum steady state input current shall not exceed 1.7 A for any line voltage specified in 2.1.1

2.1.5 LOW POWER CONSUMPTION

Vin	Load	Power consumption
230Vac/50Hz 115Vac/60Hz	0A	≤ 0.075 W

2.2 INPUT PROTECTION

2.2.1 INPUT CURRENT PROTECTION

A fuse with rating of 3.15 A / 250 V (Time Lag type) shall be installed on the input line side near the input connector and no any electrical components before.

2.3 OUTPUT REQUIREMENT

2.3.1 OUTPUT POWER

The total output power, under steady state conditions, shall not exceed 40 W.

2.3.2 OUTPUT VOLTAGE AND CURRENT

Under any combination of line and load variation and environmental conditions, all outputs shall remain within tolerance as defined in Table 2. Output voltage(s) shall be measured at the load side of output connector.

Output Voltage	Voltage Range		Current Range		
	Lower Limit	Upper Limit	Minimum Load	Full rated load	PK Load
+12.0V	11.40V	12.60V	0.0A	3.33A	5.20A

Table 2 - Output Voltage and Current

ISSUE DATE: 2016/3/23	Revision No.: 3.0	
Specification No:	Page: 6 of 13	



2.3.3 RIPPLE AND NOISE

Measurements shall be made with an oscilloscope with minimum of 20MHz bandwidth and 1:1 scope Probe, Output shall be bypassed at the connector with a 0.1 μ F ceramic disk capacitor and a 47 μ F electrolytic capacitor for general testing purpose.

Output Voltage	Maximum Ripple & Noise (Vp-p)
+12.0V	240mV

Table 3 – Ripple and Noise

2.3.4 OVER VOLTAGE PROTECTION

The power supply shall provide with over voltage protection such that under any single component failure.

The power supply provides output over voltage protected in latch off by zener diode, and no damage to customer device.

2.3.5 OVER CURRENT PROTECTION

The power supply shall be protected when operating any output in overload condition. The power supply shall be shut down and no any damage when the over current condition occurs on the output, and It will be auto-recovered when the failure is removed.

Output Voltage	Over current protection		Test condition
	Lower Limit	Upper Limit	Input voltage:100Vac 60Hz or 240Vac 50Hz.
+12.0V	5.50 A	9.00A	

Table 4 –Over current protection

2.3.6 OVERSHOOT

During turn on or turn off, the output overshoot shall not exceed nominal output voltage by more than 5%, and output shall not change its polarity with respect to its return line.

2.3.7 SHORT CIRCUIT POTECTION

Power supply shall have self-limiting protection to protect against short circuit or overload conditions. No damage to the power supply shall result from a continuous or intermittent short circuit condition. It will be auto-recovered when the failure is removed.

ISSUE DATE: 2016/3/23	Revision No.: 3.0	
Specification No:	Page: 7 of 13	



2.3.8 AUDIBLE NOISE

There is no audible noise canned been heard when it work with rated spec.

2.4 PERFORMANCE REQUIREMENT

2.4.1 EFFICIENCY

Active average mode Efficiency (watt out / watt in) shall be a minimum of 88.59 % at 230vac/50Hz.

Active average mode Efficiency (watt out / watt in) shall be a minimum of 87.59 % at 115vac/60Hz.

Complies to EPA DOE standard specification and EU CEC standard specification (Level VI).

calculate the model is single average active mode efficiency for each test voltage by testing at 100%,75%,50%,and 25% of rated current output and then computing the simple arithmetic average of these four values respectively at 115V/60HZ and 230V/50HZ test result for reference.

Efficiency (watt out / watt in) shall be a minimum of 78.59 % at 10% full load.

Note: when testing efficiency, adapter needs to electrify to perform after full load 60 minutes

Input voltage 115Vac 60Hz or 230Vac 50Hz

2.4.2 TURN ON DELAY TIME

Output shall reach steady state within 5 seconds of turn on at 100Vac or greater.

Output shall reach steady state within 2 seconds of turn on at 240Vac or greater.

2.4.3 HOLD-UP TIME

Hold-up time shall be a minimum of 8 mS at 100Vac / 60Hz input.

2.4.4 DYNAMIC LOAD

Power supply output voltage tolerance shall be complied with $\pm 5\%$.

Step load change: from 50% to100% Load on the output.

Dwell Time: 100Hz & 1 KHz 50% duty.

Slew rate: 0.5A/uses

ISSUE DATE: 2016/3/23	Revision No.: 3.0	
Specification No:	Page: 8 of 13	



3 ENVIRONMENTAL SPECIFICATION

3.1 TEMPERATURE

Operation within specification: 0 to 40 degrees C.

Storage: -20 to 70 degrees C

Note: It can start normally at -25 °C@110V/1.0A

Full Load of working is normal for 8 hours at 60 °C

3.2 HUMIDITY

Operation: 10% to 90% relative humidity, non-condensation.

Storage: 5% to 95% relative humidity, including condensation.

3.3 VIBRATION AND SHOCK

The power supply shall be designed to withstand normal transportation vibration per MIL-STD-810F, method 514 and procedures X, as it is mounted in the chassis assembly and packed for shipping.

3.4 ALTITUDE

The power supply shall operate properly at any altitude between 0 ~ 16,404 feet (5000 meter) above sea level, and withstand storage at 50,000 feet.

3.5 CALCULATED MEAN TIME BETWEEN FAILURES (MTBF)

The MTBF for the power adapter shall equal or exceed 100,000 hours when operated at full rated load in an ambient temperature of 25 degree C.

3.6 BURN-IN

Burn-in test:

Test condition: 110Vac / 220Vac 50Hz, with 100% maximum load at 45 ±5°C ambient temperature.

Test method: burn-in 110 minutes; and 30 seconds "ON", 30 seconds "OFF" within 5 minutes, then 5 minutes "ON"

Test criteria: during this conditioning the power supply output normal and no damage or hazardous condition will occur.

ISSUE DATE: 2016/3/23	Revision No.: 3.0	
Specification No:	Page: 9 of 13	



ORT and life test:

Input condition: 110Vac / 220Vac 50Hz, "ON/OFF" 10 times within 5 minutes,45 minutes "ON"
45 minutes "OFF",

Test condition: cycle by cycle test 168 hours with 100% maximum load at 45 ±5°C ambient temperature.

Test criteria: during this conditioning the power supply output normal and no damage or hazardous condition will occur.

4 APPLICATION STANDARD &RELATED SPECIFICATION

4.1.1 SAFETY STANDARD

Agency	Certification required	Countries
UL	UL60950-1(QQGQ,QQGQ7;AZSQ,AZSQ7)	US
cUL	CAN/CSA C22.2 No. 60950-1-07, 2nd Edition	Canada
CB	IEC 60950-1:2005 (Second Edition) + Am 1:2009 + Am 2:2013 IEC 60065:2001 (Seventh Edition) + A1:2005 + A2:2010	IEC
CCC	GB 4943.1-2011;GB8898-2011	China
BSMI	CNS13438, CNS14336	Taiwan
GS	EN 60950-1:2006+A11+A1+A12+A2; EN60065:2002+A1+A11+A2+A12	Germany
S-MARK	IEC 60065:2001+A1+A2	Argentina
RCM	AS/NZS 60950.1:2011+A1	Australia
KC	K60950-1(2006-12)	Korea
PSE	J60950-1(H25)	Japan
VCCI	VCCI:2015-04 Class B	Japan
FCC	47 CFR Part2,part15 CISPR PUB.22	US
EAC	TP TC 004/2001 , TP TC 020/2011	Russia
NOM	NOM-001-SCFI-1993	Mexico
BIS	IS 13252(PART 1):2010+A1 : 2013	India
CE	EN 55022:2010, E55024:2010, EN61000-3-2:2014, EN 61000-3-3:2013 EN55020:2007+A11:2007 EN 55013:2013, 2014/30/EU	Europe
IC	ICES-003 Issue 5 (2012) , Class A	Canada

(Currently All certification marks meet safety requirement only)

ISSUE DATE: 2016/3/23	Revision No.: 3.0	
Specification No:	Page: 10 of 13	



4.1.2 EMI

VCCI Class-B

FCC 15(Class-B, 115Vac operation)

CISPR 22 Class-B limits

EN55022 (1998+A1:2000+A2:2003 Class-B limits) under 6dB

47 CFR Part 15, Subpart B, Class B limits

GB 9254 ITE Emissions Latest Edition

GB 17625.1 Harmonics Latest Edition

4.1.3 DIELECTRIC STRENGTH—(HI-POT)

Primary to secondary: 1500VAC.

Test time: 60 second

Cut-off current: 5mA max

Arcing current: 10mA max

4.1.4 INSULATION RESISTANCE

Insulation resistance shall be more than 100M ohm between primary and secondary under normal atmospheric conditions

Insulation resistance shall be more than 10M ohm between primary and secondary in hot and humid conditions

4.1.5 GROUNDING

POWER SUPPLY AC INLET PE PIN TO DC +12.0V GND 0.1 OHM MAX AT 40A/3SECOND

4.1.6 LEAKAGE CURRENT

0.75 mA maximum at 264Vac 50Hz

ISSUE DATE: 2016/3/23	Revision No.: 3.0	
Specification No:	Page: 11 of 13	



4.1.7 SURGE

It is referring to EN61000-4-5 IEC61000-4-5:2001 Level 4.

Differential mode surge immunity: 2KV

Common-mode Surge Immunity: 4KV

* **Determination level: Criteria A (Product testing and testing before and after any change in function is not).**

4.1.8 ELECTROSTATIC DISCHARGE ESD

It is referring to EN61000-4-2, IEC61000-4-2:2001, IEC801-2 Level 3.

Contact electrostatic discharge: + - 6KV.

Air electrostatic discharge: + - 8KV.

* **Determination level: Criteria A (Product testing and testing before and after any change in function is not).**

4.1.9 ELECTRICAL FAST TRANSIENTS (EFT)

It is referring to IEC61000-4-4: Test Voltage \geq 2KV.

* **Determination level: Criteria A (Product testing and testing before and after any change in function is not).**

4.1.10 ENVIRONMENT STANDARDS

RoHS Regulation

The RoHS compliance symbol will be included on the data plate.

5 MECHANICAL

5.1 INPUT CONNECTOR AND OUTPUT CABLE

5.1.1 INPUT CONNECTOR

AC Input connector shall be IEC320 C14 power connector.

5.1.2 OUTPUT CABLE

ISSUE DATE: 2016/3/23	Revision No.: 3.0	
Specification No:	Page: 12 of 13	



MODEL NO : KPL040F-VI 12.0V/3.33A
ENGINEERING SPECIFICATION SHEET(海康專用)

The output cable shall be UL2468#18AWG 1200 +/- 20mm.

5.2 AC ADAPTER EXTERNAL DIMENSION

ISSUE DATE: 2016/3/23	Revision No.: 3.0	
Specification No:	Page: 13 of 13	

版本	修訂內容	修訂者	日期

A

B

C

D

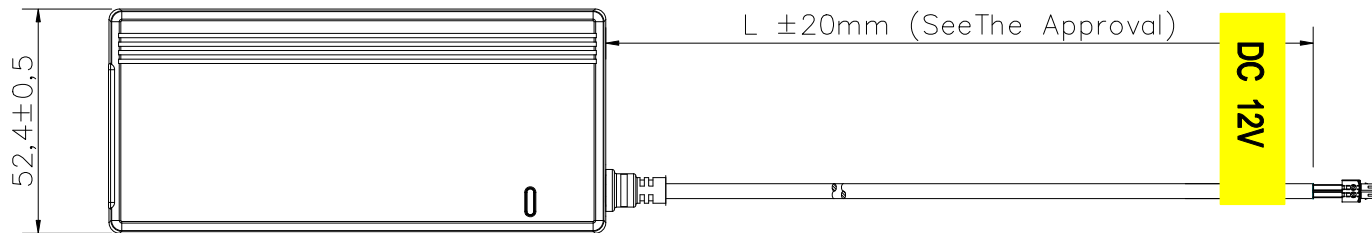
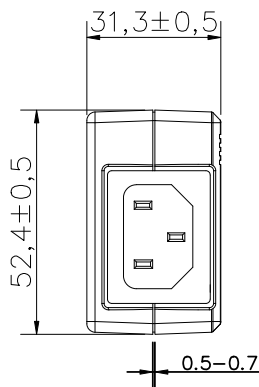
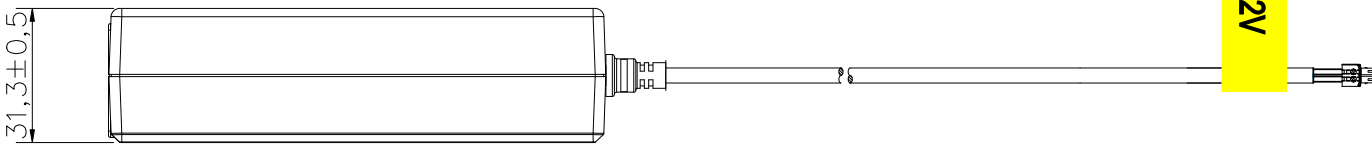
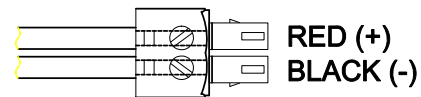
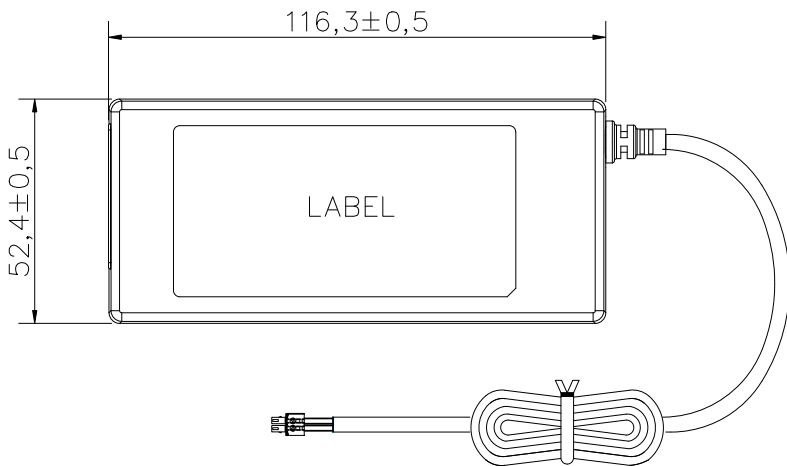

環保材料標準：

No	有害物質名稱	含量標準	SHEET METAL TOLERANCE (UNLESS OTHERWISE SPECIFIED)				單重: g	0.1	DESCRIPTION		
			DIMENSION	PIERCING	BENDING	ANGULAR			REV.	UNIT: mm	MODEL NO.: KPLxxx
1	鎘 (Cd)	<75ppm									
2	鉛 (Pb)	<800ppm									
3	汞 (Hg)	<800ppm	X < 8	±0.1	±0.15	±0.3°					
4	六價鉻 (Cr)	<800ppm	8 ≤ X < 25	±0.1	±0.2	±0.5°					
5	多溴聯苯 (PBB)	<800ppm	25 ≤ X < 100	±0.15	±0.25	±0.5°		APPROVED	CHECKED	DESIGNED	
6	多溴二苯醚 (PBDE)	<800ppm	100 ≤ X < 300	±0.2	±0.3	±1°		叶明荣	郑斌	管典锋	
7	錳, 鉛, 汞, 六價鉻 (包裝材料)	總含量<100ppm	300 ≤ X < 800	±0.3	±0.5	±1.5°		DATE: 20110407	DATE: 20110407	DATE: 20110407	



MODEL No.: KPL-040F-VI

料號: G35-D017683-P200

REV: B

工作要點

- 1.材質: 100#消銀龍+OPP(UL安規) (厚度0.15~0.2mm)
- 2.SIZE:79.5*39.5mm
- 3.顏色:銀底黑字.
- 4.印刷字體大小,位置,內容詳見drawing.
- 5.印刷必須清晰不得有斷線,模糊不清等不良現象.
- 6.背膠必須耐溫80°C,2H不會產生翹起,起泡等不良現象.
- 7.請參照RoHS and REACH環保標準生產.
- 8.UL必須符合PGDQ2.
- 9.最小包裝上必須有廠商名稱或LOGO,產品名稱,產品型號,規格, UL Mark以及UL Number.

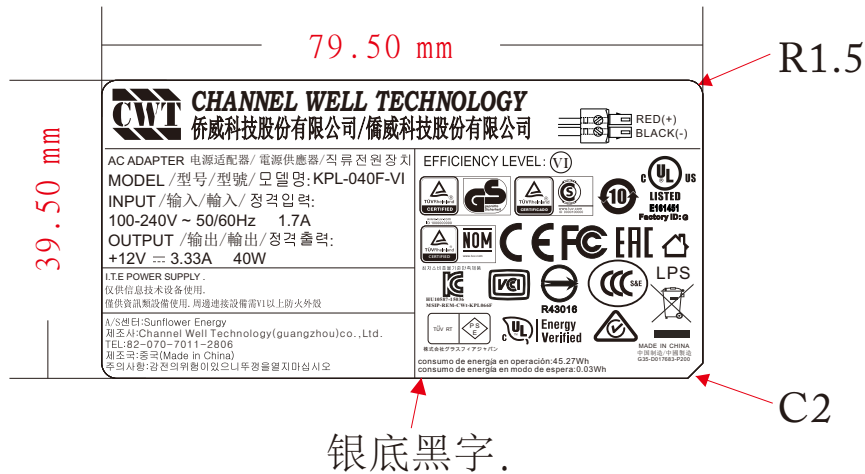

0.2 2016.03.22 加上所有已申報安規

ISSUE BY:

王艷麗

CHECK BY:

宋書軍

APPROVED:

宋書軍

1 2 3 4 5 6

A

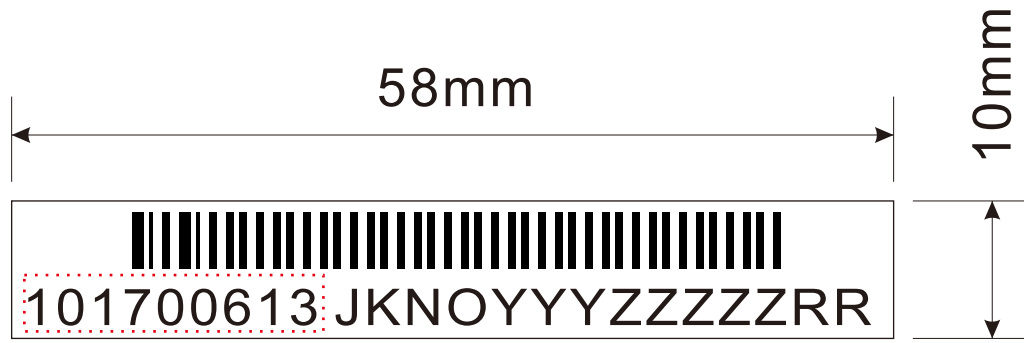

B

此代碼信息不含在條碼信息里，
條碼信息只含“S/N”的信息

嘉葵主件料號	海康物料代碼	電源型號代碼(說明1)	產品版本(說明2)
E99-KPL040F-L027	101700613	NO	A2

C

注：
 JK:代表嘉葵(固定不變)
 NO:代表電源型號(說明1, 固定不變)
 YY(前兩個Y):代表生產年份, 用字母A~J代表數字0~9, 如07年用AH表示
 Y(后一個Y):代表生產月份, 用字母A~L代表數字1~12, 如5月用“E”表示, 10月用“J”表示
 ZZZZ:代表流水號(00001-99999, 10萬以上的從0A000-0A999, 0B000-0B999, 0Z000-0Z999, 其中字母I和O不要)
 RR:代表產品版本(說明2), (版本編碼原則: 從A1~AN, B1~BN.....Z1~ZN)

D

- 工作要點:
1. 材質: 格拉辛底銅版紙
 2. 印刷必須清晰可見, 不能有斷線, 模糊不清等不良
 3. 貼紙的印刷油墨, 紙張材質及背膠覆膜都必須符合RoHS要求
 4. 背膠必須耐溫80° C不會翹起
 5. 編碼原則: 128碼
 6. 尺寸: 58*10mm (公差: +/-0.3)

環保材料標準

No	有害物質名稱	含量標準	SHEET METAL TOLERANCE (UNLESS OTHERWISE SPECIFIED)				單重: g	0.2	2016.03.22 大貼紙變更, 條碼版本變更						
			DIMENSION	PIERCING	BENDING	ANGULAR	REV.	DESCRIPTION							
1	鎘(Cd)	<75ppm													
2	鉛(Pb)	<800ppm													
3	汞(Hg)	<800ppm	X<8	±0.1	±0.15	±0.3°									
4	六價鉻(Cr) ⁶⁺	<800ppm	8<X<25	±0.1	±0.2	±0.5°									
5	多溴聯苯(PBB)	<800ppm	25<X<100	±0.15	±0.25	±0.5°	APPROVED	CHECKED	SAFETY	DESIGNED					
6	多溴二苯醚(PBDE)	<800ppm	100<X<300	±0.2	±0.3	±1°	龔連濤	劉清		王艷麗	SCALE:		SHEET	M	
7	銅,鉛,汞,六價鉻, (包裝材料)	總含量<100ppm	300<X<800	±0.3	±0.5	±1.5°	DATE:20151127	DATE:20151127	DATE:	DATE:20151127	THIRD ANGLE PROJECTION	1 OF 1	A4		



版本	修訂內容	修訂者	日期

A

B

C

D

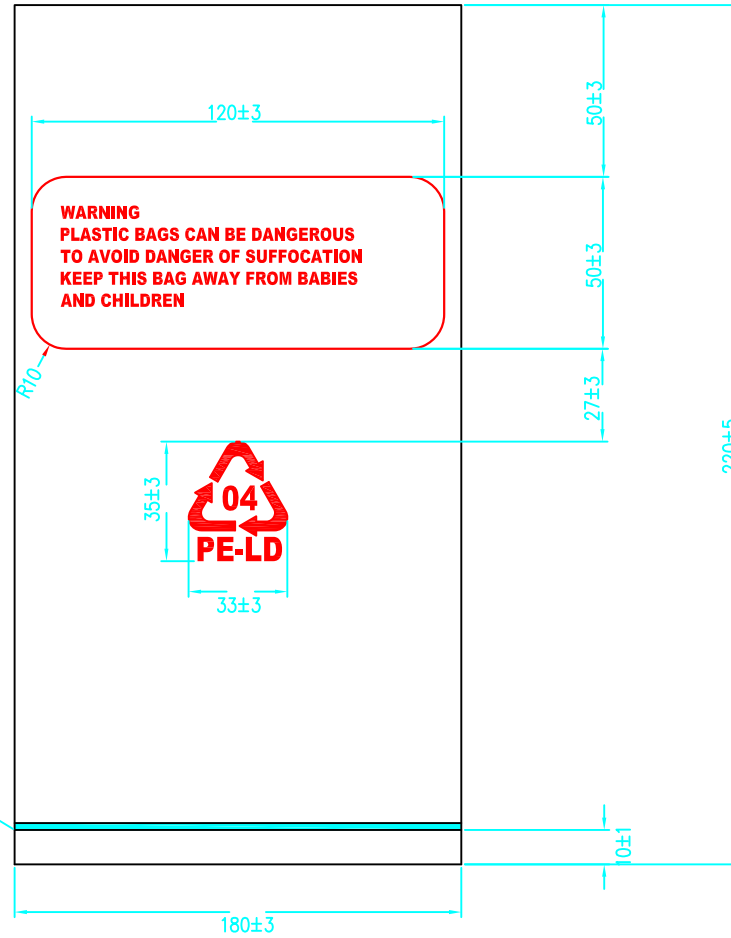

- 1.材質：干性PE袋 t=0.04mm
- 2.熱壓線寬度不得小於0.25mm
- 3.熱壓線需壓實，不得破裂與熱熔破孔
- 4.袋壁不得破裂
- 5.回收標志及警告文字和邊框印刷為紅色
- 6.警告文字字體為Arial Black
- 7.文字邊框線寬0.5mm
- 8.印刷內容需距中，不得偏歪

環保材料標準：

No	有害物質名稱	含量標準	SHEET METAL TOLERANCE (UNLESS OTHERWISE SPECIFIED)			
			DIMENSION	PIERCING	BENDING	ANGULAR
1	鎘 (Cd)	<75ppm				
2	鉛 (Pb)	<800ppm				
3	汞 (Hg)	<800ppm	X < 8	±0.1	±0.15	±0.3°
4	六價鉻 (Cr)	<800ppm	8 ≤ X < 25	±0.1	±0.2	±0.5°
5	多溴聯苯 (PBB)	<800ppm	25 ≤ X < 100	±0.15	±0.25	±0.5°
6	多溴二苯醚 (PBDE)	<800ppm	100 ≤ X < 300	±0.2	±0.3	±1°
7	鎘, 鉛, 汞, 六價鉻 (包裝材料)	總含量<100ppm	300 ≤ X < 800	±0.3	±0.5	±1.5°

單重: g	0.1	REV.	DESCRIPTION
		UNIT: mm	MODEL NO.: KPLxxx
		MATERIAL	PART NO.: G25-B220005-P100
		*****	DRAWING NO.:
APPROVED	CHECKED	DESIGNED	SCALE:
管典鋒	管典鋒	管典鋒	SHEET M
DATE:	DATE:	DATE: 20110408	THIRD ANGLE PROJECTION
			1 OF 1 A4L

1	2	3	4	5	6
版本	修訂內容	修訂者	日期		
0.1	新制訂	張寅	20130123		
0.2	为节约空间, 便于运输, 变更外箱尺寸, 长度由577mm变为550mm, 高度由372mm变为326mm, 装箱数量不变	張寅	20130724		
0.3	備註物料標示單粘貼位置及尺寸	王艷麗	2016.02.25		

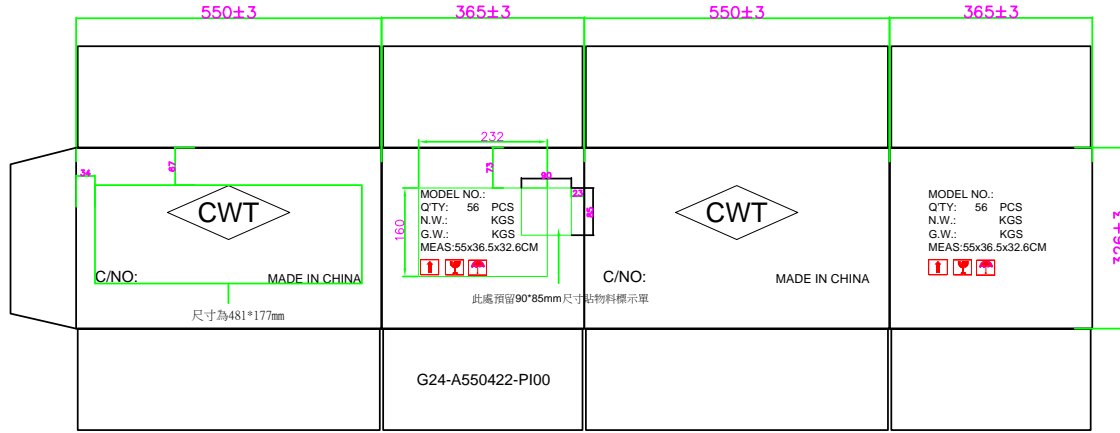

以上符號印刷為紅色
其他印刷為黑色

側麥印刷尺寸大小
週邊線不需印刷

MODEL NO.:
QTY: 56 PCS
N.W.: KGS
G.W.: KGS
MEAS: 55x36.5x32.6CM

箱內長寬尺寸必須保證最小為538*353mm

綠色方框與字體無需印刷

- 配套:
- 八刀卡(每箱配10PCS)
料號: G24-B531451-PI00
 - 五刀卡(每箱配16PCS)
料號: G24-B351441-PI00
 - 隔板(每箱配3PCS)
料號: G24-B533511-PI00

- NOTES:
- 材質: 五層瓦楞紙A/B(B+C楞), 破裂強度8.0KGS(MIN); 抗壓強度260KGS(MIN); 邊壓強度3.2KN/M(MIN)
 - 厚度: 6±0.5mm.
 - 搭配誤差: 與格板之間間隙要大於2mm, 小於6mm.
 - 警告標志及ROHS印刷顏色: 紅色(PANTONE 1788C), 其它字體印刷黑色.
 - 虛線為預折壓痕.
 - 請依圖面標示尺寸制作.
 - 公差: 其它未標注公差

- ★ 圖形及字體公差: 10mm以下為+/-1mm, 11~50mm為+/-3mm, 51mm以上為+/-5mm, 特殊情況除外.
 - ★ 偏移公差: 10mm以下為+/-2mm, 11~50mm為+/-3mm, 51mm以上為+/-5mm, 特殊情況除外.
8. 結合方式(一體成形): 打釘.
外箱最少要打三排釘; 外箱尺寸較高時, 打釘數要保證兩釘之間的距離要小於100mm, 且間距保持基本均勻(公差+10/-10mm)
9. 所有材料需符合RoHS環保要求.
10. 每箱裝56PCS
N.W≈15.5Kg, G.W≈18Kg

環保材料標準

No	有害物質名稱	含量標準	SHEET METAL TOLERANCE (UNLESS OTHERWISE SPECIFIED)			
			DIMENSION	PIERCING	BENDING	ANGULAR
1	鎘(Cd)	<75ppm				
2	鉛(Pb)	<800ppm				
3	汞(Hg)	<800ppm	X < 8	±0.1	±0.15	±0.3*
4	六價鉻(Cr ⁶⁺)	<800ppm	8 ≤ X < 25	±0.1	±0.2	±0.5*
5	多溴聯苯(PBB)	<800ppm	25 ≤ X < 100	±0.15	±0.25	±0.5*
6	多溴二苯醚(PBDE)	<800ppm	100 ≤ X < 300	±0.2	±0.3	±1*
7	鎘, 鉛, 六價鉻(包裝材料)	總含量<100ppm	300 ≤ X < 800	±0.3	±0.5	±1.5*

單重:g	0.3		
REV.		DESCRIPTION	
冠碩電子	UNIT: mm	MODEL NO.: KPLxxx	
	MATERIAL	PART NO.: G24-A550422-PI00	
		DRAWING NO.: KPL 蜂槽裝	
APPROVED	CHECKED	DESIGNED	SCALE:
DATE: 20130724	DATE: 20130724	DATE: 20130724	SHEET M / 1 OF 1 A4L