



OLB

CAJA OVAL

Para Instalaciones Industriales y Comerciales
Con Tapa
Para tubo Rígido e IMC



LISTED



OLL



OT



OC



OLR

INYECTADOS

SAWELT®

Fabricación e Integración 100% Nacional
HECHO EN MÉXICO

Manufacturing and Integration 100% National.
Made in Mexico



Las cajas de registro ovas RAWELT son diseñadas y fabricadas bajo los mas estrictos controles de calidad, certificadas en normas internacionales, por UL y CSA siendo utilizadas en la industria tanto pesada como ligera, así mismo en aplicaciones comerciales como residenciales.

Gracias a el método de moldeo por inyección a presión, sus paredes de aluminio son compactas y libres de porosidad obteniéndose una estabilidad dimensional y una resistencia extraordinaria para ser usadas en cualquier tipo de industria, con un peso 3 veces más ligero que otro sistema de moldeo.

- Roscas **NPT** concéntricas a la boca para un sellado, ajuste y escuadre perfecto a 90° en el tubo ensamblado.
- Resistente a ambientes húmedos y altamente corrosivos.
- Acabados de máxima durabilidad, como pintura Epoxy-Poliester termoendurecida, para ambientes húmedos y corrosión con pruebas de cámara salina de más de 500 horas, y con recubrimiento de **PVC** exterior y **Uretano RAWELT Purpura** en el interior para ambientes extremadamente corrosivos con pruebas de cámara salina de más de 1000 horas..

En **RAWELT** contamos con la infraestructura necesaria para diseñar y construir herramientas y maquinaria para la fabricación de nuestros propios productos, sin depender de terceros, manteniéndolos en optimo estado teniendo total y absoluto control de nuestros procesos, revisando la calidad en cada fase de la fabricación, desde la materia prima hasta el empaclado y entrega del producto.

Gran inventario en nuestros almacenes propios, estratégicamente distribuidos para una entrega rápida y completa. Obteniendo un ahorro económico y de espacio en sus inventarios.

Cuerpo: Aluminio inyectado a presión

Tapa: Lamina de aluminio troquelada con resistencia de **17000 PSI**

Empaque: Neopreno

Acabado: Pintura electroestática Epoxy-Poliester termoendurecida

Certificaciones:

UL 514 A y CSA-C22.2 No. 18-92

UL FILE: E135600

CSA FILE: LR105795-1

The RAWELT oval conduit boxes are designed and manufactured under the most strict quality controls and certified in international standards by UL and CSA, it is used in both heavy and light industry, also in commercial and residential applications.

Thanks to the method of diecasting, the aluminum walls are compact, thin and free of porosity obtaining a dimensional stability and outstanding resistance to be used in any industry, weighing lighter three times that another moulding system.

- Concentric **NPT** threads to the hubs for a sealing, adjustment and perfect 90° squaring in the assembled **NPT** pipe.
- Wet and highly corrosive environments resistant.
- High durability finishes, thermoset epoxic-polyester powder coating, for wet and corrosive environments with 500 hours salt spray fog test and exterior **PVC** and interior **RAWELT Urethane Purple** for high corrosives environments with 1000 hours of salt spray fog test.

RAWELT has the infrastructure to design and built the machinery and tooling to manufacture their own products, without relying third parties, and keeping them in optimal condition to have total and absolute control of our processes, checking the quality at every stage of manufacturing, from raw materials to packaging and product delivery.

Large inventory in our warehouses, strategically located for quick and complete delivery. Obtaining economic and space savings in your inventory.

Body: Diecast Aluminum

Cover: Aluminum stamped sheet with 17000 PSI of resistance

Gasket: Neoprene

Finish: Electrostatic powder coating thermoset

Certifications:

UL 514 A y CSA-C22.2 No. 18-92

UL FILE: E135600

CSA FILE: LR105795-1



LISTED



1.6 - CAJA OVAL. CON TAPA. PARA TUBO RIGIDO E IMC.

1.6 - OVAL CONDUIT BODIES. WITH COVER. FOR USE WITH RIGID AND IMC CONDUIT.

FICHA TECNICA / TECHNICAL DATA

007 - RW - 277

- Material:
 - Cuerpo: Aluminio inyectado a presión (diecast).
 - Tapa: Lámina de Aluminio.
 - Tornillos: Galvanizados.
- Acabados: Pintura electrostática epoxica/poliester polimerizada.
- Rosca NPT para usarse con tubo conduit RIGIDO e IMC.
- Tapa y tornillos ensamblados.
- Empaque: Proporciona hermetismo al agua.
- Fabricación en base a: UL 514 A
CAN/CSA-C22.2 No. 18-92

- Material:
 - Body: Diecast aluminum.
 - Cover: Sheet aluminum.
 - Screws: Galvanized steel.
- Finish: Electrostatic powder epoxy/poliester coating.
- NPT threaded for use with RIGID and IMC conduit.
- Cover and screws assembled.
- Gasket: Provide rain tight.
- Manufactured in compliance with: UL 514 A
CAN/CSA-C22.2 No. 18-92

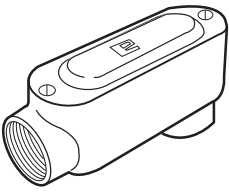
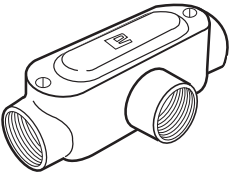
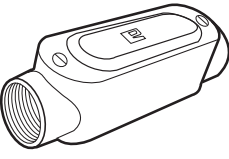

USAR No. DE CODIGO PARA HACER PEDIDOS / TO ORDER USE CODE NUMBER

Figura Figure	Catalogo Catalog	Codigo Code	Medida nominal Hub size		Volumen Volume		Peso x 100 pzas. Weight x 100 pcs.		Unit Ctn. Pzas. Pcs.	Ship Ctn. Pzas. Pcs.	Std. Pkg. Pzas. Pcs.	Num. y calib. max. conduct. Max. No. and sze. conduct.
			mm	inch	cm ³	cu. in	kg	Lb				
OLB 	OLB-2986-C	28.01.2986.C	12.7	1/2	65.5	4.0	11.2	24.6	10	40	46	3, #8 AWG
	OLB-0088-C	28.01.0088.C	19.0	3/4	106.4	6.5	16.8	37.1	5	35	30	3, #6 AWG
	OLB-0093-C	28.01.0093.C	25.4	1	180.1	11.0	23.0	50.7	5	20	40	3, #6 AWG
	OLB-0098-C	28.01.0098.C	31.8	1 1/4	512.6	31.3	52.9	116.7	2	8	15	3, #2 AWG
	OLB-0078-C	28.01.0078.C	38.1	1 1/2	529.0	32.3	56.4	124.4	2	8	15	3, #1/0
	OLB-0306-C	28.01.0306.C	50.8	2	1195.7	73.0	114.8	253.1	1	4	6	3, #3/0
	OLB-0308-C	28.01.0308.C	63.5 S	2 1/2 S	1564.2	95.5	190.0	418.8	1	3	4	3, #2/0
	OLB-0297-C	28.01.0297.C	63.5 L	2 1/2 L	2900.0	177.0	334.0	734.8	1	-	1	3, #3/0
	OLB-0310-C	28.01.0310.C	76.2 S	3 S	1790.3	109.3	214.9	473.9	1	3	4	3, #2/0
	OLB-0298-C	28.01.0298.C	76.2 L	3 L	2900.0	177.0	295.0	649.0	1	-	1	3, #3/0
OT 	OT-2990-C	28.01.2990.C	12.7	1/2	65.5	4.0	11.5	25.3	10	40	42	3, #8 AWG
	OT-0087-C	28.01.0087.C	19.0	3/4	114.6	7.0	19.3	42.6	5	40	20	3, #6 AWG
	OT-0092-C	28.01.0092.C	25.4	1	180.1	11.0	23.0	50.76	5	20	32	3, #4 AWG
	OT-0097-C	28.01.0097.C	31.8	1 1/4	496.3	30.3	52.9	116.7	2	8	15	3, #2 AWG
	OT-0077-C	28.01.0077.C	38.1	1 1/2	512.6	31.3	65.9	145.4	2	8	15	3, #2 AWG
	OT-0307-C	28.01.0307.C	50.8	2	1126.9	68.8	108.8	240.0	1	4	6	3, #1 AWG
	OT-0309-C	28.01.0309.C	63.5 S	2 1/2 S	1528.2	93.3	186.4	411.1	1	3	4	3, #1 AWG
	OT-0301-C	28.01.0301.C	63.5 L	2 1/2 L	2800.9	170.9	353.0	776.6	1	-	1	3, #2/0
	OT-0311-C	28.01.0311.C	76.2 S	3 S	1765.7	107.8	235.4	519.1	1	3	4	3, #1 AWG
	OT-0302-C	28.01.0302.C	76.2 L	3 L	2800.9	170.9	294.5	647.9	1	-	1	3, #2/0
OC 	OC-2989-C	28.01.2989.C	12.7	1/2	65.5	4.0	10.2	22.4	10	70	63	3, #8 AWG
	OC-0330-C	28.01.0330.C	19.0	3/4	119.5	7.3	15.8	34.9	5	50	36	3, #6 AWG
	OC-0331-C	28.01.0331.C	25.4	1	185.0	11.3	21.5	47.4	5	20	46	3, #4 AWG
	OC-2625-C	28.01.2625.C	31.8	1 1/4	455.9	27.8	51.5	113.4	2	8	16	3, #2 AWG
	OC-2626-C	28.01.2626.C	38.1	1 1/2	488.7	29.8	57.0	125.5	2	8	16	3, #2 AWG
	OC-2627-C	28.01.2627.C	50.8	2	1087.3	66.3	104.5	230.0	1	4	9	3, #2/0

Especificaciones sujetas a cambio sin previo aviso. Specifications are subject to change without notice.

RAWELT, S.A. de C.V.

RAWELT® INYECTADOS
Una División del Grupo REVUELTA

1.6 - CAJA OVAL. CON TAPA. PARA TUBO RIGIDO E IMC.

Hoja: 2 / 4
Page:

1.6 - OVAL CONDUIT BODIES. WITH COVER. FOR USE WITH RIGID AND IMC CONDUIT.

FICHA TECNICA / TECHNICAL DATA

007-RW-277

USAR No. DE CODIGO PARA HACER PEDIDOS / TO ORDER USE CODE NUMBER

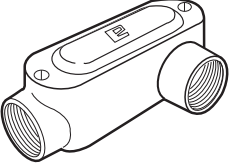
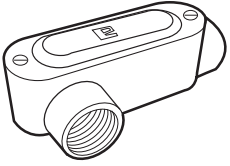
Figura Figure	Catalogo Catalog	Codigo Code	Medida nominal Hub size		Volumen Volume		Peso x 100 pzas. Weight x 100 pcs.		Unit Ctn. Pzas. Pcs.	Ship Ctn. Pzas. Pcs.	Std. Pkg. Pzas. Pcs.	Num. y calib. max. conduct. Max. No. and sze. conduct.
			mm	inch	cm ³	cu. in	kg	Lb				
	OLL-2987-C	28.01.2987.C	12.7	1/2	65.5	4.0	10.9	24.0	10	40	52	3, #8 AWG
	OLL-0089-C	28.01.0089.C	19.0	3/4	111.3	6.8	17.3	38.2	5	40	24	3, #6 AWG
	OLL-0094-C	28.01.0094.C	25.4	1	185.0	11.3	22.5	49.6	5	20	40	3, #4 AWG
	OLL-0099-C	28.01.0099.C	31.8	1 1/4	512.6	31.3	49.9	110.1	2	8	15	3, #2 AWG
	OLL-0079-C	28.01.0079.C	38.1	1 1/2	537.2	32.8	57.4	126.6	2	8	15	3, #1/0
	OLL-0323-C	28.01.0323.C	50.8	2	1208.8	73.8	122.3	269.7	1	4	6	3, #4/0
	OLL-0324-C	28.01.0324.C	63.5 S	2 1/2 S	1610.1	98.3	184.4	406.7	1	3	4	3, #4/0
	OLL-0303-C	28.01.0303.C	63.5 L	2 1/2 L	2866.5	174.9	325.5	716.1	1	-	1	3, #300 MCM
	OLL-0325-C	28.01.0325.C	76.2 S	3 S	1850.9	113.0	230.4	508.1	1	3	4	3, #4/0
	OLL-0304-C	28.01.0304.C	76.2 L	3 L	2866.5	174.9	285.5	628.1	1	-	1	3, #250 MCM
	OLR-2988-C	28.01.2988.C	12.7	1/2	65.5	4.0	10.9	24.0	10	40	52	3, #8 AWG
	OLR-0090-C	28.01.0090.C	19.0	3/4	119.5	7.3	16.8	37.1	5	40	24	3, #6 AWG
	OLR-0095-C	28.01.0095.C	25.4	1	185.0	11.3	23.0	50.7	5	20	40	3, #4 AWG
	OLR-0100-C	28.01.0100.C	31.8	1 1/4	512.6	31.3	52.4	115.6	2	8	15	3, #2 AWG
	OLR-0080-C	28.01.0080.C	38.1	1 1/2	540.5	33.0	56.9	125.5	2	8	15	3, #1/0
	OLR-0320-C	28.01.0320.C	50.8	2	1203.9	73.5	124.8	275.2	1	4	6	3, #4/0
	OLR-0321-C	28.01.0321.C	63.5 S	2 1/2 S	1577.3	96.3	188.9	416.6	1	3	4	3, #4/0
	OLR-0299-C	28.01.0299.C	63.5 L	2 1/2 L	2866.5	174.9	319.0	701.8	1	-	1	3, #300 MCM
	OLR-0322-C	28.01.0322.C	76.2 S	3 S	1850.9	113.0	230.4	508.1	1	3	4	3, #4/0
	OLR-0300-C	28.01.0300.C	76.2 L	3 L	2866.5	174.9	280.0	616.0	1	-	1	3, #250 MCM

Certificaciones / Compliances:  Expediente/File No. LR 105795-1  Expediente/File No. E135600

Especificaciones sujetas a cambio sin previo aviso.

Specifications are subject to change without notice.

RAWELT, S.A. de C.V.

RAWELT® INYECTADOS
Una División del Grupo **REVUELTA**

1.6 - CAJA OVAL. CON TAPA. PARA TUBO RIGIDO E IMC.

1.6 - OVAL CONDUIT BODIES. WITH COVER. FOR USE WITH RIGID AND IMC CONDUIT.

Hoja: 3 / 4
Page:

FICHA TECNICA / TECHNICAL DATA

007 - RW - 277

TAPA

COVER

- Lámina de aluminio troquelada.
- Tornillos galvanizados incluidos

- Sheet aluminum.
- Galvanized screws included.

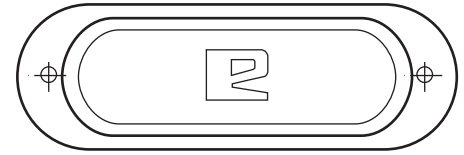

USAR No. DE CODIGO PARA HACER PEDIDOS / TO ORDER USE CODE NUMBER

Figura Figure	Catalogo Catalog	Codigo Code	Medida nominal Hub size		Espesor Thickness		Peso x 100 pzas. Weight x 100 pcs.		Paq. Unit Pzas. Pcs.	Unit. Ctn. Pzas. Pcs.	Ship. Ctn. Pzas. Pcs.	Std. Pkg. Pzas. Pcs.
			mm	inch	mm	inch	kg	Lb				
	TO-2991	28.02.2991	12.7	1/2	1.7	.067	1.8	3.9	10	60	600	1500
	TO-0356	28.02.0356	19.0	3/4	1.7	.067	2.0	4.4	10	60	600	1500
	TO-0357	28.02.0357	25.4	1	1.7	.067	2.7	5.9	10	40	400	1000
	TO-0363	28.02.0363	31.8	1 1/4	1.7	.067	5.0	11.0	10	20	200	500
	TO-0363	28.02.0363	38.1	1 1/2	1.7	.067	5.0	11.0	10	20	200	500
	TO-0373	28.02.0373	50.8	2	1.7	.067	8.5	18.7	10	40	160	300
	TO-0374	28.02.0374	63.5 S	2 1/2 S	1.7	.067	10.6	23.3	5	25	100	200
	TO-0388	28.02.0388	63.5 L	2 1/2 L	2.3	.090	20.8	45.8	5	35	100	200
	TO-0374	28.02.0374	76.2 S	3 S	1.7	.067	10.6	23.3	5	25		
	TO-0388	28.02.0388	76.2 L	3 L	2.3	.090	20.8	45.8	5	35		

Certificaciones / Compliances:



Expediente/File No. LR 105795-1



Expediente/File No. E135600

EMPAQUE

GASKET

- Material: Neopreno y Accopac.

- Material: Neoprene and Accopac.



USAR No. DE CODIGO PARA HACER PEDIDOS / TO ORDER USE CODE NUMBER

Figura Figure	Catalogo Catalog	Codigo Code	Medida nominal Hub size		Espesor Thickness		Peso x 100 pzas. Weight x 100 pcs.		Paq. Unit Pzas. Pcs.	Unit. Ctn. Pzas. Pcs.	Ship. Ctn. Pzas. Pcs.	Std. Pkg. Pzas. Pcs.
			mm	inch	mm	inch	kg	Lb				
	EO-3010	28.05.3010	12.7	1/2	1.6	1/16	1.0	2.2	100			
	EO-0372	28.05.0372	19.0	3/4	1.6	1/16	1.1	2.4	100			
	EO-0365	28.05.0365	25.4	1	1.6	1/16	1.4	3.1	100			
	EO-0370	28.05.0370	31.8	1 1/4	1.6	1/16	2.6	5.7	50			
	EO-0370	28.05.0370	38.1	1 1/2	1.6	1/16	2.6	5.7	50			
	EO-0366	28.05.0366	50.8	2	1.6	1/16	4.7	10.3	25			
	EO-0367	28.05.0367	63.5 S	2 1/2 S	1.6	1/16	5.2	11.4	10			
	EO-0431	28.05.0431	63.5 L	2 1/2 L	1.6	1/16	8.3	18.3	10			
	EO-0367	28.05.0367	76.2 S	3 S	1.6	1/16	5.2	11.4	10			
	EO-0431	28.05.0431	76.2 L	3 L	1.6	1/16	8.3	18.3	10			

Especificaciones sujetas a cambio sin previo aviso.

Specifications are subject to change without notice.

RAWELT, S.A. de C.V.

RAWELT® INYECTADOS

Una División del Grupo **REVUELTA**

1.6 - CAJA OVAL. CON TAPA. PARA TUBO RIGIDO E IMC.

Hoja: 4 / 4
Page:

1.6 - OVAL CONDUIT BODIES. WITH COVER. FOR USE WITH RIGID AND IMC CONDUIT.

FICHA TECNICA / TECHNICAL DATA
007 - RW - 277

USAR No. DE CODIGO PARA HACER PEDIDOS / TO ORDER USE CODE NUMBER

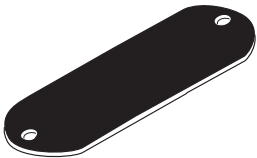
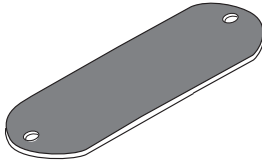
Figura Figure	Catalogo Catalog	Codigo Code	Medida nominal Hub size		Espesor Thickness		Peso x 100 pzas. Weight x 100 pcs.		Paq. Unit Pzas. Pcs.	Unit Ctn. Pzas. Pcs.	Ship Ctn. Pzas. Pcs.	Std. Pkg. Pzas. Pcs.
			mm	inch	mm	inch	kg	Lb				
 <p>NEOPRENO 0.8 NEOPRENE 1/32</p>	EO-3011	28.07.3011	12.7	1/2	0.8	1/32	0.3	0.7	100			
	EO-0528	28.07.0528	19.0	3/4	0.8	1/32	0.4	0.9	100			
	EO-0529	28.07.0529	25.4	1	0.8	1/32	0.5	1.1	100			
	EO-0530	28.07.0530	31.8	1 1/4	0.8	1/32	1.0	2.2	50			
	EO-0530	28.07.0530	38.1	1 1/2	0.8	1/32	1.0	2.2	50			
	EO-0531	28.07.0531	50.8	2	0.8	1/32	1.9	4.2	25			
	EO-0532	28.07.0532	63.5 S	2 1/2 S	0.8	1/32	2.0	4.4	10			
	EO-0533	28.07.0533	63.5 L	2 1/2 L	0.8	1/32	3.1	6.9	10			
	EO-0532	28.07.0532	76.2 S	3 S	0.8	1/32	2.0	4.4	10			
EO-0533	28.07.0533	76.2 L	3 L	0.8	1/32	3.1	6.9	10				
 <p>ACCO PAC 0.8 ACCO PAC 1/32</p>	EOA-3012	28.06.3012	12.7	1/2	0.8	1/32	0.2	0.4	100			
	EOA-0520	28.06.0520	19.0	3/4	0.8	1/32	0.2	0.4	100			
	EOA-0521	28.06.0521	25.4	1	0.8	1/32	0.3	0.6	100			
	EOA-0522	28.06.0522	31.8	1 1/4	0.8	1/32	0.6	1.3	50			
	EOA-0522	28.06.0522	38.1	1 1/2	0.8	1/32	0.6	1.3	50			
	EOA-0523	28.06.0523	50.8	2	0.8	1/32	1.0	2.2	25			
	EOA-0524	28.06.0524	63.5 S	2 1/2 S	0.8	1/32	1.2	2.6	10			
	EOA-0525	28.06.0525	63.5 L	2 1/2 L	0.8	1/32	1.7	3.7	10			
	EOA-0524	28.06.0524	76.2 S	3 S	0.8	1/32	1.2	2.6	10			
EOA-0525	28.06.0525	76.2 L	3 L	0.8	1/32	1.7	3.7	10				

TORNILLOS CAUTIVOS DE ACERO INOXIDABLE (Opcional) / CAPTIVE STAINLESS STEEL SCREWS (Optional)
Se surten en bolsa aparte / Supplied separately

USAR No. DE CODIGO PARA HACER PEDIDOS / TO ORDER USE CODE NUMBER

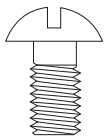
Figura Figure	Codigo Code	Medida / Size		
		Largo/Length		
		mm	inch	
 <p>TORNILLO CAUTIVO INOXIDABLE CAPTIVE STAINLESS STEEL SCREW</p>	52.05.0196.IX	TOR. # 8 - 32 NC	9.52	3/8
	52.05.0216.IX	TOR. # 12 - 24 NC	9.52	3/8
	52.05.0198.IX	TOR. 7.9 - 18 NC	15.87	5/8

Certificaciones / Compliances:  Expediente/File No. LR 105795-1

Especificaciones sujetas a cambio sin previo aviso. / Specifications are subject to change without notice.

RAWELT, S.A. de C.V.

RAWELT [®] INYECTADOS
Una División del Grupo **REVUELTA** 

1.2- CAJA OVAL. PARA TUBO RIGIDO E IMC.

DIMENSIONES.

1.2- OVAL CONDUIT BODIES. FOR USE WITH RIGID AND IMC CONDUIT.

DIMENSIONS.

SECCIONES 1.2, 1.3, 1.6

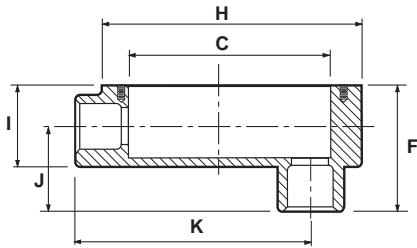

TIPO / TYPE OLB

MEDIDA SIZE		A		B		C		D		E		F		G		H		I		J		K		L			
		in	mm	in	mm	in	mm	in	mm	in	mm	in	mm	in	mm	in	mm	in	mm	in	mm	in	mm	in	mm	in	mm
12.7	1/2	4.33	110	1.32	33.5	3.23	82	1.08	27.5	3.50	89	2.05	52	8-32	4.17	3.94	100	1.38	35	1.26	32	3.58	91				
19.0	3/4	5.05	128.5	1.47	37.5	3.77	96	1.27	32.5	4.11	104.5	2.32	59	8-32	4.17	4.60	117	1.59	40.5	1.37	35	4.01	102				
25.4	1	5.76	146.5	1.77	45	4.31	109.5	1.55	39.5	4.82	122.5	2.48	63	8-32	4.17	5.37	136.5	1.77	45	1.45	37	4.64	118				
31.8	1 1/4	7.72	196	2.48	63	6.04	153.5	2.20	56	6.53	166	3.30	84	12-24	5.49	7.24	184	2.48	63	1.89	48	6.22	158				
38.1	1 1/2	7.72	196	2.48	63	6.04	153.5	2.20	56	6.53	166	3.58	91	12-24	5.49	7.26	184.5	2.65	67.5	2.12	54	6.22	158				
50.8	2	9.56	243	3.11	79	8.14	207	2.81	71.6	8.50	216	4.42	112.5	12-24	5.49	9.40	239	3.42	87	2.36	60	7.95	202				
63.5 S	2 1/2 S	10.27	261	4.23	107.5	7.63	194	3.76	95.5	8.14	207	5.21	132.5	5/16	7.93	9.33	237	3.74	95	3.22	82	7.67	195				
76.2 S	3 S	10.27	261	4.21	107	7.63	194	3.77	96	8.14	207	6.02	153	5/16	7.93	9.33	237	4.37	111	3.74	95	7.55	192				
63.5 L	2 1/2 L	13.07	332	4.60	117	10.47	266	4.13	105	11.25	286	5.98	152	5/16	7.93	12.32	313	4.52	115	3.54	90	10.59	269				
76.2 L	3 L	13.07	332	4.60	117	10.47	266	4.13	105	11.25	286	5.98	152	5/16	7.93	12.32	313	4.52	115	3.54	90	10.59	269				

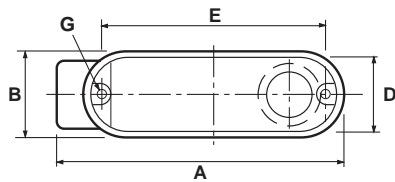

TIPO / TYPE OT

MEDIDA SIZE		A		B		C		D		E		F		G		H		I		J		K		L			
		in	mm	in	mm	in	mm	in	mm	in	mm	in	mm	in	mm	in	mm	in	mm	in	mm	in	mm	in	mm	in	mm
12.7	1/2	4.76	121	1.32	33.5	3.23	82	1.08	27.5	3.50	89	1.99	50.5	8-32	4.17	3.90	99	1.38	35	1.34	34	2.38	60.5				
19.0	3/4	5.43	138	1.47	37.5	3.74	95	1.27	32.5	4.09	104	2.28	58	8-32	4.17	4.58	116.5	1.61	41	1.53	39	2.71	69				
25.4	1	6.14	156	1.77	45	4.33	110	1.57	40	4.82	122.5	2.53	64.5	8-32	4.17	5.35	136	1.75	44.5	1.61	41	3.07	78				
31.8	1 1/4	8.22	209	2.48	63	5.96	151.5	2.20	56	6.53	166	3.44	87.5	12-24	5.49	7.26	184.5	2.71	69	2.16	55	4.11	104.5				
38.1	1 1/2	8.22	209	2.48	63	5.94	151	2.20	56	6.53	166	3.44	87.5	12-24	5.49	7.28	185	2.69	68.5	2.16	55	4.11	104.5				
50.8	2	9.92	252	3.13	79.5	7.63	194	2.82	71.8	8.52	216.5	4.46	113.5	12-24	5.49	9.42	239.5	3.44	87.5	2.44	62	4.96	126				
63.5 S	2 1/2 S	11.18	284	4.15	106.5	7.61	193.5	3.74	95	8.11	206	5.74	146	5/16	7.93	9.25	235	3.74	95	3.58	91	5.59	142				
76.2 S	3 S	11.02	280	4.21	107	7.14	181.5	3.76	95.5	8.07	205	5.90	150	5/16	7.93	9.29	236	4.33	110	3.74	95	5.51	140				
63.5 L	2 1/2 L	13.81	351	4.60	117	10.31	262	4.13	105	11.29	287	5.82	148	5/16	7.93	12.30	312.5	4.52	115	3.50	89	6.88	175				
76.2 L	3 L	13.81	351	4.60	117	10.31	262	4.13	105	11.29	287	5.82	148	5/16	7.93	12.30	312.5	4.52	115	3.50	89	6.88	175				

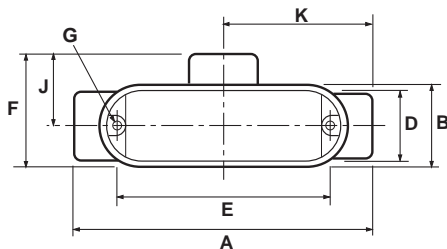
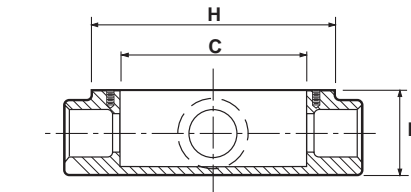

1.2- CAJA OVAL. PARA TUBO RIGIDO E IMC. DIMENSIONES.

1.2- OVAL CONDUIT BODIES. FOR USE WITH RIGID AND IMC CONDUIT. DIMENSIONS.

SECCIONES 1.2, 1.3, 1.6

FICHA TECNICA / TECHNICAL DATA

007-RW-271

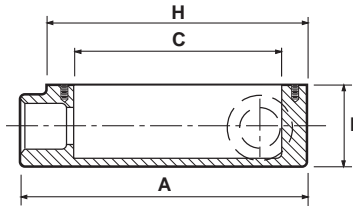

TIPO / TYPE OLL

MEDIDA SIZE		A		B		C		D		E		F		G		H		I		J		K		L			
		in	mm	in	mm	in	mm	in	mm	in	mm	in	mm	in	mm	in	mm	in	mm	in	mm	in	mm	in	mm	in	mm
12.7	1/2	4.33	110	1.32	33.5	3.23	82	1.08	27.5	3.50	89	1.99	50.5	8-32	4.17	3.90	99	1.38	35	1.34	34	3.38	86				
19.0	3/4	5.0	127	1.49	38	3.72	94.5	1.29	33	4.09	104	2.24	57	8-32	4.17	4.60	117	1.59	40.5	1.51	38.5	3.89	99				
25.4	1	5.74	146	1.77	45	4.25	108	1.57	40	4.82	122.5	1.77	45	8-32	4.17	5.37	136.5	1.77	45	1.61	41	4.60	117				
31.8	1 1/4	7.71	196	2.46	62.5	6.08	154.5	2.18	55.5	6.57	167	3.28	83.5	12-24	5.49	7.26	184.5	2.46	62.5	2.04	52	6.14	156				
38.1	1 1/2	7.71	196	2.46	62.5	6.02	153	2.18	55.5	6.53	166	3.28	83.5	12-24	5.49	7.26	184.5	2.65	67.5	2.04	52	6.25	159				
50.8	2	9.74	247.5	3.12	79.5	7.87	200	2.83	72	8.54	217	4.09	104	12-24	5.49	9.44	240	3.48	88.5	2.46	62.5	7.51	191				
63.5 S	2 1/2 S	10.39	264	4.27	108.5	7.63	194	3.74	95	8.14	207	5.84	148.5	5/16	7.93	9.35	237.5	3.70	94	3.62	92	7.63	194				
76.2 S	3 S	10.39	264	4.64	118	7.59	193	3.75	95.5	8.14	207	5.90	150	5/16	7.93	9.35	237.5	4.37	111	3.75	95.5	7.59	193				
63.5 L	2 1/2 L	13.07	332	4.60	117	10.43	265	4.13	105	11.25	286	5.82	148	5/16	7.93	12.32	313	4.48	114	3.50	89	10.55	268				
76.2 L	3 L	13.07	332	4.60	117	10.43	265	4.13	105	11.25	286	5.82	148	5/16	7.93	12.32	313	4.48	114	3.50	89	10.55	268				

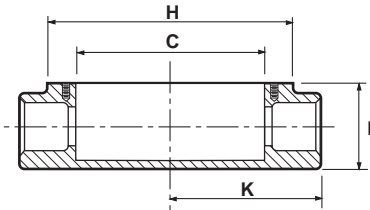
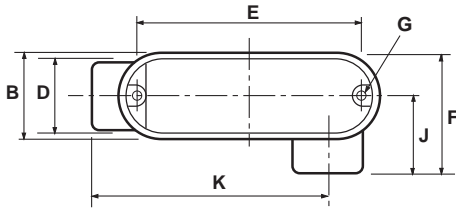

TIPO / TYPE OC

MEDIDA SIZE		A		B		C		D		E		F		G		H		I		J		K		L			
		in	mm	in	mm	in	mm	in	mm	in	mm	in	mm	in	mm	in	mm	in	mm	in	mm	in	mm	in	mm	in	mm
12.7	1/2	4.76	121	1.32	33.5	3.23	82	1.08	27.5	3.50	89			8-32	4.17	3.90	99	1.38	35			2.38	60.5				
19.0	3/4	5.39	137	1.49	38	3.72	94.5	1.27	32.5	4.09	104			8-32	4.17	4.60	117	1.57	40			2.69	68.5				
25.4	1	6.14	156	1.79	45.5	4.29	109	1.57	40	4.82	122.5			8-32	4.17	5.39	137	1.77	45			3.07	78				
31.8	1 1/4	8.22	209	2.46	62.5	5.96	151.5	2.18	55.5	6.53	166			12-24	5.49	7.26	184.5	2.46	62.5			4.11	104.5				
38.1	1 1/2	8.22	209	2.46	62.5	5.96	151.5	2.18	55.5	6.53	166			12-24	5.49	7.26	184.5	2.65	67.5			4.11	104.5				
50.8	2	9.92	252	3.12	79.5	7.63	194	2.83	72	8.54	217			12-24	5.49	9.44	240	3.48	88.5			4.96	126				

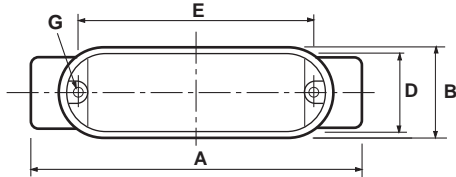

RAWELT, S.A. de C.V.

RAWELT © INYECTADOS
Una División del Grupo REVUELTA

1.2- CAJA OVAL. PARA TUBO RIGIDO E IMC. DIMENSIONES.

1.2- OVAL CONDUIT BODIES. FOR USE WITH RIGID AND IMC CONDUIT. DIMENSIONS.

TIPO / TYPE **OLR**

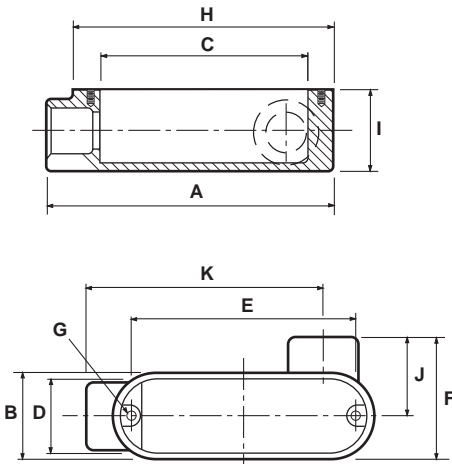

MEDIDA SIZE		A		B		C		D		E		F		G		H		I		J		K		L	
		in	mm	in	mm	in	mm	in	mm	in	mm	in	mm	in	mm	in	mm	in	mm	in	mm	in	mm	in	mm
12.7	1 / 2	4.33	110	1.32	33.5	3.23	82	1.08	27.5	3.50	89	1.99	50.5	8-32	4.17	3.90	99	1.38	35	1.34	34	3.38	86		
19.0	3 / 4	5.0	127	1.47	37.5	3.70	94	1.27	32.5	4.07	103.5	2.26	57.5	8-32	4.17	4.60	117	1.59	40.5	1.51	38.5	3.89	99		
25.4	1	5.74	146	1.77	45	4.25	108	1.57	40	4.82	122.5	2.51	64	8-32	4.17	5.37	136.5	1.77	45	1.63	41.5	4.60	117		
31.8	1 1/4	7.83	199	2.48	63	6.02	153	2.20	56	6.57	167	3.30	84	12-24	5.49	7.26	184.5	2.48	63	2.10	53.5	6.25	159		
38.1	1 1/2	7.75	197	2.48	63	6.02	153	2.20	56	6.53	166	3.30	84	12-24	5.49	7.26	184.5	2.65	67.5	2.04	52	6.25	159		
50.8	2	9.70	246.5	3.13	79.5	8.14	207	2.83	72	8.54	217	4.05	103	12-24	5.49	9.44	240	3.46	88	2.40	61	7.51	191		
63.5 S	2 1/2 S	10.39	264	4.25	108	7.63	194	3.74	95	8.14	207	5.78	147	5/16	7.93	9.33	237	3.74	95	3.62	92	7.63	194		
76.2 S	3 S	10.39	264	4.25	108	7.63	194	3.74	95	8.14	207	5.96	151.5	5/16	7.93	9.35	237.5	4.44	113	3.81	97	7.59	193		
63.5 L	2 1/2 L	13.03	331	4.62	117.5	10.51	267	4.13	105	11.27	286.5	5.82	148	5/16	7.93	12.32	313	4.48	114	3.50	89	10.55	268		
76.2 L	3 L	13.03	331	4.62	117.5	10.51	267	4.13	105	11.27	286.5	5.82	148	5/16	7.93	12.32	313	4.48	114	3.50	89	10.55	268		

Cotización/Quotation Plazo de embarque* / Shipment exw*

Pedido No./Purchase order :

Our ref.:

Fecha/Date: Vendedor/Salesman: No.

Facturar a/Invoice to: RFC.

Ordenado por/Ordered by: Tel. () Fax ()

Dirección/Address:









C.P./Zip: Lugar/City/Country:

Consignar a/Ship to:

Embarcar: Camión x Cobrar Pagado Paquete

Cond. de Pago/Terms:

Cond. de Venta/Sale conditions: L.P.:

1.6 - SERIE OVAL. ROSCADA CON TAPA/THREADED WITH COVER						TAPA/COVER	EMPAQUE/GASKET		
Cantidad piezas									
	LB	OT	OC	LL	LR	TO	Neopreno Neoprene 1/16	Neopreno Neoprene 1/32	Accopac 1/32
Std. Pkg Pzas.	Código: 28.01.XXXX.C					28.02	28.05.	28.07.	28.06.
12.7 1/2	46 2986.C	42 2990.C	63 2989.C	52 2987.C	52 2988.C	10 2991	100 3010	100 3011	100 3012
19.0 3/4	30 0088.C	20 0087.C	36 0330.C	24 0089.C	24 0090.C	10 0356	100 0372	100 0528	100 0520
25.4 1	40 0093.C	32 0092.C	46 0331.C	40 0094.C	40 0095.C	10 0357	100 0365	100 0529	100 0521
31.8 1 1/4	15 0098.C	15 0097.C	16 2625.C	15 0099.C	15 0100.C	10 0363	50 0370	50 0530	50 0522
38.1 1 1/2	15 0078.C	15 0077.C	16 2626.C	15 0079.C	15 0080.C	10 0363	50 0370	50 0530	50 0522
50.8 2	6 0306.C	6 0307.C	9 2627.C	6 0323.C	6 0320.C	10 0373	25 0366	25 0531	25 0523
63.5 S* 2 1/2 S*	4 0308.C	4 0309.C		4 0324.C	4 0321.C	5 0374	10 0367	10 0532	10 0524
63.5 L** 2 1/2 L**	1 0297.C	1 0301.C		1 0303.C	1 0299.C	5 0388	10 0431	10 0533	10 0525
76.2 S* 3 S*	4 0310.C	4 0311.C		4 0325.C	4 0322.C	5 0374	10 0367	10 0532	10 0524
76.2 L** 3 L**	1 0298.C	1 0302.C		1 0304.C	1 0300.C	5 0388	10 0431	10 0533	10 0525

Expediente
 Control
 Embarques
 Almacén
 Producción

* S: Corto/Short ** L: Largo/Large

- Antes de fincar el pedido en firme, favor de confirmar con fábrica el plazo de embarque definitivo.
- Before place your order, please confirm with RAWELT definitive date of shipment.