

PORTEO

PORTEO – the small swing door operator from dormakaba

The PORTEO offers a convenient way to open doors effortlessly and to close them automatically. With all the elegance of the dormakaba Contur design, the PORTEO is specifically suited to light doors, performing all the functions needed to make life just that little bit easier for all.

High-quality dormakaba technology makes the PORTEO particularly easy to operate – with minimum noise, high functional reliability and excellent application adaptability. The PORTEO is delivered ready-to-connect and offers much comfort and safety in conjunction with fast mounting thanks to its Plug & Go feature. The system is delivered as complete package with slide channel and mounting plate. The PORTEO can be further functionalised with original dormakaba system accessories to give even more operating convenience, user-friendliness and enhanced safety. In combination with an optional pushbutton and an electric strike, for example, the door can be simply opened with the push of a button. Use the hand-held transmitter „BRC-H“ for even more convenient opening and closing. The PORTEO is the application for opening and closing doors the convenient way. Safe, reliable and easy to upgrade.

Certified to ISO 9001

Benefits point by point

- Easy opening and closing of swing doors up to widths of 1100 mm and door-leaf weights of up to 100 kg
- One version for all four ways of mounting: hinge and opposite hinge side, lintel mounting or door-leaf mounting. Compact dimensions 60x530x80 mm (HxWxD), particularly suitable for use in conjunction with narrow-stile and standard profile door systems
- Extremely low installation height of just 60 mm
- Quiet operation
- Easy installation thanks to ready-to-connect Plug & Go function with mounting plate
- GGT-approved

Fields of application

Interior doors, single-leaf

Door-leaf width	≤1100 mm
Door-leaf weight, max.	100 kg

Technical specifications

Lintel mounting/door-leaf mounting on hinge side/opposite hinge side	●
Non-handed	●
Latching action (de-/activatable)	●
Dimensions H x W x D	60 x 530 x 80 mm
Weight	3.2 kg
Supply voltage	230 V AC, 50/60 Hz
Power supply for external accessories	24 V DC, 300 mA
Class of protection	IP 20
Low-Energy-Function	●
Compliant with DIN 18650 and EN 16005	●
GS mark, TÜV type-approved	●

Adjustable parameters

Adjustable opening time (0° – 90°)	5 to 10 sec.
Adjustable closing time (90° – 0°)	5 to 10 sec.
Adjustable hold-open time	5 to 10 sec.*
Adjustable opening angle, max.	110°

Standard function programs

Power Assist Mode	●
Push & Go	●
Automatic Mode	●
Permanent Open	●
Obstruction recognition	●
Anti-vandalism feature (deactivation of gear)	●

Prepared for following accessories

Electric strike	●
Hand-held transmitter	○
Pushbutton	○
Safety sensors	○





● Standard ○ Option * in Power Assist Mode 0.5 to 30 sec.

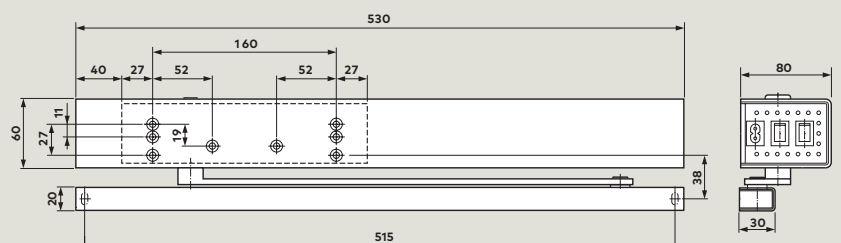

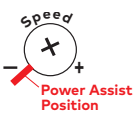

reddot design award
winner 2005

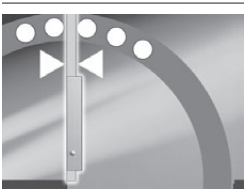

Functions

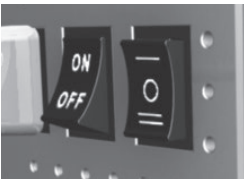
Operating mode	Door equipment	Settings	
		Program switch	Potentiometer
 <p>Power Assist Mode Drive-supported manual door opening. The door closes automatically on expiry of the individually adjusted hold-open time.</p>	<ul style="list-style-type: none"> – Standard locking device – Lever handle 	I	<p>1</p> 
 <p>Push & Go Once the door is opened manually by 3°, the automatic door opening function is triggered. The PORTEO then closes the door again automatically after the adjusted hold-open time.</p>	<ul style="list-style-type: none"> – Standard locking device – Lever handle 	I	<p>1</p>  <p>Adjustable opening and closing time. Original setting 10 sec. (max.)</p>
 <p>Automatic Mode Automatic opening and closing of door in combination with electric strikes and external activators such as the BRC-H hand-held transmitter. As soon as the signal is transmitted and the electric strike is released, the door automatically opens and then closes again on expiry of the adjusted hold-open time.</p>	<ul style="list-style-type: none"> – Standard locking device – Electric strike – External activator 	I	<p>2</p>  <p>Adjustable hold-open time adjustable</p>
 <p>Permanent Open This function is designed to keep the door permanently open. The door opens and is held in this position until another signal is triggered for example by the program switch (the locking device must be unlocked) or by a double-click on the hand-held transmitter (flip-flop-function).</p>		II	

Program switch modes	Switch position	Function
	0	OFF
	I	Automatic
	II	Permanent Open

Max. permissible door widths and weights

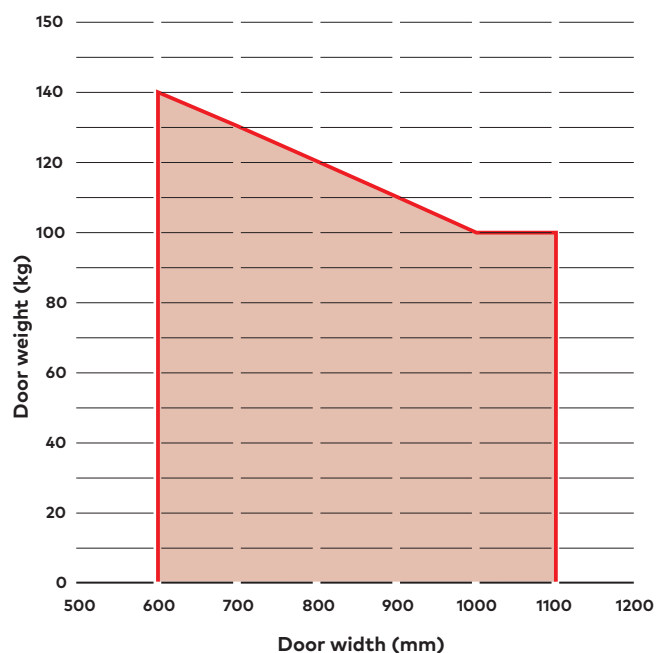

Lintel mounting

Lintel mounting on hinge side

(Example refers to left-handed (ISO 6) door; mirror image applies to right-handed (ISO 5) door)

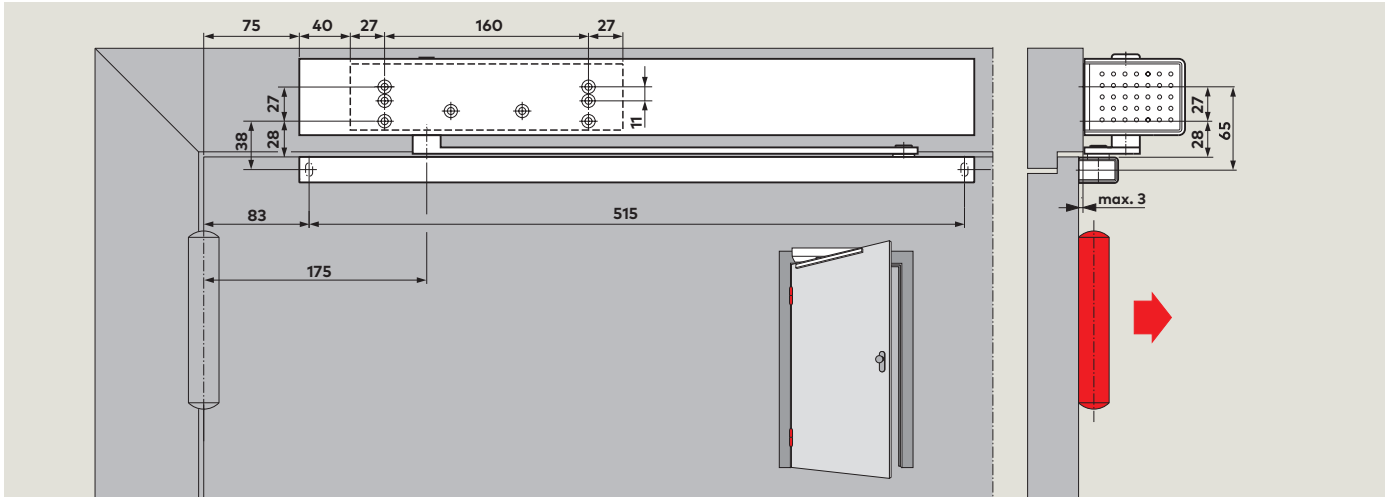

Lintel-mounting on opposite hinge side

(Example refers to left-handed (ISO 6) door; mirror image applies to right-handed (ISO 5) door)

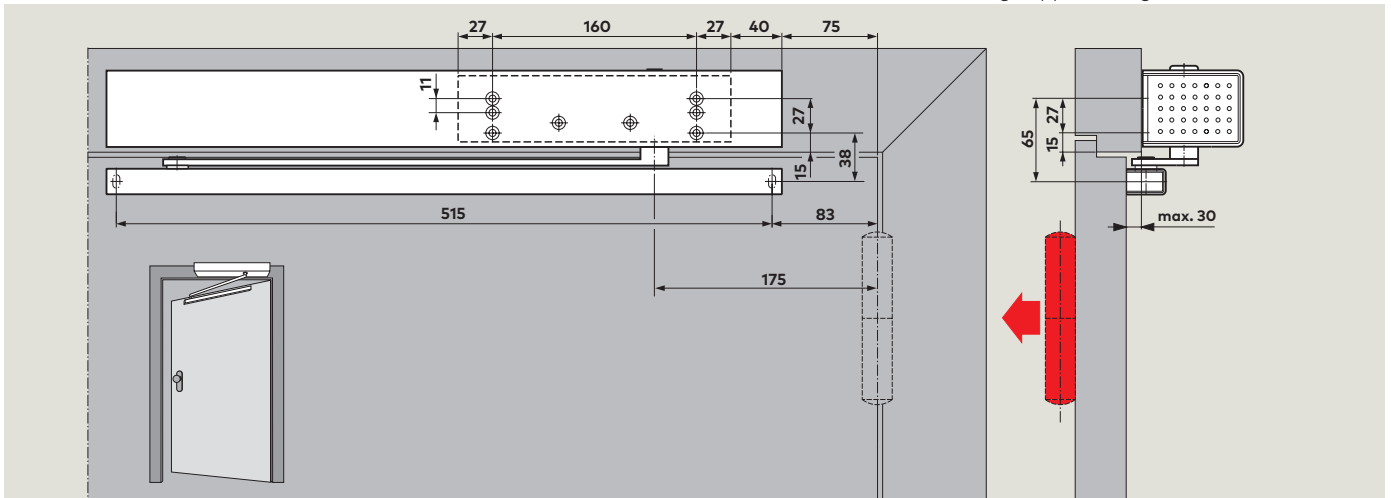

Plug & Go Mains connection via power plug

(Example refers to left-handed (ISO 6) door; mirror image applies to right-handed (ISO 5) door)

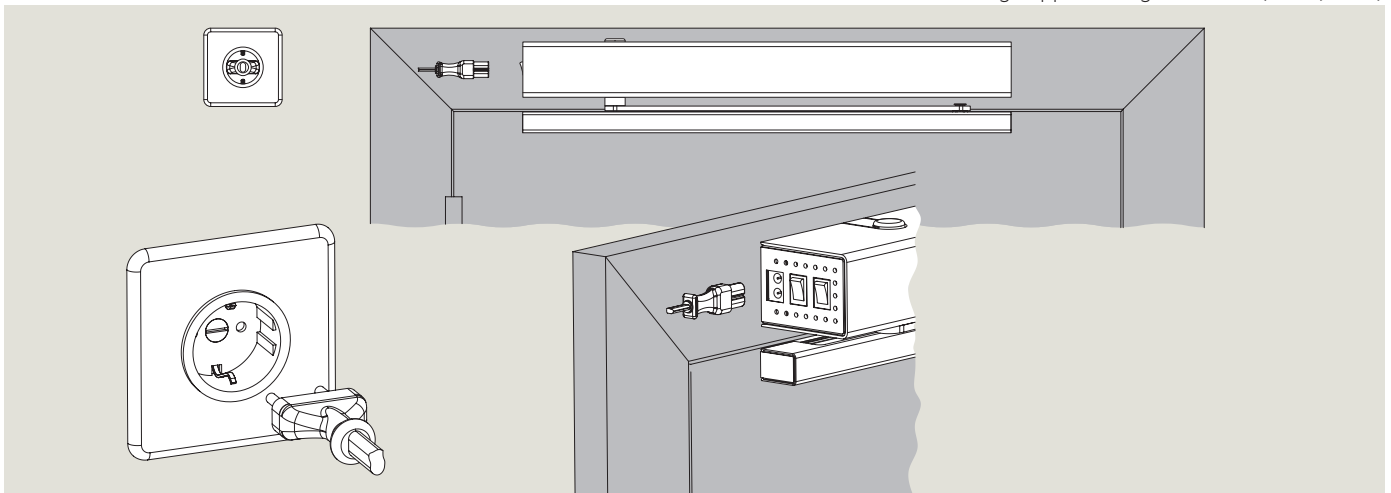

Door-leaf mounting

Door-leaf mounting on hinge side

(Example refers to left-handed (ISO 6) door; mirror image applies to right-handed (ISO 5) door)

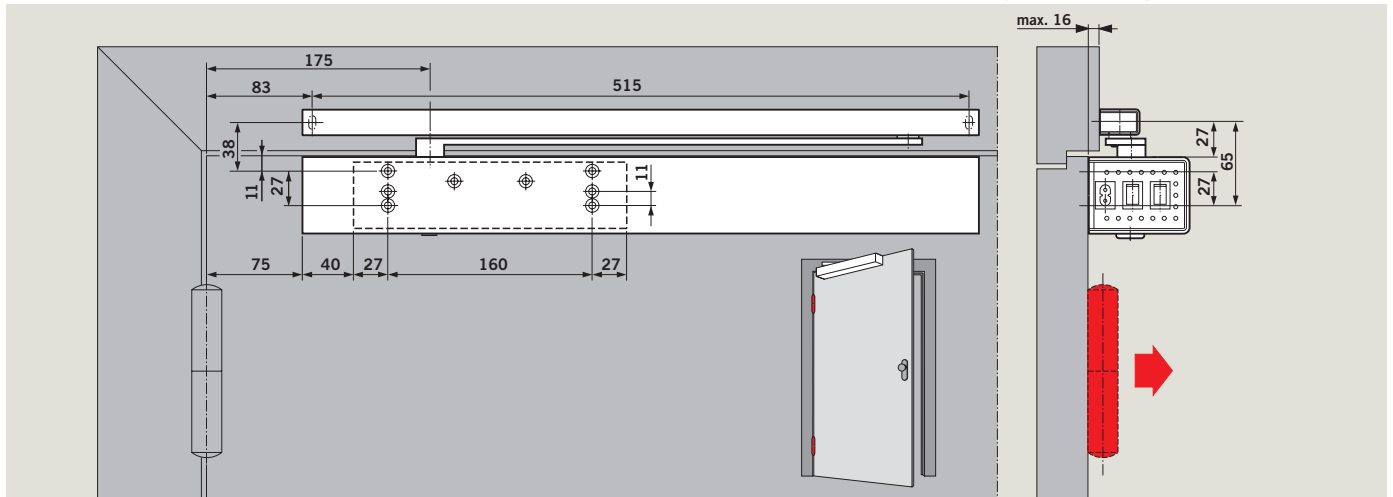

Door-leaf mounting on opposite hinge side

(Example refers to left-handed (ISO 6) door; mirror image applies to right-handed (ISO 5) door)

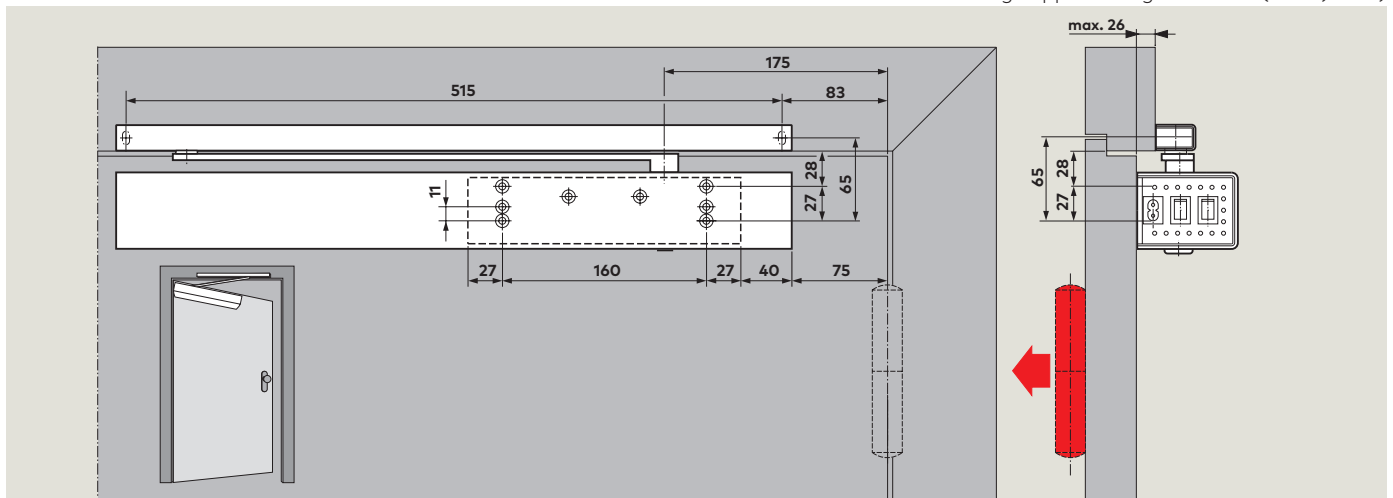

Wiring diagram

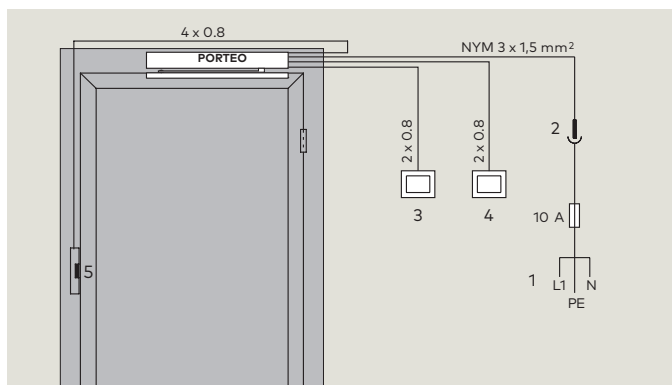

- 1 Permanent power supply line
- 2 Two-pole-and-earth socket
- 3 Internal pushbutton

- 4 External pushbutton
- 5 Electric strike

Type 500 flexible cable loop

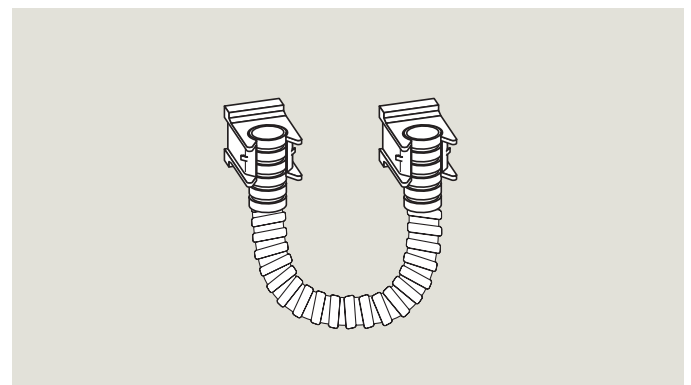

The safe and reliable solution from for protecting the cables required for door-leaf mounting.

Accessories

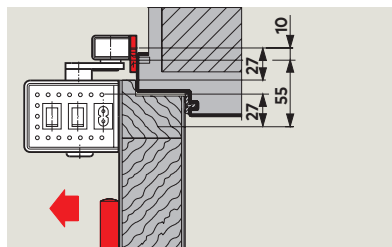

Mounting plate 30 mm or 40 mm

For mounting of slide channel at door frames where no direct installation is possible.

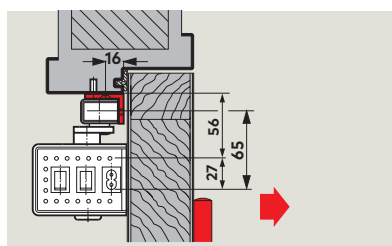
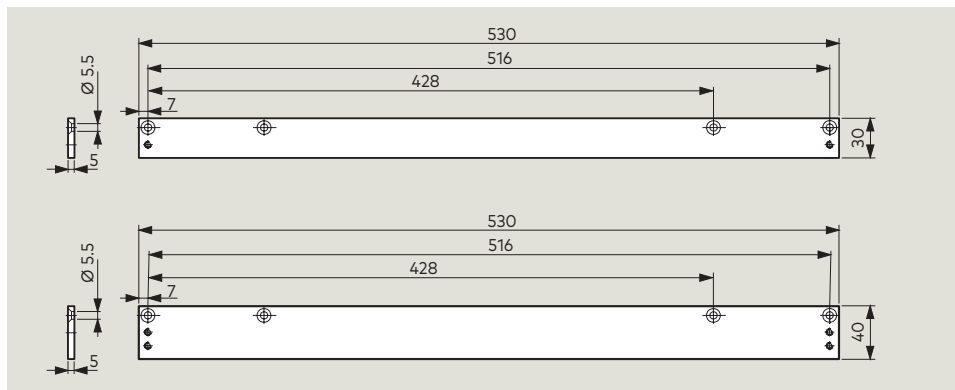

Angle bracket

For mounting of slide channel at door frames with a deep lintel and mounting on the opposite hinge side. For lintel depths from -20 to +200 mm with optional standard arm.

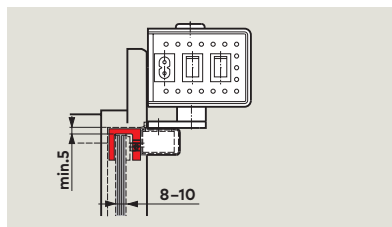
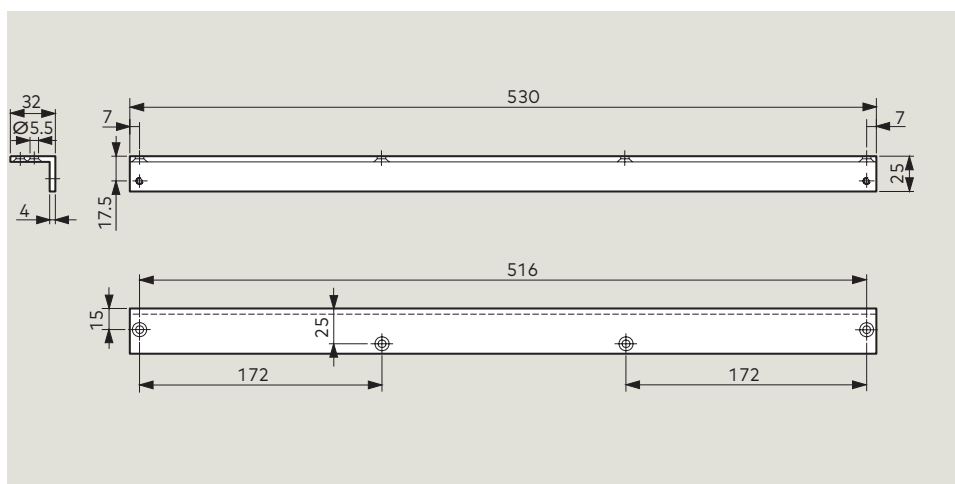

Shoe clip

For mounting the slide channel at full-glass doors – no glass machining necessary. Lintel mounting on the hinge side only.

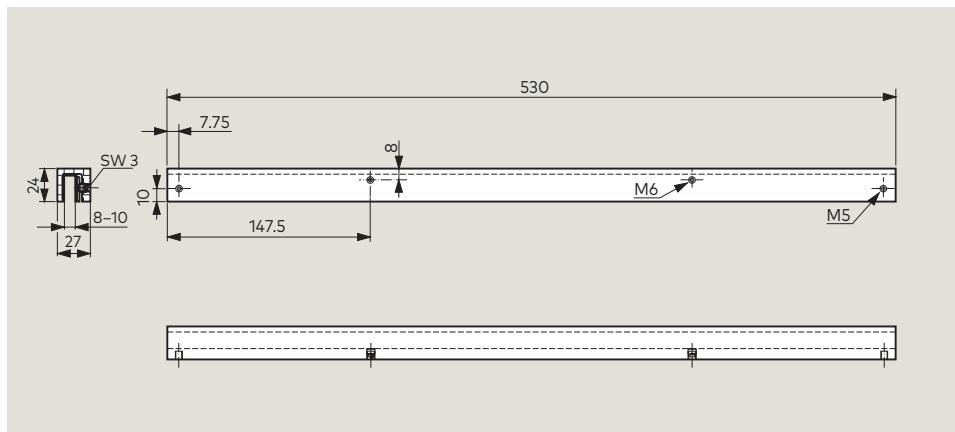

Optional activators, radio receivers

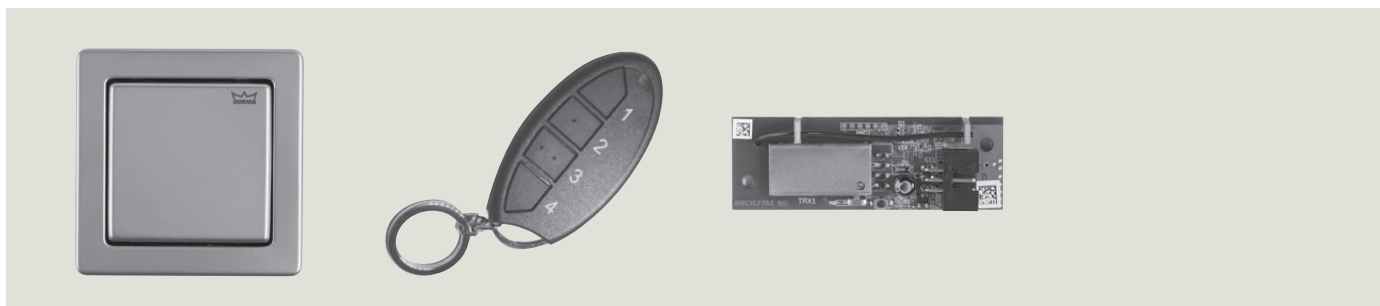







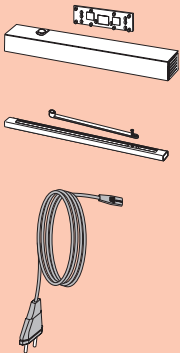

Manual pushbutton, System 55

Radio hand-held transmitter BRC-H

Radio receiver BRC-R

Standard equipment and accessories

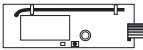
PORTEO 230 V	Angle bracket	Mounting plate 30 mm	Mounting plate 40 mm	Shoe clip	Flexible cable loop type 500
					
600410xx	600411xx	600412xx	600413xx		60041401
				Pushbutton System 55	Radio hand-held transmitter DORMA atent
					
600100xx				19144701170	Radio receiver BRC-R 
				60041500	29302002

xx Colour

01	Silver-coloured
11	White (sim. to RAL 9016)

Specification text

Electro-mechanical swing door operator operating in Low-Energy-Function (force limitation) to DIN 18650 and EN 16005, including slide channel and mounting plate in dormakaba Contur design.

Operating options: Power Assist Mode or Automatic Mode. Opening and closing speeds, hold-open time and opening angle adjustable.

Latching action as standard. Non-handed. Mounting plate with universal fixing hole pattern. For lintel mounting or door-leaf mounting on the hinge or opposite hinge side.

Door parameters

- Single-leaf interior doors, not suitable for fire and smoke doors
- Door-leaf widths: max. 1100 mm (depending on door weight)
- Door-leaf weight per leaf: max. 140 kg (depending on door width)
- Opening angle per door leaf: min. 100° for all ways of mounting
- Operator dimensions: 60 mm x 530 x 80 mm (H x W x D)
- Adjustable operating modes via program switch (O I II):
O = OFF,
I = Automatic Mode
II = Permanent Open
- Extended function programs:
 - Power Assist Mode
 - Push & Go
 - Supply voltage: 230 V AC, 50/60 Hz

Version

- Complete package including slide channel and mounting plate suitable for all four ways of mounting

Colour

- Silver-coloured
- White, sim. to RAL 9016

Electric strike

- Option: electric strike in fail-secure design (locked while de-energised)
- Option: electric strike in fail-safe design (open while de-energised)

Activator

- Option: pushbutton, Type:
- Option: hand-held transmitter, Type:
- Option: receiver for hand-held transmitter, Type:

Tested according to the guidelines for power-operated windows, doors and gates, BGR 232 (German Employer's Liability Insurance Association Rule), DIN 18650 and EN 16005-1/2 (German Industrial Standard), GS-mark (TÜV type-approval) and the German guidelines of the Association for Electrical, Electronic & Information Technologies, latest version in each case. Manufactured to ISO 9001.

Make

PORTEO



www.dormakaba.com

dormakaba Deutschland GmbH
DORMA Platz 1
58256 ENNEPETAL
Germany
T: +49 2333 793-0
F: +49 2333 793-4950

WN 053 306 51532, 03/17, PORTEO, GB, x, DMS: xx/12
Subject to change without notice.