

User Manual

X-Ray Inspection System

Applicable Models: ZKX series

Version: 3.0

Date: Jan, 2018

Statement

Statement of Rights and Responsibilities

All rights reserved by ZKTECO CO.,LTD. and under the protection of relative Laws of People Republic of China. No person shall use the trademark without the express written permission of the company, no person may copy or spread this manual.

- 1) We are not responsible for breakdown caused by improper operation.
- 2) Due to product updates frequently, this manual may have differences from the actual product, please prevail in kind.
- 3) We will not announce any further notice when we update the user manual.

Radiation Protection Statement

- 1) ZKX series X-ray inspection system meet the criterion of international and domestic radiation safety standard, it is harmless for human and environment.
- 2) ZKX series X-ray inspection system ensure ISO1600 (33DIN) Film safety.

Contact

Company: ZKTECO CO., LTD.

Address: ZKTeco Industrial park,188 Industrial Avenue, PingShan, TangXia town Dongguan, Guangdong province, China.

ZKTeco Building, Wuhe road, BanTian, LongGang district, Shenzhen.

Website: www.zkteco.com

E-mail: marketing@zkteco.com

Foreword

Dear customers, thank you for choosing our company's X-ray inspection system. This manual will give instruction of operation safety, production instruction, image reading, menu option, FAQ. By this manual, you will learn how to operate, adjust and maintain this product, follows the international safety standards of X-ray equipment. Thus, it is absolutely safe for operator and environment.

Purpose

This manual could help operator correctly operate our company's X-ray inspection system. Before you start, we strongly suggest you read this manual carefully.

Applications

This manual is applicable to:

- 1) Operator
- 2) Administrator
- 3) Technician

Contents

Chapter 1 Safe Operation Notice	1
1.1 Films Safety.....	1
1.2 Safety Check Before Power On.....	1
1.3 Basic Safe Rules.....	1
1.4 Radiation Protection.....	2
Chapter 2 Product Introduction.....	3
2.1 Working Principle	3
2.2 Product Technical Indicators / Basic Parameters	4
2.3 Product Features.....	6
2.4 The Main Purpose and Application.....	6
Chapter 3 Equipment Operation and Description	7
3.1 Turn-on.....	7
3.2 Item Inspection	8
3.3 Shut Down.....	9
3.4 Indicator and Emergency Stop Button	9
3.5 Special Keyboard.....	11
3.6 PC keyboard and mouse	14
Chapter 4 Image Processing and Software Operation Guide	16
4.1 Main Interface	16
4.2 System Software.....	16
4.3 Information Area.....	17
4.4 Operating function area.....	18
4.5 Image Processing Function.....	19
4.5.1 BW/CL(Black&White  Color)	19
4.5.2 HP (High Penetrate)	20
4.5.3 LP(Low Penetrate)	20
4.5.4 PV(Perfect View).....	20
4.5.5 OM(Organic Material).....	21
4.5.6 IM(Inorganic Material).....	21
4.5.7 IN(Inversing)	22
4.5.8 Brightening/Decrease (Changes of Absorptivity)	22
4.5.9 DS(Dynamic Scan)	23
4.5.10 PS(Pseudo-color Display).....	23
4.5.11 Suspicious Organics Enhancing of Z789.....	23
4.6 System Options	23

4.7 Image	24
4.7.1 Image Preview	24
4.7.2 Image Setting.....	26
4.8 User Management.....	27
4.8.1 Account Setting.....	28
4.8.2 Change Password.....	29
4.8.3 Automatic Login.....	29
4.9 Log Management	30
4.9.1 Startup Log.....	30
4.9.2 Session Log.....	31
4.9.3 X-ray Radiation Log	31
4.10 TIP(Threat Image Projection)	32
4.10.1 TIP Strategy	33
4.10.2 TIP Images.....	35
4.10.3 TIP Exam Query	35
4.11 Training.....	36
4.11.1 Parameters Setting.....	36
4.11.2 Operation Panel.....	37
4.11.3 Training Procedure.....	37
4.12 System Settings.....	37
4.12.1 Intelligent Identification	37
4.12.2 Keyboard	38
4.12.3 Counter Setting.....	39
4.12.4 Others.....	40
4.13 System information.....	41
4.14 Log out and shutdown.....	41
Chapter 5 Daily Maintenance	42
5.1 Matters Needing Attention on Maintenance	42
5.2 Daily Cleaning	42
5.2.1 Outer Surface of the Equipment	42
5.2.2 The Interior of the Equipment.....	43
5.2.3 Display, the Hole Site of Photoelectric Sensor and Control Console.....	43
5.3 Regular Check.....	43
5.3.1 Photoelectric Sensor	44
5.3.2 Inspect the Conveyor.....	44
5.3.3 Inspect the Lead Curtain at the Entrance and Exit of the Passage	44
5.3.4 Inspect X-ray Indicator Light and Power Indicator Light.....	44

5.3.5 Inspect the Emergency Stop Button	44
5.4 Storage Conditions and Notice.....	44
5.5 Common Failures and Trouble-shooting.....	45
Failure 1: The equipment won't boot normally by pressing the start button.....	45
Failure 2: The conveyor belt won't run.....	46
Failure 3: The screen displays "System self-inspection error"	46
Failure 4: Keys on the special-purpose keyboard won't work normally	47
Failure 5: The ray won't radiate normally	47
Failure 6: Illegal power failure	47

Chapter 1 Safe Operation Notice

Based on ensuring that the X-Ray Inspection system is used in the user's safety regulations, we recommend that the operator read the manual before starting.

1.1 Films Safety

Our company's X-Ray Inspection system are safety for ISO1600 standard film.

1.2 Safety Check Before Power On

For X-Ray Inspection system before the power is turned on, make sure to carry out the following safety checks:

- 1) Check the lead film, do not start the system if there is broken or gap.
- 2) Check if photoelectric sensor are blocked.
- 3) Check if transmission belt deviate or stuck, ensure there is no spike or filth.
- 4) Check if there has flaw on the shell, monitor, console board and cable.
- 5) Ensure the cover plate is properly installed.

1.3 Basic Safe Rules

For safely use X-ray inspection system, please follow the following rules:

- 1) You should know relevant radiation protection rules.
- 2) The operator must know all safety instruction and rules.
- 3) If you had not used it for more than 6 months, please check it carefully before start up.
- 4) The installation, circuit connection and replacement of electrical components only could finish by professional technician.
- 5) If shell, cable or transmission belt are broken, no operation shall be allowed.
- 6) Only professional technician could open shell and inner parts.
- 7) Do not modify or change any safety settings.
- 8) No living things shall be allowed to go in X-ray inspection system.
- 9) Do not dip any part of body into tunnel when system is running.
- 10) Immediately shut down if liquid flow into the system.
- 11) All circuit connection and ground connection have to be completely correct.

1.4 Radiation Protection

We take reliable radiation protection measures on our product to ensure the safety of operator and users, which are:

- 1) Only when generator is under high voltage, will device emit X-ray. Therefore, it would not generate radiation in transport and stock.
- 2) Lead boards are installed around the machine, entrance and exit have lead film, prevent X-ray from leaking into the environment.
- 3) Device has effective ground connection, prevent operators from electric shock.
- 4) The overload preventer, overcurrent preventer and current leakage preventer are installed inside the device.
- 5) A safe interlock is installed, if any interlock switch off, the X-ray generator would not be activated.

Chapter 2 Product Introduction

2.1 Working Principle

X-ray inspection system has five parts: Item transmission part, X-ray generator & control, Signal acquisition & transmission, Industrial motherboards and electric control.

Items enter X-ray inspect tunnel by conveyor belt, photoelectric sensor was installed at the entrance. When items go into the tunnel, the sensor would deliver an inspect action signal. Then control board controls the X-ray generator to generate the X-ray. The X-ray would penetrate items and partly absorbed by items, X-ray receiver would receive rest of X-ray. Then receiver transforms the X-ray into digital signal and send it to computer. With the superb image algorithm, clear image of item would display on the screen.

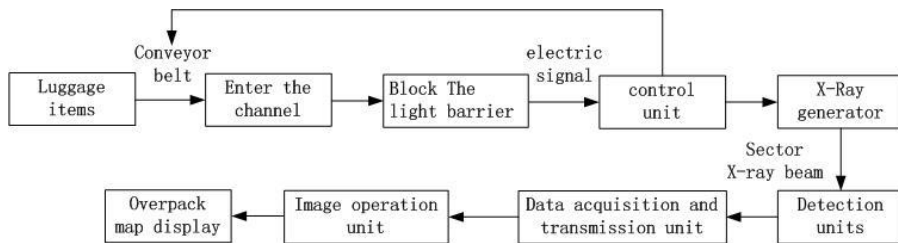

Figure2-1 System Operation Process

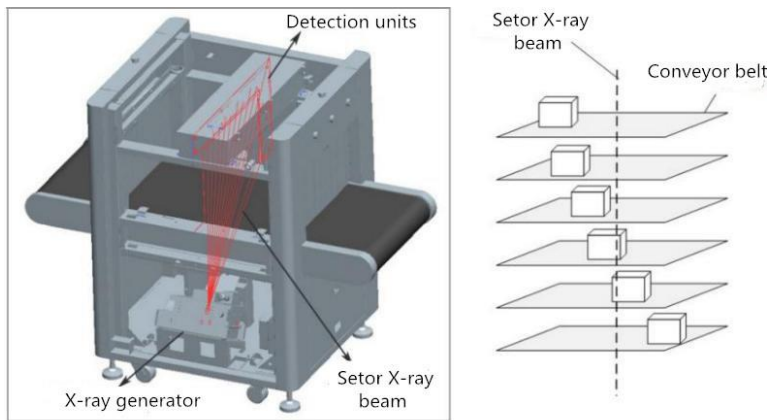

Figure2-2 Equipment Internal X-ray Diagram

2.2 Product Technical Indicators / Basic Parameters

General series security inspection system basic parameters									
The pattern of production (ZKX series)			5030A	5030C	6040	6550	8065	10080	100100
			Single energy	Dual energy	Dual energy	Dual energy	Dual energy	Dual energy	Dual energy
Basic parameters	Channel size	width (mm)	507	507	608	660	805	1004	1008
		height (mm)	305	305	405	510	660	806	1005
	The maximum Evenly distributed load (kg)		150	150	150	180	200	220	220
	Tube current(mA)		0.4~0.8	0.6~1.0					
	Anode voltage		80KV	140KV~160KV					
	Cooling method		Sealed oil cold/100%						
Use the environment and equipment routine data	Storage temperature / relative humidity		-40±2℃~+60±2℃/5%~95%(Not condensed)						
	Operating temperature / relative humidity		0℃±2℃~+40±2℃/5%~95%(Not condensed)						
	mains		AC220V(-15%~+10%), 50Hz±3Hz						
	Power loss (maximum)		≤0.5KW	≤0.5KW	≤0.5KW	≤0.8KW	≤1.0KW	≤1.5KW	≤1.5KW
	Noise level		≤55dB						
Image processing system	Image Processing		Pseudo color, gray color, high penetrate, low penetrate, super enhancement, mineral strip, organic strip, dynamic scan, inverse image and etc.						
	Storage capacity		More than 100, 000 pictures						
	System functions		High density alert, drugs and explosives inspection, date / time display, baggage counting, user management, TIP, training and other function						

Dual view series security inspection system basic parameters						
The pattern of production (ZKX series)			6550D	8065D	10080D	100100D
			Dual energy	Dual energy	Dual energy	Dual energy
Basic parameters	Channel size	width (mm)	660	805	1004	1008
		height (mm)	510	660	806	1005
	The maximum Evenly distributed load (kg)		180	200	220	220
	Tube current(mA)		0.6~1.0			
	Anode voltage		140KV~160KV			
	Cooling method		Sealed oil cold/100%			
Use the environment and equipment routine data	Storage temperature / relative humidity		-40±2°C ~ +60±2°C / 5% ~ 95% (Not condensed)			
	Operating temperature / relative humidity		0±2°C ~ +40±2°C / 5% ~ 95% (Not condensed)			
	mains		AC220V(-15% ~ +10%), 50Hz±3Hz			
	Power loss (maximum)		≤ 1.0KW	≤ 1.3KW	≤ 1.6KW	≤ 1.6KW
	Noise level		≤55dB			
Image processing system	Image Processing		Gray color, high penetrate, low penetrate, super enhancement, mineral strip, organic strip, dynamic scan, inverse image and etc.			
	Storage capacity		More than 100, 000 pictures.			
	System functions		High density alert, drugs and explosives inspection, date / time display, baggage counting, user management, TIP, training and other functions.			

2.3 Product Features

Our company's X-Ray Inspection equipment have the following characteristics, to provide users with more secure / convenient / fast service.

- Environmental design: Protective film on the lead curtain surface prevent hand from touching lead and avoid lead pollution.
- More secure: Radiation emission control, to avoid false emissions.
- One key shutdown: Turn off the key switch, the device automatically shut down, simple and convenient.
- Fault self-diagnosis: The system automatically determine the failure and give the message, easy to maintain.
- Special keyboard: Image processing operation, boot or shutdown equipment, and so on.
- Dynamic screen switching: Pictures can be switched between dynamic and static.

2.4 The Main Purpose and Application

X-Ray Inspection equipment using the latest imaging technology, display higher resolution, the image clearer, penetrating penetration and greater resolution. It can quickly and effectively detect a variety of dangerous goods and high-density substances. It is suitable for small-class packages such as small bags, suitcases, bags and so on. It is used in government, embassy, airport, convention center, exhibition center, tourist attraction, post office, shopping mall and hotel.

Chapter 3 Equipment Operation and Description

3.1 Turn-on

Step 1: Plug the device power cable into the power outlet (make sure the power supply and grounding settings are normal).



Figure3-1 ZKX5030



Figure3-2 ZKX6550

Step 2: Insert the key into the key switch and turn it on.

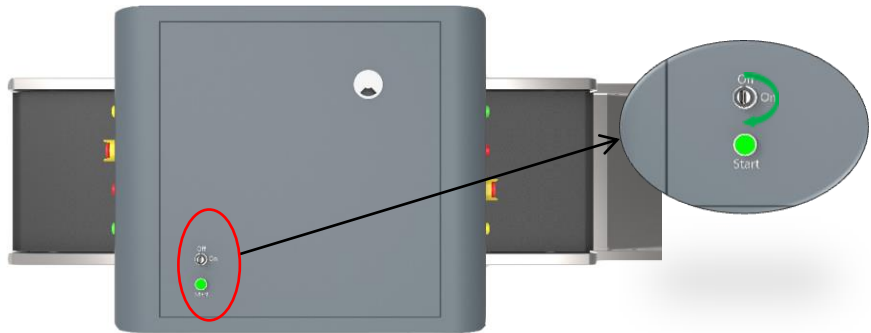

Figure3-3 Integrated



Figure3-4 Split

Step 3: Press the start button which was close to the key switch position to start the system. The green light will be lit.

Step 4: System will run preheating process automatically, preheating aim to protect the X-ray generator, and normally it will take 1-5mins. After preheating, device could start to do the scan work.

3.2 Item Inspection

Setting items: The subject needs to be placed on the conveyor belt or conveyor roller in a manner as indicated by the "INPUT BAGGAGE" at the entrance of the equipment.

Item inspection: When an item goes into tunnel, monitor will display the scanning image of item. Different colors indicate different materials. The direction keys on the console board or software interface could control the moving direction of conveyor belt.

Step 1: Put item at the tunnel entrance.

Step 2: Push "Forward" button.

Step 3: When item goes through tunnel, the X-ray indicator (red light) turn on.

Step 4: Remove item.

3.3 Shut Down

Step 1: Stop running conveyor belt, turn the key to "OFF" position, the indicator on the right side of keyhole will go out(Work indicator light (green) will go out one minute later).

Step 2: Disconnect the device from the external power supply. Take the key on the key switch and take care of it.

3.4 Indicator and Emergency Stop Button

Emergency stop button: If emergency happen, push any emergency stop button to stop X-ray emitting and conveyor belt.

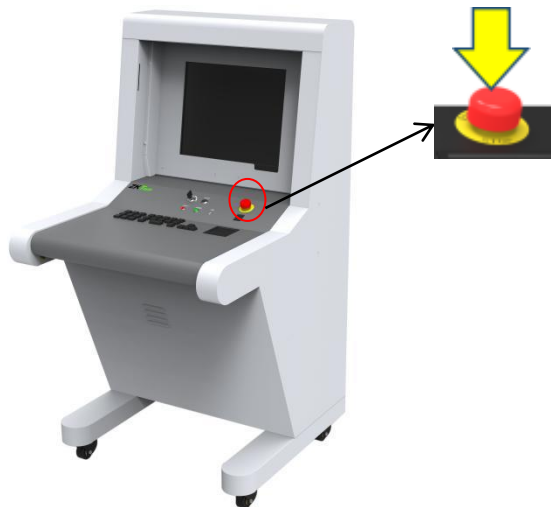

Figure3-5 Trigger

Notice: If you need to restore the normal state of the device (cancel the emergency stop state), turn the emergency stop button that has been pressed clockwise to eject it, and then press the

start button to resume.



Figure3-6 Restore

Notice: Restoration must press the start button.

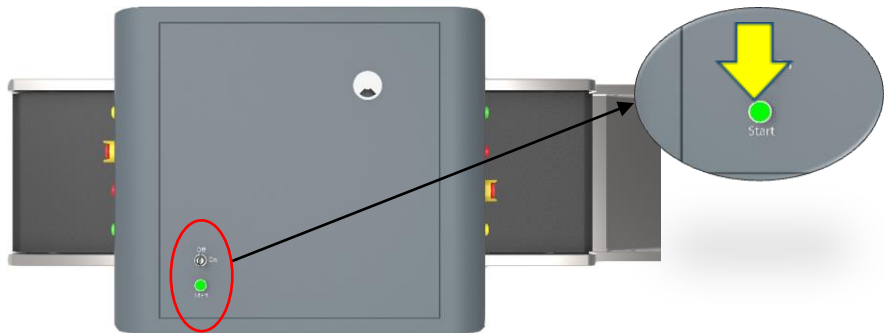

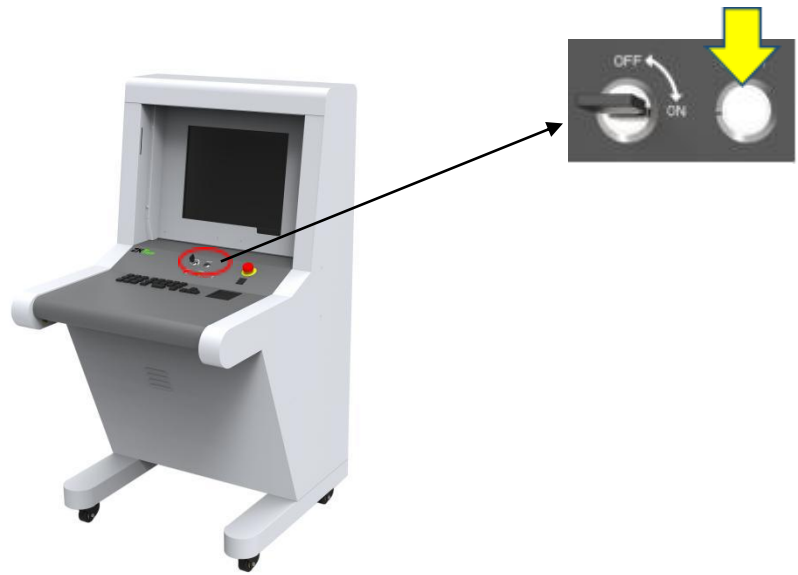
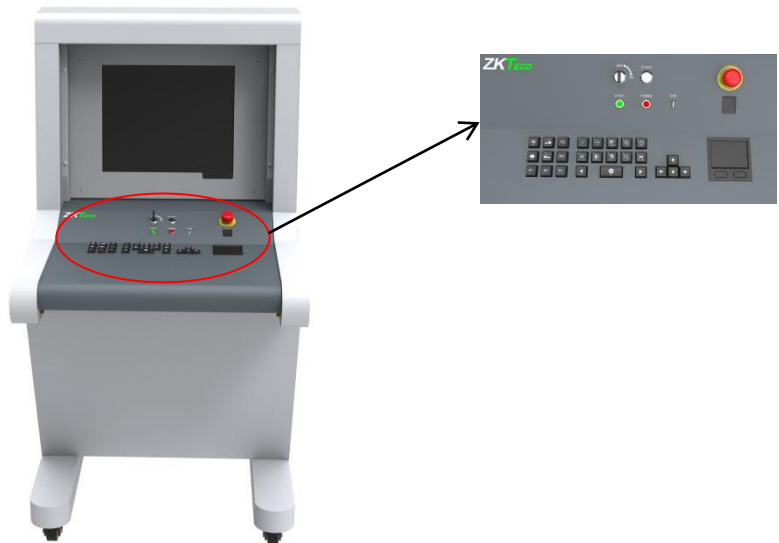

Figure3-7 Start button

Work indicator (green): When device turns on, the power indicator will lighten.

X-ray indicator (red): When device is emitting X-ray, the X-ray indicator will lighten.

3.5 Special Keyboard



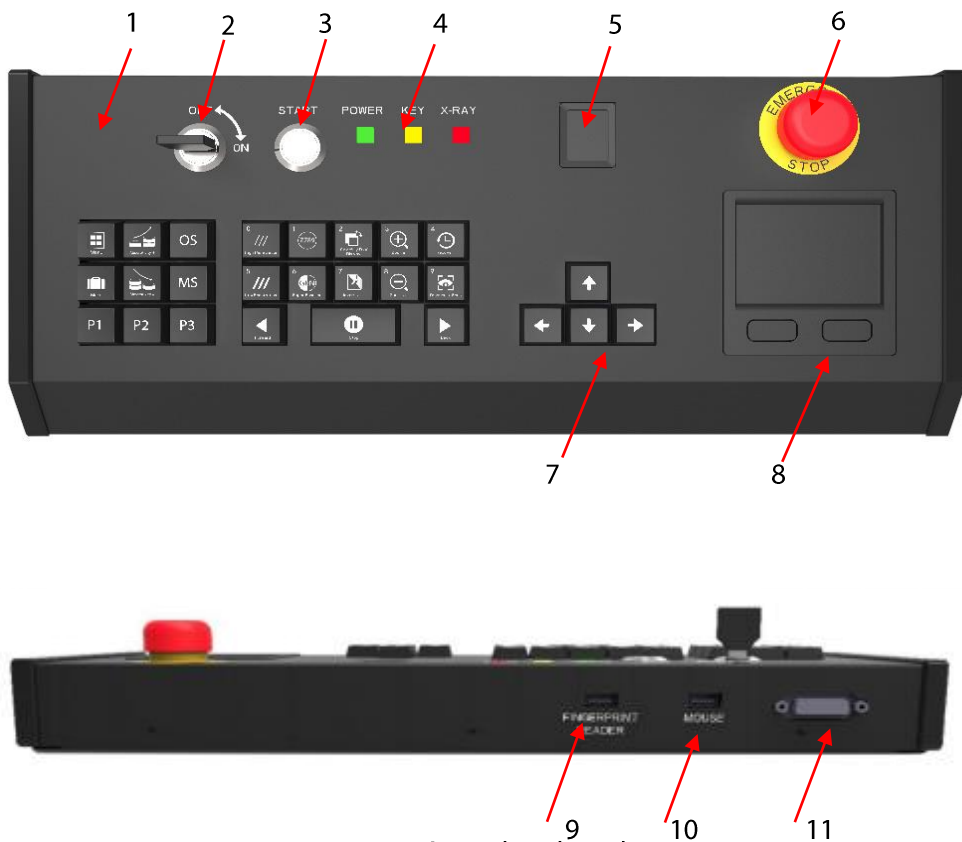

Figure 3-8 Special Keyboard

1- Keyboard outer covering	7 - Key zone
2 - Key switch	8 - Touch pad mouse
3 - Start button	9 - Fingerprint reader USB interface
4 - Indicator light	10 - Touch pad mouse USB interface
5 - Fingerprint reader	11 -DB15 Control interface
6 - Emergency stop button	

Description of electrical parts and key zone



Key switch: The main switch is designed to control the equipment to connect to the external power. It is used to prevent non-operators from operating the equipment.



Start button: Press the start button to power the equipment and the power indicator light (the green light) will turn on in the meantime. It means the system has already started.



Fingerprint reader: The fingerprint reader is used in login or adding new users. If the fingerprint is verified, the fingerprint reader will flicker green light; if the fingerprint is not verified, the fingerprint reader will flicker red light.

The fingerprint reader contains storage device which can store fingerprint data of 65,535 users and each user can store up to 10 fingerprints. User names can only be set to a number which is no more than six figures, the user ID to login are within (1-65,535).

Indicator light:

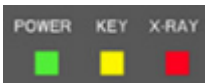

(i) X-RAY indicator light (red): When the security equipment starts X- ray, the red light will light up; when closing the X ray, the red light will go out.

(ii) Power indicator light (green): When the security equipment is powered on, the green light will light up; when the security equipment is powered off, it will go out.







Emergency stop button: In case of emergencies, press this button immediately. The ray device and conveyor of the equipment will stop working right away. Since the emergency stop button belongs to interlocking devices, the ray device and conveyor of the equipment will be powered on and put into normal use only after restoring all the interlocking devices and clicking the start button. Switch the button clockwise to make it pop out and press start button again will make the devices restore to normal status.

Key zone (control operation, image processing, menu/functional shortcuts)



(i) Keys to control conveyor: Click "Forward" or "Backward" will make the conveyor to operate in the direction set by the system . Click "Stop", the conveyor will stop running.

(ii) Window moving key / navigation key: When the image in the scanning area is

	<p>zoomed in or out, the bottom right corner will show a preview window automatically. Click any direction key to move the window. They can also be used as the navigation keys "up, down, enter, exit" in system menu.</p>
	<p>(iii) Functional shortcuts: Please refer to "4.12.2 Keyboard" for the method to set shortcuts.</p>
	<p>(iv) Menu: Click "Menu" to enter into the system menu.</p>
	<p>(v) Marking key: Please refer to "4.10TIP images".</p>
	<p>(vi) Image processing function: Please refer to "4.5 Image processing function" of the User Manual for the display effect. Those keys are all for image processing and the image will be displayed as per the setting.</p>

3.6 PC keyboard and mouse

Our company's security check equipment can not only operate with special keyboard, but also operate with PC keyboard. 5030A and 5030C are standard wireless button mouse sets to operate security equipment. You can choose the mouse to click the software interface choice function. Meanwhile, ordinary keyboard key has the image and function shortcut key function.

PC keyboard shortcuts

Function area (F1-F12)					
F1	P1	F2	P2	F3	P3
F4	Forward	F5	Stop	F6	Backward
F7	Image management	F8	Pull front	F9	Pull back
F10	F1-F12 disable or enable	F11	Zoom in	F12	Zoom out
Alphabet area					
A	Black & White	B	Inversing image	Image Processing Function	
C	Organic Material	D	Inorganic Material		
H	Absorptivity+	G	Absorptivity -		
I	High Penetrate	J	low Penetrate		
K	Perfect View	N	Dynamic Scan		
M	Menu	R	Recover		
P	Mark				
Direction keys					
↑	Up	↓	Down	After zoom in, move the frame	
←	Left	→	Right		
Numeric key					
The numeric key just a numeric function, 0-9				Accounts and passwords are no more than 8 digit combinations	

Chapter 4 Image Processing and Software Operation Guide

4.1 Main Interface

The blank area will display the scanning image by scrolling.



Figure 4-1 Main Interface

4.2 System Software



Figure 4-2 System Software Panel Introduction

① System main menu (Please refer to "4.6 System Options")

- ② Image processing function
- ③ Operating function area
- ④ Information area

4.3 Information Area

Account information: After the official login device account, the information area will automatically display the current login user name.

Parcel number counter: Display the current user, the total number of times to scan, can also display the total number of packages.

The date and time: Displays date and time of system.

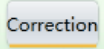
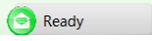

Image correction: When the device is working for a long time, slight changes in the work of the X-ray generator result in poor image quality. In this case, you need to click  to restore the image quality.

Work mode: Scan mode  , training mode  .

Device status: Normal state of the device will shows  Normal .

Ready	Device boot self-test, and self-test is correct, the system software shows " Ready ".
Scanning	Equipment normal operation, X-ray emission indicator light, the system software shows " Scanning ".
Error	When the device fails, the system can not connect with other components, the system software shows " Error ".

Emergency stop button: Emergency stop button is used in dangerous situations, once triggered will immediately disconnect the ray source and motor power supply, thereby protecting people directly hurt.

Ready	Normal state 
Emergency	When the emergency stop button is pressed 

4.4 Operating function area



Figure 4-3

Restore the image: Click "", after using system image processing function, the image can be recovery by a key, restore to the image color which has been set on system.

Conveyor control: Press "" on the screen or tap the corresponding conveyor control key on the Special Keyboard to accomplish the "Forward", "Stop", "Back" movements of the transmission belts, respectively.



Image pull front, pull back: During image interpretation, if the scanned image has crossed the display, the image pull front function can be activated to redisplay the image that has slid past the display. Click  icon or push the direction button on the control board to drag the image, it allows operator read former images.

Image zoom in and out: Click  and  or push the zoom button to zoom in and zoom out image. It could zoom in up to 64 times.

Combined Multi-processing Function keys: Through the "4.12.2 Keyboard " in the combination of key settings, the image processing functions and P1-P3 key button corresponding to facilitate image processing operations.



Figure 4-4

4.5 Image Processing Function

(The images used in the following are dual-view series security inspection system images, the horizontal image is also applicable to the general series security inspection system, the following figure is the original image used in image processing)



4.5.1 BW/CL(Black&White ↔ Color)



Figure 4-5 Black&White Image

All items will be displayed by 256 lightness levels.



Figure 4-6 Color Image

In order to make inspection work easier, different materials would display as different colors. Inorganic is blue, organic is orange, mixture is green.

4.5.2 HP (High Penetrate)

Improve the contrast of dark area.



Figure 4-7 High Penetrate Image

4.5.3 LP (Low Penetrate)

Improve the contrast of light area.



Figure 4-8 Low penetrate image

4.5.4 PV (Perfect View)

This function would show the both of easy-penetrate items and hard-penetrate items at the same time. Even if the item hide between two metal boards, it still could be showed clearly.



Figure 4-9 Perfect View Image

4.5.5 OM(Organic Material)

Organic material would show as B&W.



Figure 4-10 Organic Material Image

4.5.6 IM(Inorganic Material)

Inorganic material would show as B&W.



Figure 4-11 Inorganic Material Image

4.5.7 IN(Inversing)

Invert colors function is applicable to observe the condensed cable.



Figure 4-12 Inversing Image

4.5.8 Brightening/Decrease (Changes of Absorptivity)

Adjust the lightness of the scanning image.



Figure 4-13 Brightest Image



Figure 4-14 Decrease Image

4.5.9 DS(Dynamic Scan)

Image would display dynamically with this function.

4.5.10 PS(Pseudo-color Display)

Single-energy device standard set to pseudo-color display.

Dual energy device standard set to color display.

All the inspected objects are displayed in different color levels of spectrogram and the color represents the actual X-ray absorption degree of the object.

4.5.11 Suspicious Organics Enhancing of Z789

The atomic number of explosives and drugs are concentrated within the range [7,9], suspicious organics enhancing function is to highlight the substances with suspicious organics to be bright red and the other substances will display grey. It's helpful to view suspicious explosives and drugs. Z789 can be used by pressing the "E" key on the special-purpose keyboard or wireless keyboard.

4.6 System Options

System has two user groups, which are administrator and operator. Administrator and operator have different authorities, operator only could change image setting and modify password of current user and administrator could modify all settings except "Device Maintenance".



Figure 4-15 Administrator and Operator Menu

4.7 Image

Image includes image preview and image setting.

4.7.1 Image Preview

Single click image list on left side, a thumbnail image would show on right side.

All images which generated after scanning (originally scanned image) will be automatically saved in the hard drive of the scanning equipment. The preview interface will display the first 16 parcel images which have been scanned currently. And the storage order of image files will rank by chronological order of checking image.

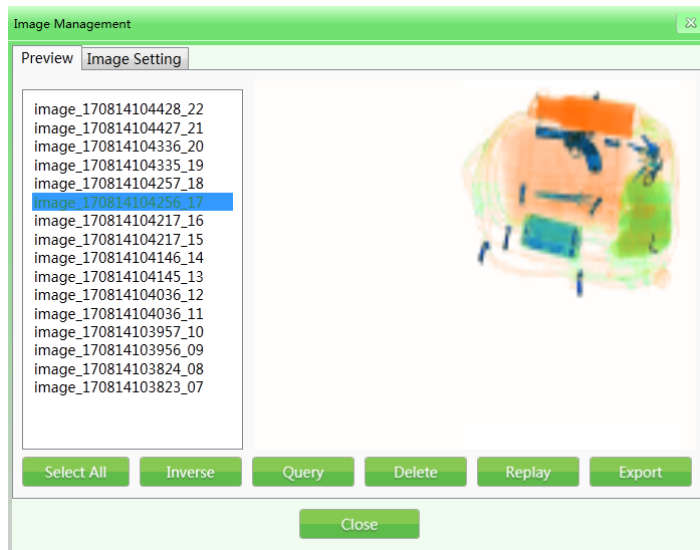

Figure 4-16 Image Preview

(Example: The naming rules of parcel image: image + parcel scanning time + serial No, for example, image_170814104217_16)

- 1) **Image enquiry:** During image inspection process, you can check former images through image enquiry.

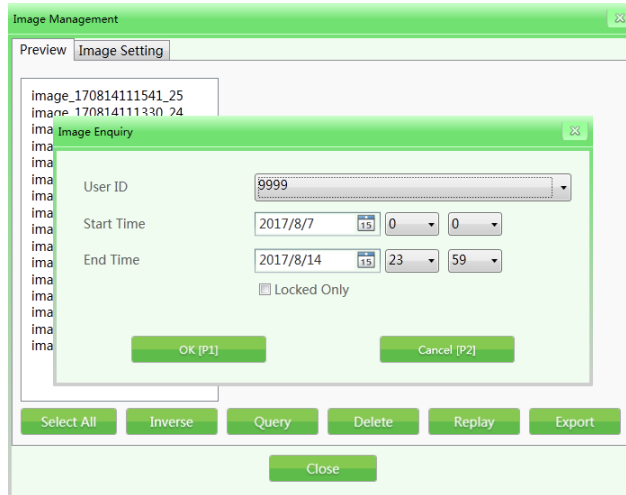

Figure 4-17 Image Enquiry

- 2) **Delete:** The authorized group can delete the scanned parcel images of its own or subordinate.
- 3) **Replay:** Select replay function and the selected images will be displayed on the main interface.
- 4) **Export:** If you need to export the image files to save in other devices, then click "Export", insert storage devices (such as USB flash disk) and select the images and files to be exported (the format can be ZKX, BMP and JPG). As shown below.

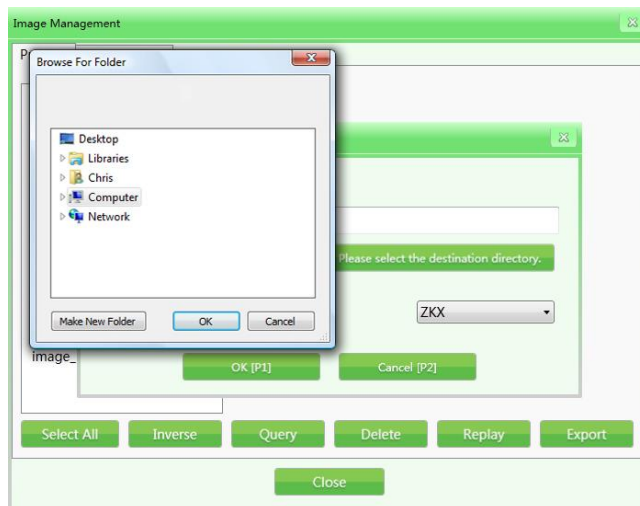

Figure 4-18 Image Export

Notes: If the images are exported in the format of BMP or JPG, then they are standard WINDOW

image and can be viewed or previewed by any image software;

If the images exported are in the format of ZKX, then they can only be displayed or previewed by ZKXScanner software.

4.7.2 Image Setting

The image setting selected currently will be reflected in display interface center in real time. Basic setting has been completed for users before delivery and it's not suggested to modify the setting.

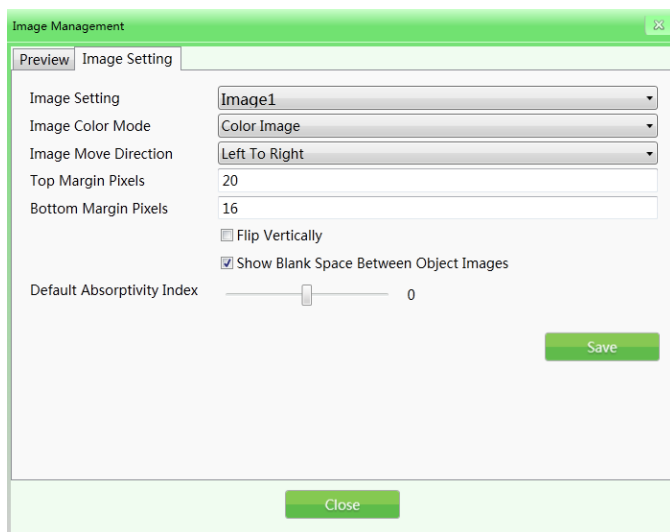

Figure 4-19 Image Setting

- 1) **Image setting:** The image setting includes image 1 and image 2 (for double-screen display). You can set image separately which displayed on different screens. If the equipment is single-screen display, you can only select image 1.
- 2) **Image color mode:** Image color refers to the display color mode designated during scanning.

Including:

(i) Black & White image	(v) Organic material
(ii) Color image	(vi) Suspicious organics enhancing Z7
(iii) Pseudo-color 1	(vii) Suspicious organics enhancing Z8
(iv) Inorganic material	(viii) Suspicious organics enhancing Z9

For their image effects, refer to "4.5 Image processing function".

- 3) **Image move direction:** The scanned parcel image can be displayed from left to right or from right to left.
- 4) **Top/Bottom margin pixels:** The setting range for Top or Bottom margin pixels in the screen scanning area will differ for equipment of different models and configure action. The bigger the setting value, the larger the margin pixels area (the white edge).
- 5) **Flip vertically:** Flip vertically of parcel images scanned in main interface.
- 6) **Show blank space between object images:** Add blank areas between the scanned parcel images so that operators can clearly identify the parcel images scanned before and after.
- 7) **Default absorptivity index:** Absorptivity can be used to show the details of objects in different materials and thickness in the image. Variable absorptivity still keeps certain contrast beyond absorptivity range. This function can brighten/blacken the whole image (equal to the fine tuning of high/low penetration). The lower the absorptivity level, the brighter the image will be, so the decrease effect will be in the opposite way. Levels of the system setting are 50, i.e., -25~+25. Brightening corresponds to the "absorptivity-" and decrease corresponds to the "absorptivity+" on the keyboard.

4.8 User Management

By using this function, the administrator can add and manage operators, reset operator password and etc by himself. Our software which is open to users supports two-level authority by default, in which the authority of administrator is greater than that of operators and operators can only change information in their own accounts.

Notice:

The user name shall not exceed 6 digits, such as 1-999999.

The password shall not exceed 8 digits, such as 1-99999999.

The default password for a new account is 123456.

4.8.1 Account Setting

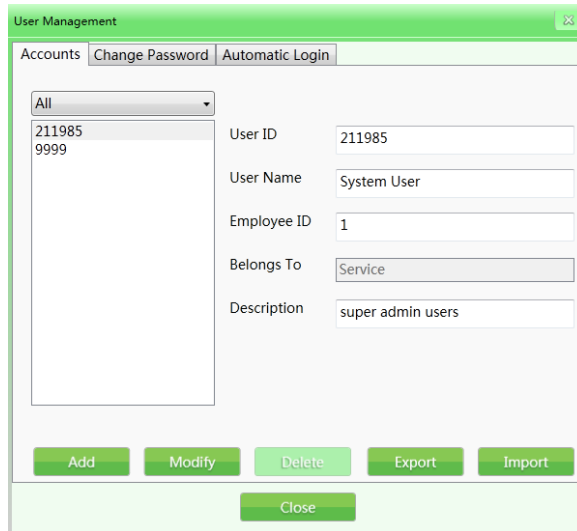

Figure 4-20 Accounts

Add: Click "add" to add a new operator account. User ID and password can only use no more than 8 digits. The fingerprint reader contains storage device which can store fingerprint data of 65535 users and each user can store up to 10 fingerprints, the user names to log in by fingerprint are within the range of 1-65535.

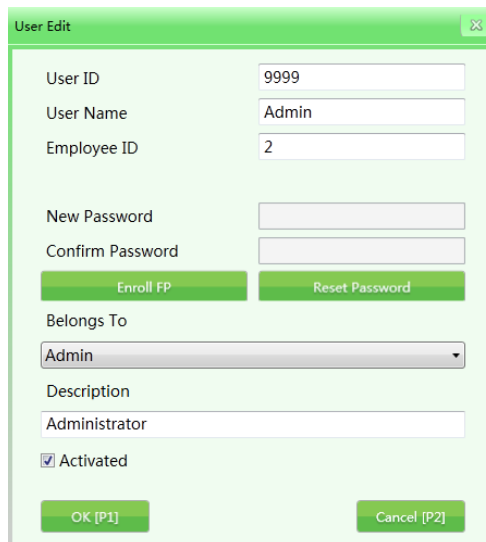

Figure 4-21 User editing interface

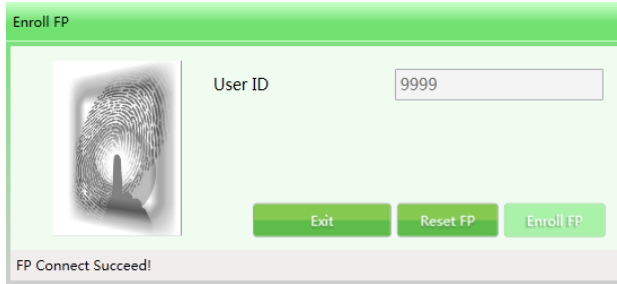

Figure 4-22 Fingerprint registration

- 1) **Modify:** To click "Modify" can also enter into User edit interface to edit personal data.
- 2) **Delete:** Click "Delete" to delete the user (operator) who will not use this equipment any more.
- 3) **Import/Export:** This function allows administrator to import/export the account group information (only for ZKX Series, document type is XML).

Notice: Once the user is deleted, it cannot be recovered. Please be careful during deleting users.

4.8.2 Change Password

If need to modify the password, please enter elder password then type a new one.

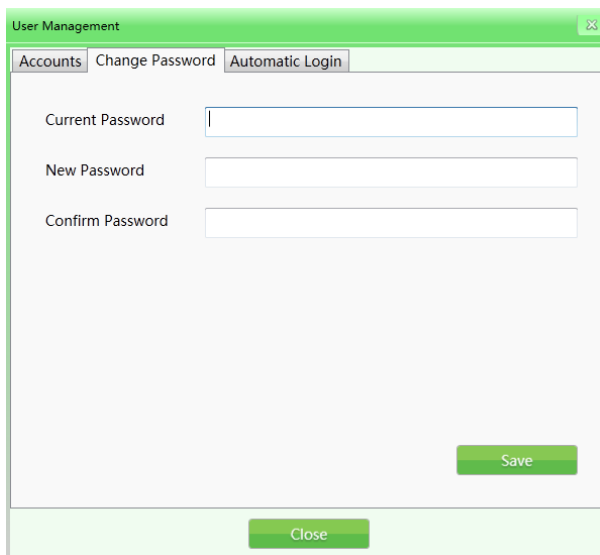

Figure 4-23 Change Password

4.8.3 Automatic Login

Set default automatic login account.

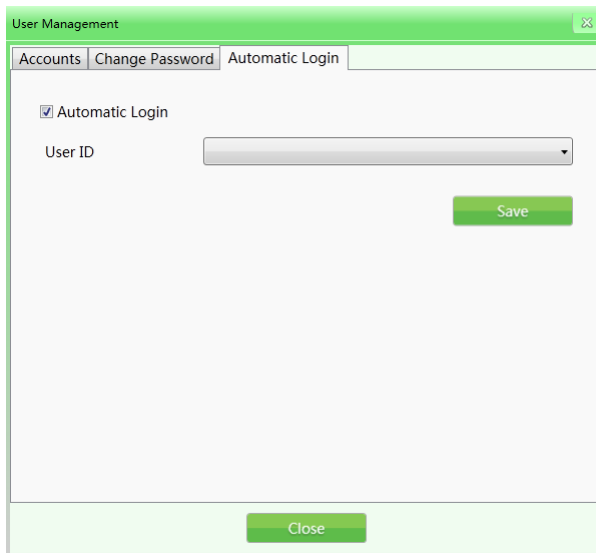

Figure 4-24 Automatic Login

4.9 Log Management

This function is open to administrator, so that administrator can get statistical data and view of the working condition of operators on this machine. Log management includes: Three log types, i.e., "Startup log", "Session log" and "X-ray radiation log". The user can enquire qualified using record by corresponding conditions.

4.9.1 Startup Log

Recording running time of device: It could search by Week (in the year) , Month(in the year),and Season(in the year) .Statistic time indicates the start time in each period.

Export record: User could click single or several records to choose records that need to export. The data will export as CSV file. Example: 2017-08-14, the statistical period is day (In the Month), click the export and get results. See the figure below.

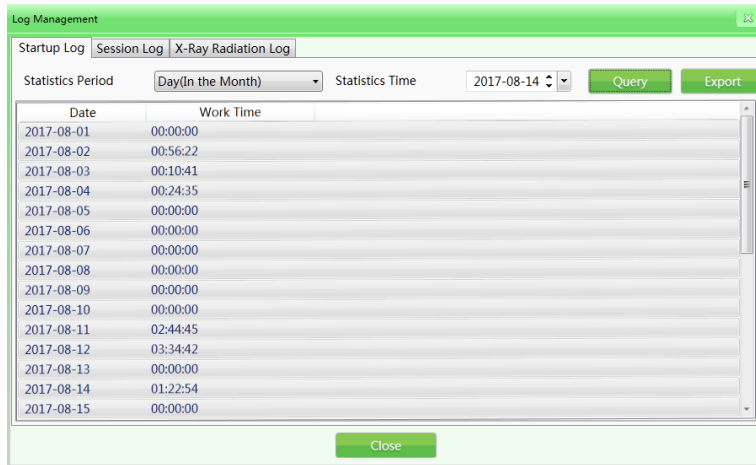

Figure 4-25 Startup Login

4.9.2 Session Log

Take operator as unit, record the working time of each operator. System will record the start time and end time of each operator's working period.

User ID: Choose specific user or select all users.

Statistics period: It is same as running log. Working log also could search by Day, Week, Month and Year. (Example: 2017-08-14, select all for the user name and hour in the day for statistical period, and click the query to get results. See the figure below)

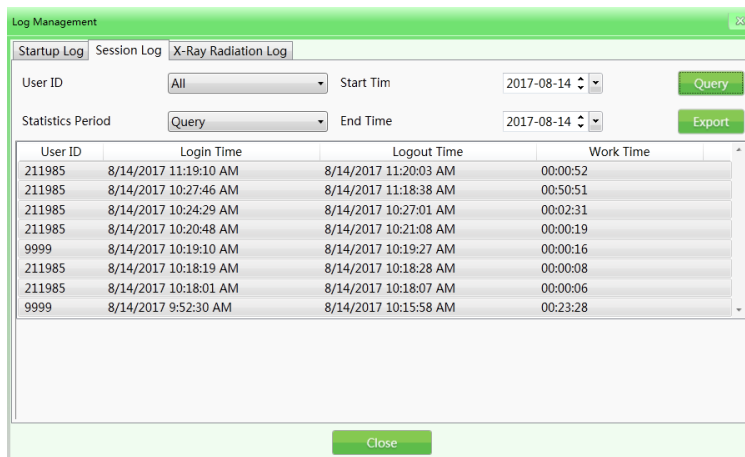

Figure 4-26 Session Login

4.9.3 X-ray Radiation Log

Targeted mainly at X-ray generator, record the using time of X-ray generator within query data

range so that the administrator can get hold of the running condition of the equipment. Select the needed records from query result and the records can be exported. The export operation can refer to the above export operations.

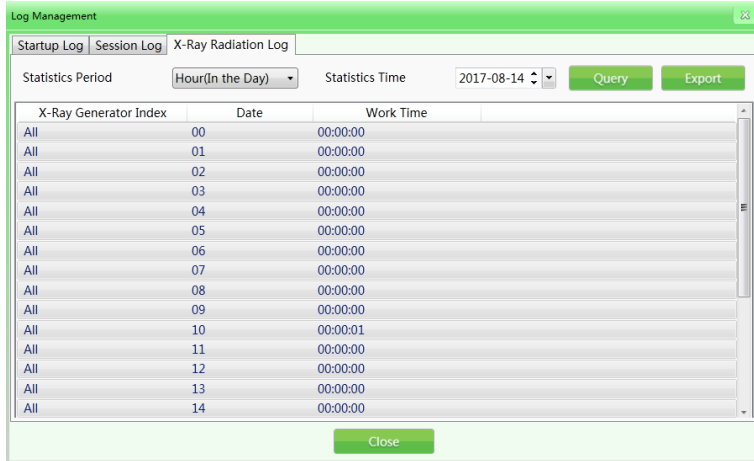

Figure 4-27 X-ray Radiation Login

4.10 TIP(Threat Image Projection)

Based on relevant parameters set by the administrator, the system can automatically inset the luggage image containing dangerous articles into the images of scanned articles or inset the dangerous articles of different kinds into the actual images of inspected articles. Like normal images, TIP images will be saved automatically by the system. From the statistical report of the system, the administrator can know the correct identification and omission times of each operator on the inserted dangerous articles. And thus get to know the image reading level and efficiency of each operator. (After checking "√" to initiate this function, it can operate under image scanning mode and training mode)

TIP purposes:

- 1) To enhance vigilance of operators to prevent the operators from being in unexcited state due to absence of dangerous articles for long time.
- 2) Image reading ability of security inspectors is one of the skill assessment means.

TIP operation procedure:

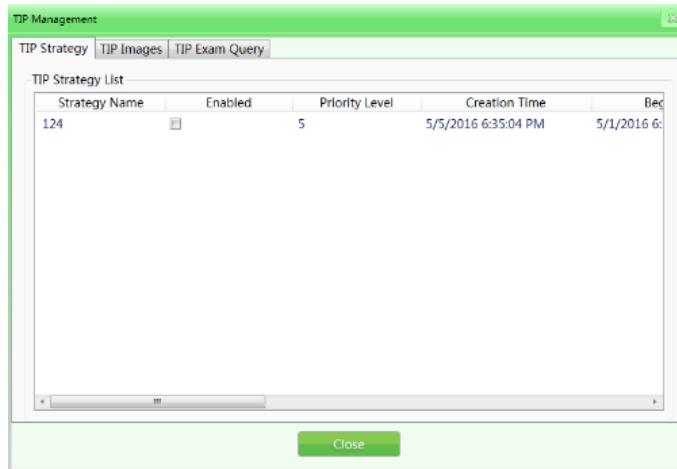

Figure 4-28 TIP Operation

Log in the administrator account, set TIP strategies and set the system in default TIP assessment state successfully. When the operator operates equipment and finds dangerous articles, the operator must press the "Stop" button of the conveyor first and press the "Mark" button on special-purpose keyboard or the "P" button on common keyboard, then the system will show successful marking and the operation record will show successful identification by the operator. If the operator fails to inspect the inserted dangerous articles, it will show "You have ignored a TIP image" immediately after passing of dangerous articles and this mistake will be recorded. TIP system interface is as shown in the following figure:

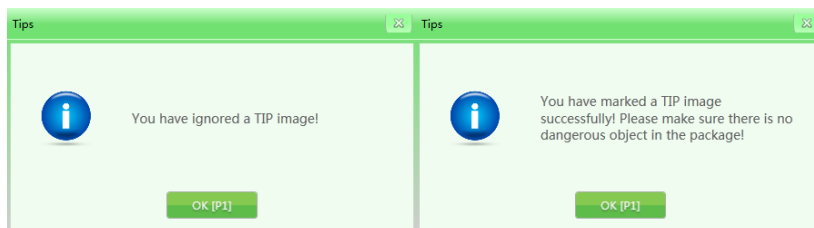

Figure 4-29 TIP Notice

4.10.1 TIP Strategy

It can set TIP basic information and projection percent.

Basic information set in TIP: Strategy name, priority level (1-10), begin time, end time, user role category, projection percent, dynamic judgement time and static judgement time. As shown in the following figure:

Basic Information

Strategy Name: 124 Enable

Priority Level(1-10): 5

Begin Time: 2016-05-01 18:34:54

End Time: 2017-12-31 18:34:54

User Role Category: Admin

Projection Percent(%): 100

Dynamic Judgement Time(3-6s): 4

Static Judgement Time(3-20s): 6

TIP Type Projection Weight Setting

TIP Type	Projection Weight(0-10)
Knife	10
Gun	0
Explosive	0
Cash	0
Fruit	0

OK [P1] Cancel [P2]

Figure 4-30 TIP Strategy

Strategy name :Set the strategy name according to training records and query needs;

Enable: Means the TIP initiate mode which can be set as on or off, when checking "√", it means the TIP is on; when not checking "√", it means the TIP is off. In addition, the following settings can only be initiated when the TIP is in "ON" state;

Priority level: The administrator will set the priority levels (1-10 levels and 1st level is the lowest level) for newly built assessment items. Items with higher levels will be used in priority in assessment, if the priority enable conditions are not satisfied, the system will initiate inferior items;

User role category: Select operators or administrators to receive TIP training based on different User role categories;

Projection percent: Means the percentage to insert dangerous articles in the training image collection;

Dynamic judgement time: When the article images are moving, if there are TIP dangerous articles inserted, then the time period from appearance to disappearance of TIP dangerous articles is defined as dynamic judgement time (determine whether the articles are dangerous within the time limit);

Static judgement time: When the article images are still (not moving), if there are TIP

dangerous articles inserted, then the time period from appearance to disappearance of TIP dangerous articles is defined as static judgement time;

Projection weight: It mainly allocates the weight on different TIP types during use. TIP types mainly include: "Knife", "gun", "explosives", "cash", "fruit" and etc.

4.10.2 TIP Images

TIP image refers to image gallery which will list images of dangerous articles to be inserted and automatically generate list. Open the image in corresponding list to preview the image.

Export: Within authority limits, export TIP images in the list as typical images to the selected files (smart export in the format of ZKX);

Import: Within authority limits, import typical images as TIP images (only in the format of ZKX);

Delete: Within authority limits, select corresponding sample images and click "Delete" to delete corresponding TIP images.

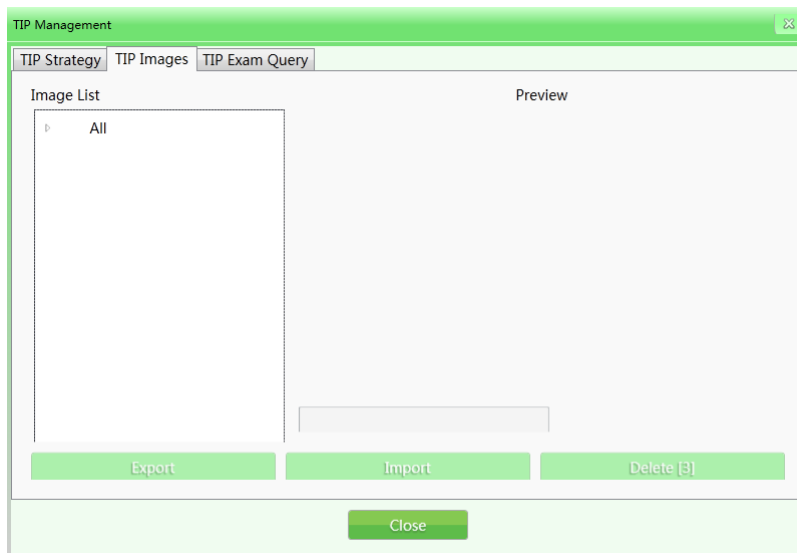

Figure 4-31 TIP Images

4.10.3 TIP Exam Query

Query about TIP inserting process, list information such as "User name", "Date", "Quantity of luggage scanned", "Missing times", "Marking times" and "TIP inserting times" and export those information by pressing "Export" button. The TIP report generated in this login will be shown in the next login.

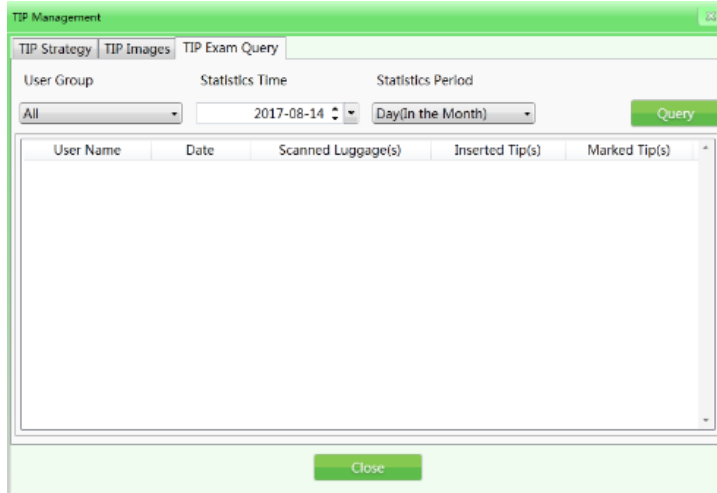

Figure 4-32 TIP Exam Query

4.11 Training

After initiating training function, the administrator can train the operators on image reading. The training function is used to train and assess operators' ability to identify dangerous and prohibited articles. The training doesn't need to start up conveying belt and X-ray generator, but to simulate the article scanning process and display a series of scanning images saved by the administrator in Industrial Personal Computer (IPC) disk on the screen. The "Training" interface has "Parameter Setting" on the left and "Operation Panel" on the right.

4.11.1 Parameters Setting

Click "Training" on the main menu and enter into the training interface, which is as shown in the following figure.

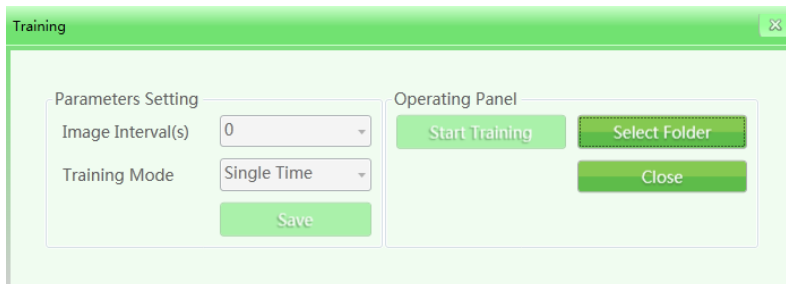

Figure 4-33 Training Set

Image intervals: Set the displaying time interval between neighboring images. Select "Image interval" by control cursor and set the time interval, such as "1", "2" or other time intervals

deemed appropriate by the administrator. The setting range is between 1-120 seconds.

Training mode: After selecting this function, control the cursor to click the pull-down list which will show "Single time", "Sequential circulation", "Random circulation" and other modes. The operator can select "Training mode" based on specific need.

4.11.2 Operation Panel

The "Select folder" button can be used to manually select an image gallery used in training on storage devices.

Notes: If the customer initiates TIP function, then all the operation results in training demonstration will be recorded in the system. The system will get statistical data on TIP quantity and TIP data of all users. The administrator can check relevant data in TIP exam query.

4.11.3 Training Procedure

Step 1: Select folder to choose scanning parcel files required in training.

Step 2: Set parameters (the save button is to save settings and backups).

Step 3: Click to start training. The training box can be deleted but it will still be shown in menu bar (the icon means the training is going on).

Step 4: Click any operational key of the conveyor (in training mode, clicking any operational key of the conveyor will not cause actual running of the conveyor) or image front-pulling key, the interface center will show the training images when simulating operation of machine based on parameter setting.

Step 5: When finding suspicious articles, press "Stop" button of the conveyor and the "Mark" button on special-purpose keyboard to mark the image.

Step 6: If you want to finish the training, click the pause button of the conveyor to stop the moving image and then click the menu or right click the mouse to select "finish" to finish the training.

4.12 System Settings

This function is open to the administrator, including: intelligent identification, keyboard setting, counter setting and others.

4.12.1 Intelligent Identification

Set "High density alert" and "Drugs and explosives inspection" in the "intelligent identification" interface; the initiate mode and sensitivity can be set separately (when checking "√" to switch

to initiate mode respectively, the alert box of "High density alert" is red, the alert box of "Drugs and explosives inspection" is pink and the sensitivity can be further set as 1-5), and 5 is the highest sensitivity; when setting "flicker the alert box", the box will flicker continuously to give out alarm.

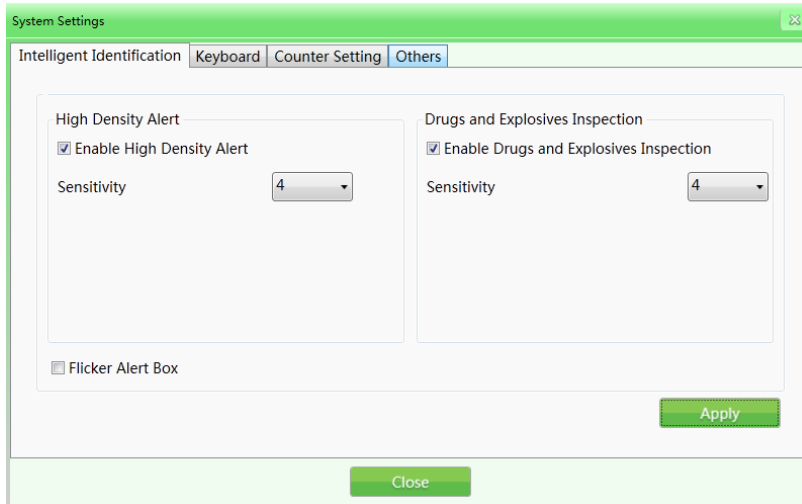

Figure 4-34 Intelligent Identification

4.1.2.2 Keyboard

Functional key (shortcuts): When needing to set combined processing keys, click "Keyboard" button and the system will pop out the following interface. Then select corresponding combined image processing function in the combined processing pull-down list based on specific needs.

Shortcut keys options

Color + perfect view	Black & White + super enhancing
Color + inversing	Black & White + inversing
Color + high penetration	Black & White + high penetration
Color + low penetration	Black & White + low penetration
Switch between Black & White and color	Restore

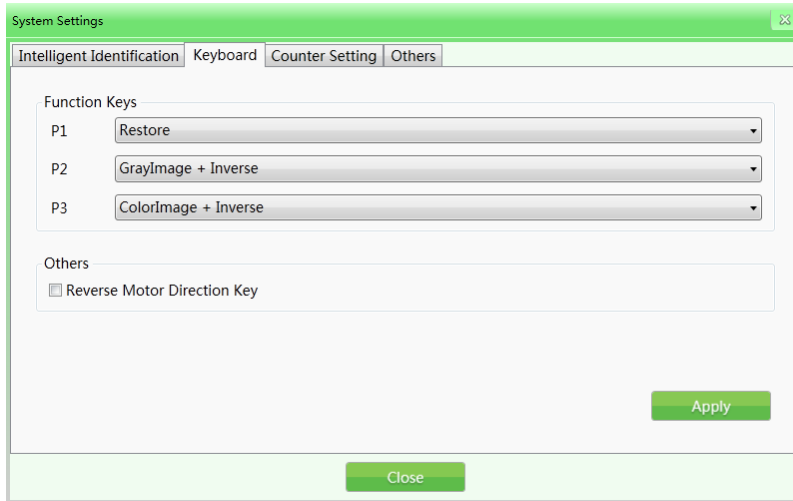

Figure 4-35 Keyboard

Reverse Motor Direction key: The default setting of the equipment is designed for the conveyor to run in forward direction (the marking position is entrance direction, running from the "entrance" to "exit" is the "forward direction"). The running direction of the conveyor can be reversed if the user needs to.

4.12.3 Counter Setting

If the operators need to know and record the quantity of the inspected luggage, they can check the "Counting of inspected articles" on system status panel or in the "Counter setting" interface.

Total package counter: Means the total number of the inspected articles since the equipment has been put into use. "Total package counter" can not execute "Reset" operation.

Temporary package counter: Means the number of the inspected articles after this user logs in the system this time.

Notes: The selection will immediately apply in the parcel counting in the main interface

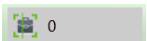

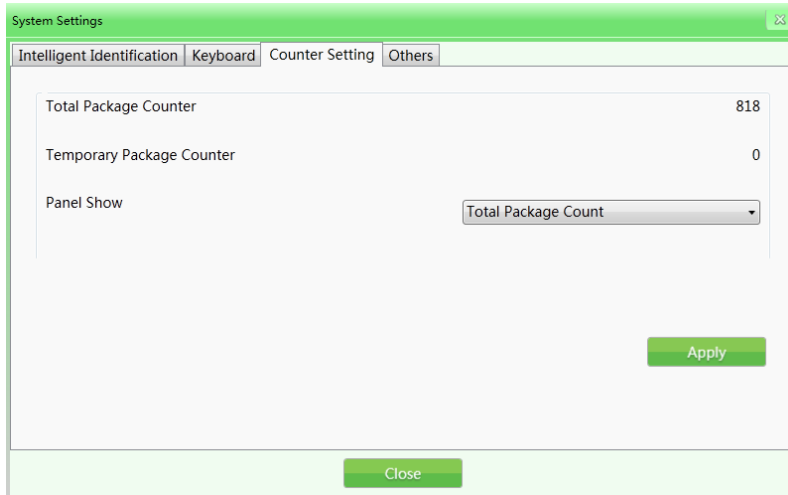

Figure 4-36 Counter Setting

4.12.4 Others

Date: When needing to set the time and date, click "Date" button to set local time on the equipment.

Time zone: You can also choose it for change current time.

Summer time: If you have a daylight saving time, you can choose directly. If not, the default display is not selectable.

Energy Saving Mode: Our company's security device with energy saving mode can be used to turn on this function. When the entry is sensed, the device will be turned on and the machine will automatically turn on the motor to complete the scanning process automatically. At the end, the motor will automatically stop running.

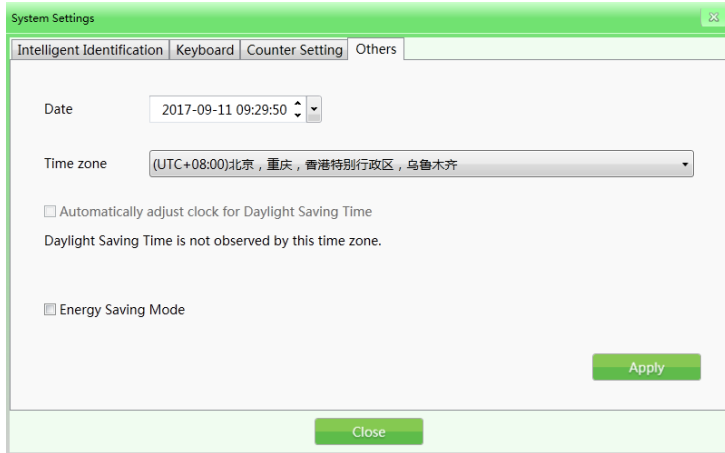

Figure 4-37 Other

4.13 System information

It included running time statistics information and configuration.

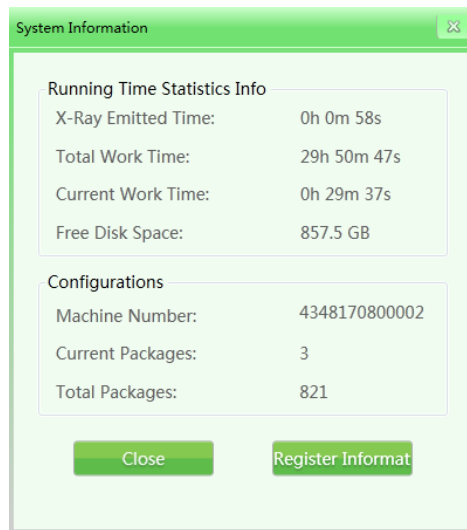

Figure 4-38 System information

4.14 Log out and shutdown

Log out: It is for changing the current user.

Shutdown: It just shutdown Industrial motherboards, after that, turn the key to “off”.

Notes: You must turn the key to “off”, wait for the work light(green light) goes out,until that the system will finally shut down.

Chapter 5 Daily Maintenance

The X-ray security inspection system is a sophisticated mechanical and electrical product. So the user is required to adhere to the principle of prevention first. The user should not only get to know the technical performance, software system management and operation procedure of the equipment, but also to be good at daily maintenance, which is one of the important factors to reasonably use and operate this equipment. This chapter illustrates and introduces by centering on daily maintenance.

5.1 Matters Needing Attention on Maintenance

- 1) The equipment should be installed in ventilated, dustless and dry environment and avoid high temperature, moisture and direct sunlight.
- 2) Clean the dust on the equipment by brush and vacuum before maintenance.
- 3) If the components or connectors are loose, tighten them immediately.
- 4) Do not let foreign matters or liquid into the equipment during maintenance in order to avoid electric leakage or accidents.
- 5) If the components get rusty or damaged, please contact our staff without delay and do not dismantle the equipment.

5.2 Daily Cleaning

Note: Do not power the equipment during cleaning.

5.2.1 Outer Surface of the Equipment

After operating for long time, the outer surface of the equipment, control console, display screen and other parts will be covered with all kinds of dust, stain and other dirt. To guarantee normal function of the equipment, the outer surface of the equipment must be cleaned regularly.

Wipe the outer surface of the equipment with wet towel:

- 1) The surface of side board and top board of the equipment;
- 2) The guard boards on both sides of the conveyor and the cover board under the conveyor, etc.

- 3) The surface and edges of belt;
- 4) Ventilation port;
- 5) The surface and other places of the control console.

5.2.2 The Interior of the Equipment

The interior of the equipment is utmost important since it includes Industrial Personal Computer (IPC), electrical control panel, air switch, detection box and other important parts. When cleaning the interior on a daily basis, it's suggested to remove the stubborn dust by brush or vacuum.

- 1) IPC part;
- 2) Electrical control panel part (please take off the installation trunking and trunking cover) and electrical device terminal;
- 3) Air switch part;
- 4) For X-ray generator and detection box, clean the dust on the surface ,do not unscrew the retaining screw;
- 5) Cover of cooling fan and dust-proof fan.

5.2.3 Display, the Hole Site of Photoelectric Sensor and Control Console

- 1) During daily running of the equipment, the surface of the display and fingerprint will be covered by dust which will influence the operators when reading images and identifying articles. The display screen (in off state) can be cleaned by wet towel with detergent.
- 2) When the hole site of photoelectric sensor is blocked or jammed, the radiation source will always be in radiation state. If the radiation light is always bright but there's no image on the screen, then the hole site of photoelectric sensor may be jammed by dust or dirt. In this circumstance, you can use brush to clean the hole and then vacuum the dust.
- 3) Open the rear of the control console by triangle keys and clean the stubborn dust inside by brush or vacuum.

5.3 Regular Check

If problems occur to the following devices or installations, please contact professional maintenance personnel for consultation and repair.

5.3.1 Photoelectric Sensor

Start up the equipment and place a parcel on the conveyor for inspection. If images of the articles can be normally displayed on the screen, then the photoelectric sensor functions well.

If images of the articles cannot be normally displayed on the screen or the images are always moving and gliding across the screen, then please clean the hole site and surface of the photoelectric sensor. Conduct inspection again.

If the images still cannot be displayed, please contact professional maintenance personnel for consultation and repair.

5.3.2 Inspect the Conveyor

After working for a long time, the conveying belt will be unevenly loaded since the weight and position of articles are not uniform, which may cause the conveying belt to deviate from the center position of the passage. In this case, please contact professional maintenance personnel for consultation and repair.

5.3.3 Inspect the Lead Curtain at the Entrance and Exit of the Passage

If the interval spaces of lead curtain are too big or the lead curtain falls off and gets damaged, please contact professional maintenance personnel for consultation and repair.

5.3.4 Inspect X-ray Indicator Light and Power Indicator Light

During operation of the equipment, if the X-ray indicator light (red) or power indicator light cannot light up normally, please contact professional maintenance personnel for consultation and repair.

5.3.5 Inspect the Emergency Stop Button

The emergency stop buttons at the entrance and exit of the equipment and on the special-purpose keyboard are the critical safety devices. When the equipment is inspecting articles normally, if pressing the emergency stop button, the conveyor stops running immediately and X-ray indicator light goes out, it indicates the emergency stop button functions well. Later, restore the emergency stop button and press the start button, the screen displays "normal", then the emergency stop button returns to normal. If abnormalities occur to the emergency stop button, please contact professional maintenance personnel for consultation and repair.

5.4 Storage Conditions and Notice

- 1) If the equipment needs to be dismantled before delivery, repeat the inverse installation

process.

- 2) The system should be stored in clean and dry places, high-temperature or moist environment may cause damage of the system parts. If the equipment is out of use for a long time, it should be stored in original packaging box.
- 3) Equipment which needs to be stored for a long time should be packaged and well stored in clean, dry and well-ventilated warehouse where there should be no corrosive gas around and the relative humidity should not be more than 80%.
- 4) According to the regulations of Measures for Management of Security Permission of Radioisotope and Ray Devices issued by the People's Republic of China, the X-ray radiation device in this product is Type III ray device. The customers are suggested to report to local competent environmental department.
- 5) When the equipment needs to be scrapped, please consult relevant professionals or local competent environmental department for handling methods.

5.5 Common Failures and Trouble-shooting

This section introduces the failures that may occur, causes and trouble-shooting methods. If there are problems that cannot be solved, please contact our professional maintenance personnel for consultation and repair.

Maintenance of the X-ray security inspection equipment can only use the components and spare parts manufactured by our company and provided for specific conditions . In case of machine failure due to unauthorized maintenance or machine damages caused by using spare parts not provided by our company, our company will not take any responsibility.

Failure 1: The equipment won't boot normally by pressing the start button

- 1) If the equipment won't boot normally, check the power inlet plug on the equipment to see whether it's plugged in, check the power supply voltage first to see if it's normal (under normal circumstances, the voltage of AC power supply should be 200V-240V); if there is no voltage or the voltage is abnormal (not within 200V-240V), then examine the power supply voltage or report it to relevant department to handle until the power supply voltage return back to normal.
- 2) If the power supply voltage is normal, but the equipment still won't boot, then check the connection terminal 1 and 3 to see if the voltage between the two terminals is 200V-240V.
- 3) If it's not normal, check the air switch on the equipment to see whether it disconnects or

not. Check the fuse to see whether it disconnects. If it does, please replace it.

- 4) If connection in the control line socket (DB15) on the special-purpose keyboard loosens, please re-plug the control line and check the equipment to see whether it can boot normally.

Failure 2: The conveyor belt won't run

- 1) If it happens, check whether one of the "emergency stop buttons" is pressed(emergency stop button on the device and console respectively) ; if so, rotate the button clockwise and release the button and then press the "Start button" to get the conveyor belt running.
- 2) If the conveyor belt still won't run and display the words "emergency stop is triggered", then check two "micro-switches" on the equipment. Normally, when the two "side boards" on the equipment are tightened, the "micro-switches" will be triggered. If the "micro-switch" is not triggered due to loose of any one of the "side boards", it will also lead to "emergency stop is triggered". Tighten the side board and then press the "Start button" to get the conveyor belt running.
- 3) If the screen displays "emergency stop is normal", check the "over-current protector" DZ108-20 of the conveyor whether it trips (means over-current of the motor cylinder, for which the trip is usually caused by over-weight of parcels). If it does, restore it manually (press the white button on the DZ108-20) and the conveyor should be running normally (For AC motor cylinder).

Failure 3: The screen displays "System self-inspection error"

- 1) Situation 1: The system displays "Collector connection error".

This is usually caused by failure of power supply or transmission lines on the "transmission board" (inside a small metal box beside the "L-shaped shelf"). Check the power plug on the "transmission board" to see whether it is loosened or poorly contacted, re-plug the power plug. Check the plug of transmission line to see whether it functions well, re-plug this cable plug and the cable plug on IPC board.

- 2) Situation 2: The system displays "Failure to open control panel communication".

This is usually caused by failure of data transmission line between control panel and industrial motherboard. Check the data line plug (DB9 plug) of COM1 port on the industrial motherboard and the data line plug (white plug of line 3) of J3 port on the control panel to see whether they are loosened or poorly contacted, if so, re-plug the data line plugs on the two ends.

Failure 4: Keys on the special-purpose keyboard won't work normally

If the equipment boots normally by the key switch and the start button on the special-purpose keyboard, but the motor key or image processing key won't work, then the failure is caused by data line communication problem on the COM2 port. Check the data line plug (DB9 plug) on the COM2 port of industrial motherboard.

Failure 5: The ray won't radiate normally

The conveyor runs normally but the ray won't radiate normally and the screen won't display images. Please check ON/OFF, XRAY_ON and POWER on the X-ray controller to see whether the indicator lights can light up normally (when inspection, push against the micro-switch and press the start button to recover the emergency stop state). Then press the emergency stop button and check whether the INTERFACE and POWER plug connection is loosened, if so, please re-plug the control line and check whether the equipment boots normally.

Failure 6: Illegal power failure

First disconnect the power supply line, then check the air switch for tripping. If the air switch is tripped, please redial it again. You have to wait one minute, reconnect the power supply line, and then reboot the security device as usual.

At this point the Windows computer starts, may start repair or normal start.

If you start from the repair into the system, you must external PC keyboard to click normal start –“Enter”, and then can enter the software interface.

If the normal start, then directly into the software, without click“Enter”.

