

User Manual

Off-Grid Solar Inverter

500W/1000W/2000W/2500W/3000W

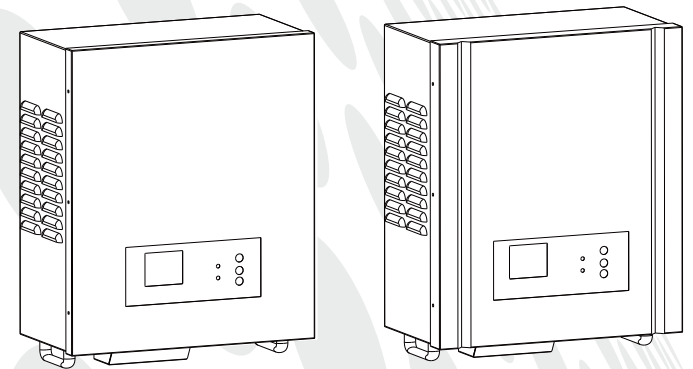

Table of Contents

1 Safety Information	1
1.1 Safety Instructions	1
1.2 Safety Precautions.....	1
2 Product Overview	3
2.1 Specifications.....	3
2.2 Panel Features	7
2.3 Outdoor Off-grid Solar Inverter Panel Features.....	9
3 Installation	11
3.1 Installation Precautions	11
3.2 Installation Location	11
3.3 Wiring.....	12
4 Operation Instructions	14
4.1 Turn ON/OFF	14
4.2 Emergency Shutdown Operations.....	14
4.3 Display Interface	15
4.4 Settings	15
4.5 Communication Interface.....	20
4.6 Operating Mode	20
5 Maintenance	26
5.1 Preventive Maintenance	26
5.2 Battery Maintenance	26
6 Troubleshooting	27

1 Safety Information

1.1 Safety Instructions



- Due to high voltage inside the inverter equipment, someone who is not a technician of or not authorized by the company shall not open the cabinet cover, otherwise risk of electric shock is possible and the eligibility of warranty will be lost.
- This equipment is an energy storage system, so please make sure energy storage battery is installed to ensure safe operation.
- Before using it for following loads, be sure to discuss with your dealer in advance, and special consideration and design shall be made for its application, setup, management and maintenance etc.
 - A medical instrument that is directly related to the patient's life;
 - Elevators and other equipment that may endanger personal safety;
 - Above equipment alike.

1.2 Safety Precautions

- When installing this product, please ensure that the monitor and TV are kept at a distance of 50 cm or more.
- The surface temperature of cabinet will rise by 50°C around during use of the product. This is a normal phenomenon.
- Please do not exceed the rated load capacity in use.
- Do not open the inverter housing, otherwise risk of electric shock or other hazards may be caused. For troubleshooting inside the device, please send it to the specified service center.
- Internal short circuit may lead to electric shock or fire. Therefore, to avoid such risks, container with liquid shall not be placed on the product.
- If the device is working abnormally, please turn off the power immediately and contact your dealer.
- Please do not store or use this product in following environments:
 - Places without air convection
 - Places where there are flammable gases, corrosive substances, or a large amount of dust
 - Places of abnormally high or low temperature (40 °C above or below 0 °C),

and high humidity (90% or more)

- Places in direct sunlight or near heating appliances
 - Places with intense vibration
 - Outdoor
- In case of fire around, please use dry powder fire extinguisher. Use of liquid fire extinguishers may pose a risk of electric shock.
- Please attach a miniature circuit breaker to the input end of the product, so that power plug can be disconnected from the outlet to turn off power in case of emergency.

Symbols	Descriptions
 <p data-bbox="153 707 253 730">Warning</p>	<ul style="list-style-type: none">• The equipment must be grounded, and as AC power supply is connected, be sure to ground the system reliably, and take care not to reverse the neutral wire and live wire.• Inverter has a high voltage inside. So, to ensure personal safety, please consult technical staff of this company for any questions.
 <p data-bbox="153 919 253 943">Caution</p>	<ul style="list-style-type: none">• Improper operation may cause enormous loss. Please be sure to operate the device according to instructions.• To ensure device safety and personal safety, it must be installed by professionals.

2 Product Overview

2.1 Specifications

Note: 2500W is for 110Vac series only, 3000W is for 220Vac series only.

Model		500W	1000W	2000W	2500W	3000W
Rated voltage		12Vdc	24Vdc	48Vdc		
Battery type		Pb-Acid				
Rated capacity		≥100AH	≥100AH	≥100AH	≥150AH	≥150AH
PV Input	Max. open circuit voltage	60Vdc	100Vdc	150Vdc		
	Optimum operating voltage (Vmp)	16-48Vdc	33-80Vdc	65-120Vdc		
	MPPT min. starting voltage	≥Ubat*1.25				
	MPPT shutoff condition	Ppv≤10W and Upv≤Ubat*1.1				
	MPPT max. charging efficiency (DC/DC conversion efficiency)	≥98%				
	Max. charging current	50A	50A	50A	65A	65A
	Recommended electrode plate power	750W	1400W	2800W	3500W	3500W
Mains input	Bypass voltage operating range	0-264Vac for 200/220/230/240Vac				
	Input voltage range	100V/110V/115/120V or 200/220V/230V/240V±25%				
	Input frequency range	50/60Hz±10%±1Hz (5%/15% can be set)				
	Max. charging current	20A	20A	20A	30A	30A
Output	Inverter output	100V/110V/115V/120V or 200V/220V/230V/240V±2%				

param eters	voltage						
	Stable output voltage range		100V/110V/115V/120V or 200V/220V/230V/240V±10%				
	Bypass output voltage range		Same as input voltage range				
	Conversion time (AC to DC)		Typical: 4 ms, Maximum: 10 ms				
	Rated power (W)		500W	1000W	2000W	2500W	3000W
	Power factor		1				
	Rated output frequency		50/60 Hz ± 1% (Inverter mode)				
	Overload protection (linear load)		≥110% for 2 min (power off without mains input) ≥125% for 1 min (power off without mains input) ≥150% for 10 s (power off without mains input) ≥180% loads, power off after 1 s.				
	Max. inverter output efficiency (resistive load)		≥78%	≥85%	≥85%	≥85%	≥85%
	Sleep mode load rate		≤3%--50% can be set, enter sleep mode after 2 min.				
	Output voltage harmonics		≤3% (linear load)				
	Inductive load		Yes (≤30%)				
	Half wave load		Yes (≤20%)				
Batter y manag ement	Rated battery voltage		12V	24V	48V		
	Charging current (setting available)		5-50A	5-50A	5-50A	5-65A	5-65A
	Charging current (setting available)		Lead acid battery: 6 cells Lithium battery: 4 cells	Lead acid battery: 12 cells Lithium battery: 8 cells	Lead acid battery: 23/24 cells Lithium battery: 14/15/16 cells		
	Equalizing charge voltage	LEAD	13.8-15V 14.1V (Default)	27.6-30.0V 28.2V (Default)	55.2-60V 56.4V (Default)		
		LIT	14.0-15.2V 14.6V (Default)	28.0-30.4V 29.2V (Default)	56-60.8V 58.4V (Default)		





	GEL	13.8-15.0V 14.4V (Default)	27.6-30.0V 28.8V (Default)	55.2-60.0V 56.4V (Default)
	AGM	13.8-15.0V 14.4V (Default)	27.6-30.0V 28.8V (Default)	55.2-60.0V 56.4V (Default)
	Flood	13.8-16.2V 15.0V (Default)	27.6-32.4V 30.0V (Default)	55.2-64.8V 60.0V (Default)
	Other	13.8-15V 14.1V (Default)	27.6-30.0V 28.2V (Default)	55.2-60V 56.4V (Default)
Floating charge voltage	LEAD	13.2-13.8V 13.6V (Default)	26.4-27.6V 27.2V (Default)	52.8-57.6V 54.4V (Default)
	LIT	13.6-14.8V 14.2V (Default)	27.2-29.6V 28.4V (Default)	54.4-59.2V 56.8V (Default)
	GEL	13.2-13.8V 13.5V (Default)	26.4-27.6V 27.0V (Default)	52.8-57.6V 54.0V (Default)
	AGM	13.2-13.8V 13.6V (Default)	26.4-27.6V 27.2V (Default)	52.8-57.6V 54.4V (Default)
	Flood	13.2-14.4V 13.8V (Default)	26.4-28.8V 27.6V (Default)	52.8-57.6V 55.2V (Default)
	Other	13.2-13.8V 13.6V (Default)	26.4-27.6V 27.2V (Default)	52.8-57.6V 54.4V (Default)
Battery under-volt age point (DOD)	LEAD	10.5-13.2V 12.0V (Default)	21.0-26.4V 24.0V (Default)	42.0-52.8V 48.0V (Default)
	LIT	10.4-14V 12.4V (Default)	20.8-28.0V 24.8V (Default)	41.6-56.0V 49.6V (Default)
	GEL	10.5-13.2V 12.0V (Default)	21.0-26.4V 24.0V (Default)	42.0-52.8V 48.0V (Default)
	AGM	10.5-13.2V 12.0V (Default)	21.0-26.4V 24.0V (Default)	42.0-52.8V 48.0V (Default)
	Flood	10.5-13.8V	21.0-27.6V	42.0-55.5V

		12.6V (Default)	25.2V (Default)	50.4V (Default)
	Other	10.5-13.2V 12.0V (Default)	21.0-26.4V 24.0V (Default)	42.0-55.0V 48.0V (Default)
Battery end of discharge point (EOD)	LEAD	9.6-12.0V 10.5V (Default)	19.2-24.0V 21.0V (Default)	38.4-48.0V 42.0V (Default)
	LIT	9.2-10.8V 10.0V (Default)	18.4-21.6V 20.0V (Default)	36.8-43.2V 40.0V (Default)
	GEL	9.6-12.0V 10.5V (Default)	19.2-24.0V 21.0V (Default)	38.4-48.0V 42.0V (Default)
	AGM	9.6-12.0V 10.5V (Default)	19.2-24.0V 21.0V (Default)	38.4-48.0V 42.0V (Default)
	Flood	9.6-12.0V 11.4V (Default)	19.2-24.0V 22.8V (Default)	38.4-48.0V 45.6V (Default)
	Other	9.6-12.0V 10.5V (Default)	19.2-24.0V 21.0V (Default)	38.4-48.0V 42.0V (Default)
Overcharge protection point (V)		Equalizing charge voltage*1.1		
Overcharge recovery point (V)		Equalizing charge voltage		
Others	Power saving mode load rate	≤3-50% can be set, default rate is 3% (can reduce loss by 85%)		
	No-load shutdown load rate	≤3-50% can be set, default rate is 3%		
	Protection functions	Output overload, output short circuit, battery over-discharge, battery overcharge, battery reversed polarity, PV reversed polarity, over temperature		
	Lightening protection level	Level III		
	Noise reduction function	Automatic		
	Battery reversed polarity	Buzzer generates a long sound		

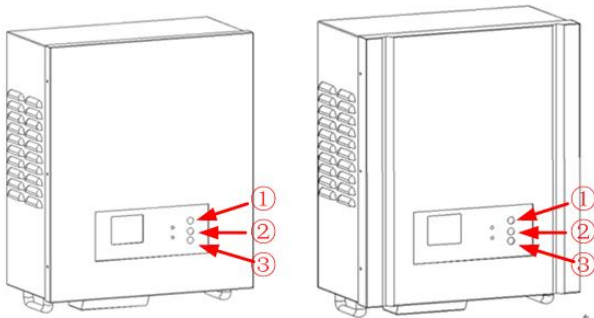
Class of Pollution	II				
IP Rating	IP21				
Operating temperature	0°C-40°C				
Operating humidity	Relative humidity ≤ 93%				
Noise	<50dB				
Communication interface	RS232, RS485, USB, SNMP(optional), remote control of switching from inverter mode to bypass mode, inverter or power-off				
Dimensions (mm) W*D*H	365.5x442x210				
Package dimensions (mm) W*D*H	455x520x280				
Net weight (KG)	16.6	19.5	30.4	32.8	38.5
Gross weight (KG)	18.1	21.0	31.9	34.3	40.0
Outdoor Off-grid Solar Inverter	Net weight (KG)	/	/	/	73.6
	Gross weight (KG)	/	/	/	83.1

2.2 Panel Features



① Power ON button “  ”	③ Page up/down button “  ”
② Power OFF button “  ”	④ LCD display interface
 +  Enter settings interface / Force quit settings interface	

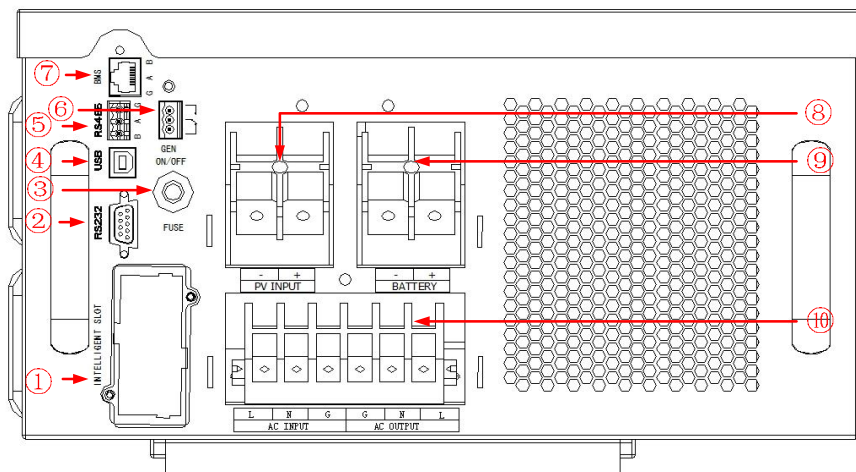
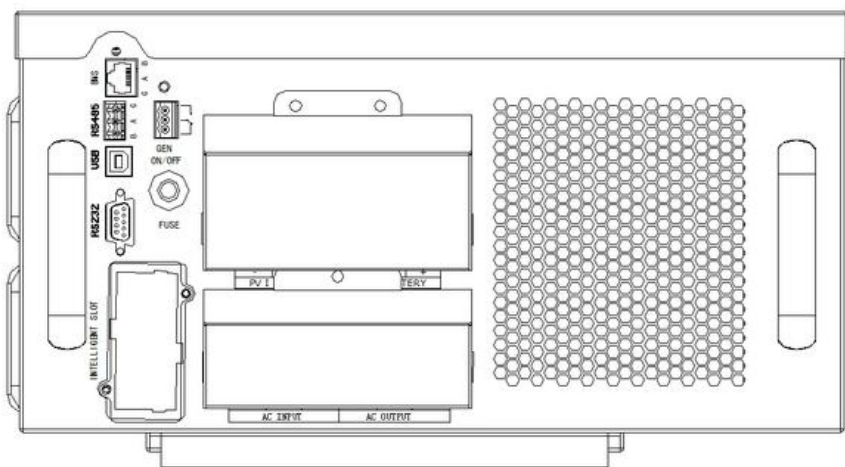

① Smart Card Slot	⑥ Generator Dry Contact Interface
② RS232 Interface for Communication	⑦ BMS Interface
③ Over-current Protection Circuit Breaker	⑧ PV Input Wire Terminal Block
④ USB Interface for Communication	⑨ BAT Input Wire Terminal Block
⑤ RS485 Interface for Communication	⑩ AC Input/Output Wire Terminal Block

2.3 Outdoor Off-grid Solar Inverter Panel Features

2000/2500/3000W:

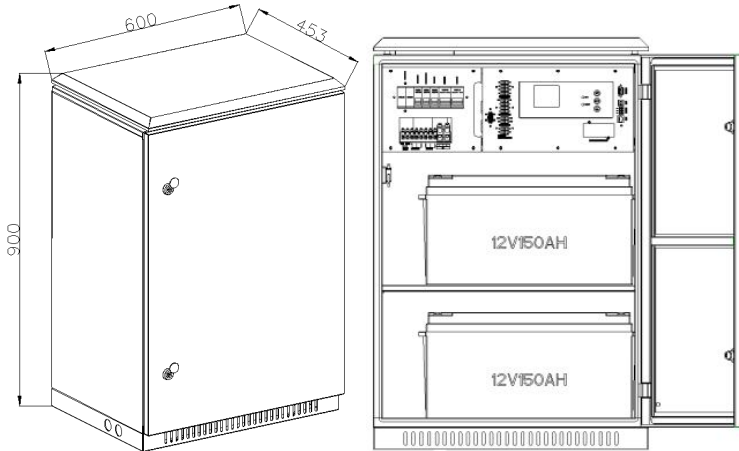

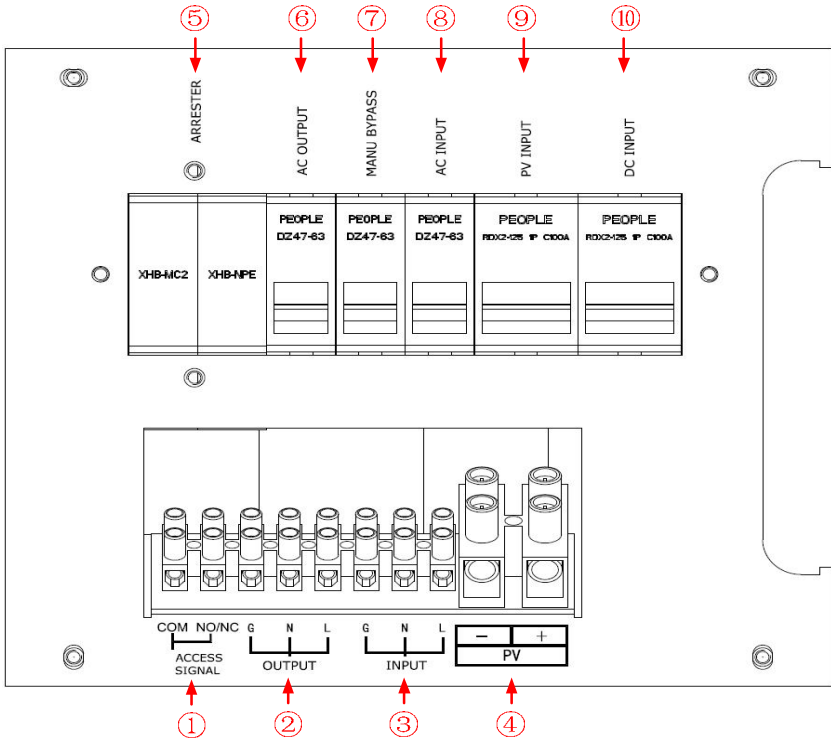

Introduction of connecting terminals:

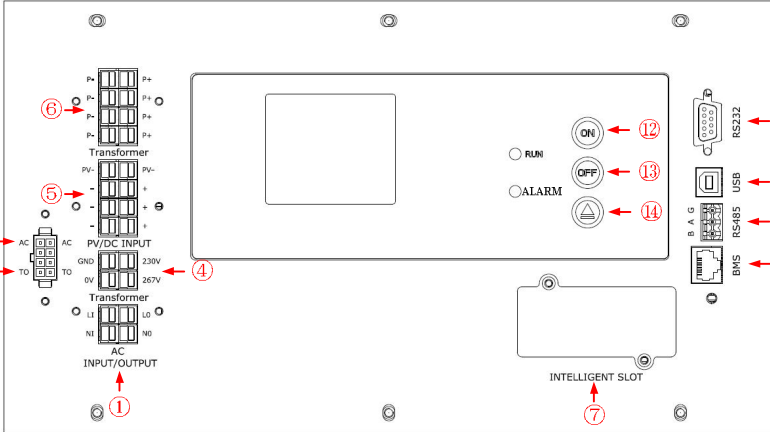

① Access signal terminals	② AC output terminals
③ AC input terminal	④ PV input terminal
⑤ SPD	⑥ AC output breaker
⑦ bypass breaker	⑧ AC input breaker
⑨ PV input breaker	⑩ battery breaker

Introduction of front panel:



① AC input and output connector. LI/ NI means input, LO/NO means output.	② transformer over temperature detection
③ door open detection	④ Connector of 0V/230V/267V and ground from transformer.
⑤ PV-, battery + and battery - connector	⑥ Connector to transformer primary
⑦ Smart Card Slot	⑧ BMS Interface
⑨ RS485 Interface for Communication	⑩ USB Interface for Communication
⑪ RS232 Interface for Communication	⑫ Power ON button “ON”
⑬ Power OFF button “OFF”	⑭ Page up/down button “▲”
 +  Enter settings interface / Force quit settings interface	

3 Installation

3.1 Installation Precautions

- On-site installation must be performed under the guidance of a authorized professional engineer of our company;
- When carrying out electrical connection, you shall connect the ground wire of inverter first; and make sure that all the switches are turned off before the inverter is installed.
- Installation of the inverter shall be in accordance with the requirements of this manual in conjunction with local setting and use standard.
- Please remove ring, bracelet, watch and other medal ornaments worn on your hands when connecting the battery. Please use tools with insulated handle. In case of electrolyte leak or battery damage, the battery must be replaced and placed in a sulfuric acid-resistant container and disposed according to local regulations. If your skin comes into contact with the electrolyte, please rinse immediately with water.

3.2 Installation Location

Following requirements shall be noted when selecting the installation space for inverter:

- Put the product in a ventilated place and ensure that the cooling holes and fan of the housing has a ventilation distance of more than 150 mm.
- The inverter must be installed and used in a clean and dry indoor environment (ambient temperature: 0 ~ 40 °C, relative humidity: 5% to 90%; the best operating temperature is 25 °C). If the indoor temperature reaches 40°C, it is recommended to outfit an air conditioning or enhance ventilation facility.
- When the altitude is over 1000 meters, please use by derating.
- The system shall be attached indoors to the wall or other suitable positions with adequate load-bearing capacity (For the user's convenience in use, height should be ≥ 1.6 meters).

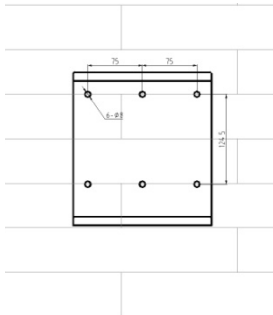

Mounting Hole Size

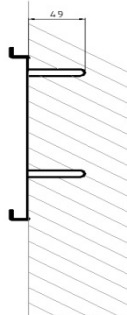

Mounting Hole Depth

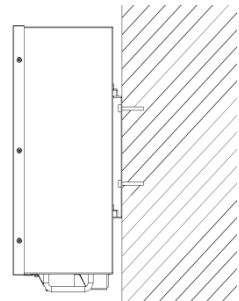

Installation Drawing

3.3 Wiring

3.3.1 Prepare For Cables

When designing external wiring cables, you shall consider power, current capacity and the requirement for system's overload capacity, as well as ambient temperature and physical support. To this end, the following table is made to give a suggestion for selection of a reasonable cross section size of the cable. Installation engineer shall carry out comprehensive selection in reference to relevant local standards and the following table. Generally, the length of a connecting cable is 2-10 m. Too long cable will cause voltage drop, resulting in corresponding increase of cable cross-section.

Name	Rated capacity	500W	1000W	2000W	2500W	3000W
	Wire grade					
220VAC input and output wire diameter (L+N+G)	GB/T (mm ²)	≥0.75	≥0.75	≥1.5	/	≥2.5
	AWG	≥18	≥18	≥16	/	≥16
110VAC input and output wire diameter (L+N+G)	GB/T (mm ²)	≥0.75	≥1.5	≥2.5	≥4	/
	AWG	≥16	≥14	≥12	≥10	/
Battery input wire diameter	GB/T (mm ²)	≥12	≥12	≥12	≥16	≥16
	AWG	≥6	≥6	≥6	≥4	≥4
PV input wire diameter	GB/T (mm ²)	≥10	≥10	≥10	≥12	≥12
	AWG	≥8	≥8	≥8	≥6	≥6

3.3.2 Connect Cables

When an appropriate mounting position is selected, the 3 screws on the cover of terminal block as shown in the block diagram below need to be removed to remove the cover and then wiring can be started. Please connect respectively the battery, PV, AC input and output cables according to the corresponding screen print on the terminal block.

Terminal block diagram

Marking		Description
AC OUTPUT	"L"	Load output live wire (L)
	"N"	Load output neutral wire (N)
	"G"	Load output neutral wire (N)
AC INPUT	"G"	Mains input ground wire (G)
	"N"	Mains input neutral wire (N)
	"L"	Mains input live wire (L)
PV INPUT	"+"	PV input wiring terminal "+" polarity
	"-"	PV input wiring terminal "-" polarity
BATTERY	"+"	Battery input wiring terminal "+" polarity
	"-"	Battery input wiring terminal "+" polarity

System wiring diagram

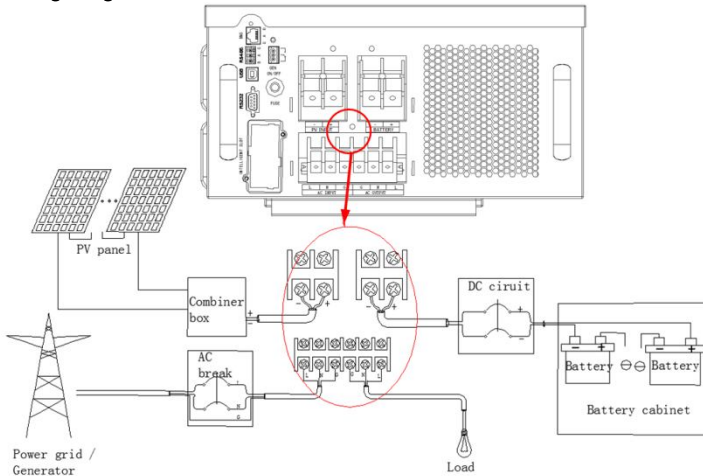

Note: select a suitable battery wire to connect the battery and inverter, and a DC air switch (80A ~ 125A) has to be fitted between the Inverter and battery.



4 Operation Instructions

4.1 Turn ON/OFF

Cautions

When the wiring is completed, please turn on the inverter according to the specified procedures; if the inverter fails to be turned on, please immediately switch off all input power, and then contact the manufacturer.

Turn On Procedures

- DC cold start: the inverter is only connected to the battery; press the ON/OFF button  for 3 seconds and then the system powers on; after 15 seconds, the inverter normally supplies power to the loads.
- Routine start: press the ON/OFF button  for 3 seconds and then the system powers on; the inverter normally supplies power to the loads.

Turn Off Procedures

- Press a button to turn off: when the inverter is running, press the ON/OFF button  for 3 seconds and the system powers off; after it enters the initialization mode, turn off the inverter PV input switch, mains input switch and battery input switch.

4.2 Emergency Shutdown Operations

- Directly disconnect the loads, then disconnect the PV input, and then disconnect the mains input, and finally disconnect the battery.
- If the product has been not used for more than 3 months, please turn on the PV input switch or mains input switch to power on the system and charge the battery for at least 12 hours so as to prolong battery life.

WARNING: the instantaneous impact current of RCD loads comes with uncertain factors. Therefore, overload running is strictly prohibited.

4.3 Display Interface

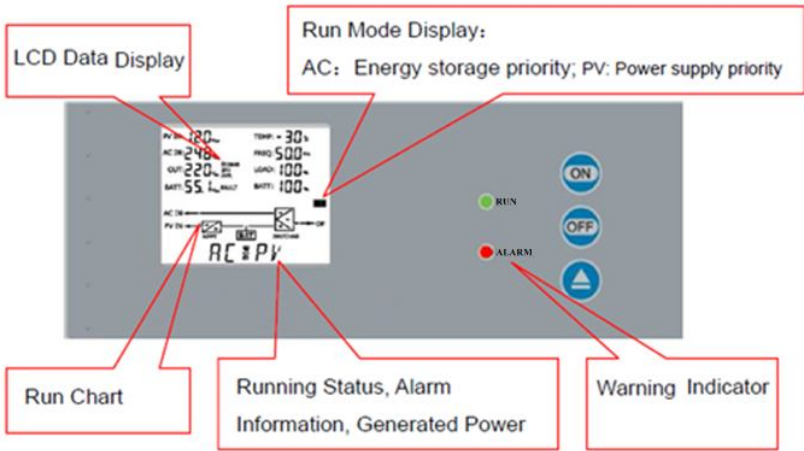





















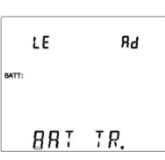



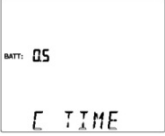



Indicator	Indicator status	Description	Buzzer status
ALARM (Red)	Illuminated continuously	<ul style="list-style-type: none"> Output over current, short circuit protection Over temperature protection System over voltage protection 	Beep one time every 1 second
	Flash one time every 2 seconds	Overload, battery under-voltage	Beep one time every 2 seconds
RUN (Green)	Illuminated continuously	Inverter non-bypass output	/
	Darken	Inverter bypass output	/









4.4 Settings



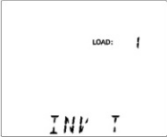



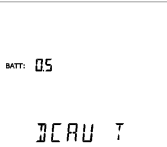

Press the “ON” button + “Page Flip” button for 3 seconds to enter the LCD setting interface. After entering the LCD setting interface, press the “ON” button to perform a setting of parameters increase, press the “OFF” button to perform a setting of parameters decrease and press the “Page Flip” button to switch setting items; press the “ON” button + “Page Flip” button for 3 seconds again to exit setting interface; press the “Page Flip” button to switch to “SAVE” interface, and press the “ON” or “OFF” button to switch to “YES” to save the current settings and exit the setting interface.

Note: For the setting options that cannot come into effect in real time, fully turning the power off after saving and exist is required to take effect.

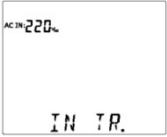
Operations	Press  or  to select setting items	LCD display	Effectiveness (When to take effect)
 + 	OUT: Rated output voltage 100V/110V/115V/120V, default 110V 200V/220V/230V/240V, default 220V		After restart
	INPOWE: Generator input power ratio setting (10% -120%), the default is 120%. When the generator power ≤ system rated power, such setting is needed; Set value = generator power / UPS power / 1.1 (safety factor) * 100%.		Immediately
	FREQ: Rated output frequency setting, 50HZ/60HZ can be set, the default is 50HZ.		After restart
	RANG: Input frequency range setting: (± 5% - ± 15%) can be set, the default is ± 10%.		After restart
	BAT TP: Battery type setting: LEAD (Enclosed maintenance-free battery) /LIT (Lithium iron phosphate battery) /GEL (Gel battery) /AGM (Absorbent glass mat battery) Flood(flood battery)/others.		After restart
	CYCLE: Equalizing charge voltage setting (2.30V-2.50V / CELL), * number of cells can be set, the default is 2.36 * unit number.		Immediately
	C TIME: Constant voltage charging time setting (H), the default is 0.5 hour.		Immediately

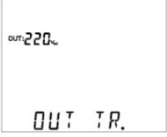
	<p>FLOAT: Floating charge voltage setting (2.20V-2.30V / CELL), * number of cells can be set, the default is 2.27 * unit number.</p>		<p>Immediately</p>
	<p>DOD: Depth of discharge setting (1.75V-2.20V / CELL), * number of cells can be set, the default is 2.0 * unit number.</p>		<p>Immediately</p>
	<p>EOD: End of discharge voltage setting (1.60V-2.00V / CELL), * number of cells can be set, the default is 1.75 * unit number.</p>		<p>Immediately</p>
	<p>CHARGE: Charging current setting 500-2000W: settable in 5-50A, the default is 20A 3000W: settable in 5-65A, the default is 20A</p>		<p>Immediately</p>
	<p>IECO: Power saving mode selection (ON/OFF) default OFF; if "ON" is selected, in case of DC power supply and a low load rate of ≤3%, system will enter the sleep mode which can reduce an energy loss by 90%; Add loads by more than 3% after entering sleep mode, the system will automatically wake up. (When the power saving mode and the auto off function are opened at the same time, the system default is the power saving mode).</p>		<p>Immediately</p>
	<p>INLS: Auto Off function selection (ON/OFF) default OFF; if "ON" is selected, please confirm the "INLS (UPS power off load rate)" is in the setting range and the system will power off after the set time (INV T). The load rate that has been set should meet the actual requirements; if not appropriate, please change (only DC power supply is valid).</p>		<p>Immediately</p>

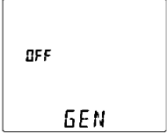
	<p>LOAD: UPS auto off load rate setting (3%-50%) default 3%; In service, the load rate that is required for power off on site shall be set (only DC power supply is valid).</p>		<p>Immediately</p>
	<p>INV T: UPS auto off delay time setting (1-99 minutes) default 1 minute; when the load rate ≤ set value, the system will power off after the set time (only battery mode is valid).</p>		<p>Immediately</p>
	<p>ACAUTO: AC auto power on function selection (ON/OFF), default "ON"; if "OFF" is selected, when the UPS is off after discharge of battery, it will not automatically restart when the mains power is restored.</p>		<p>Immediately</p>
	<p>DCAUTO: DC auto power on function selection (ON/OFF); if "ON" is selected, when the system powers off after over discharge, it will be in standby mode. After the standby time ≥ DC automatic start delay time, if the external charge capacity ≥ 50% of the system rated capacity, the system will automatically power on (this function is perfect for a combined solar system or a system with external charging devices).</p>		<p>Immediately</p>
	<p>DCAU T : DC auto power on delay time setting (0.5H-8.0H); it is, after the system powers off due to over discharge. the minimum time the external charger charges the battery. (This function is perfect for a combined solar system or a system with external charging devices).</p>		<p>Immediately</p>

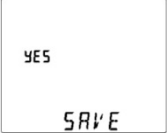
	<p>MODE: Run mode setting: SAVPRI (energy storage with priority) and GENPRI (power supply with priority) mode selection.</p>		<p>Immediately</p>
	<p>IN TR: Input voltage display setting, (200-240V model: OFF/100/110/115/120; 100-120V model: OFF/200/220/230/240), default "OFF"; display the current rated voltage of the system; if "100/.../240" is selected, input voltage will be displayed as "100V/.../240V", transformation ratio of the transformer is "set voltage: rated voltage value".</p>		<p>Immediately</p>
	<p>OUT TR: Output voltage display setting, (200-240V model: OFF/100/110/115/120; 100-120V model: OFF/200/220/230/240), default "OFF"; display the current rated voltage of the system; if "100/.../240" is selected, input voltage will be displayed as "100V/.../240V", transformation ratio of the transformer is "set voltage: rated voltage value".</p>		<p>Immediately</p>
	<p>This setting is used to identify the generator as the inverter is connected to the generator with AC input; Set "OFF" not to identify, and set "ON" to identify the generator.</p>		<p>Immediately</p>
	<p>SAVE: Save and discard selection (YES / NO) default NO; select "YES" to save the modification information, and select "NO" to discard the changes and continue to set.</p>		<p>Immediately</p>

4.5 Communication Interface

The inverter comes with a variety of communication interfaces including USB, RS232, RS485, SNMP card, BMS and dry contact interface; communication mode is choosing 1 from 4, instead of use of more than two kinds of communication interfaces at the same time; the inverter comes standard with USB, RS232, RS485 communication cables and SNMP card slot.

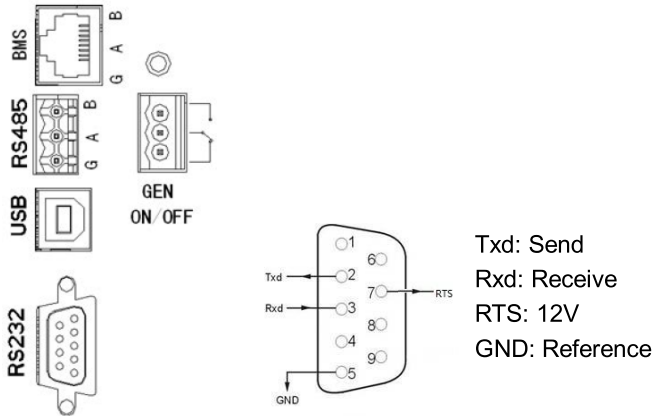

4.6 Operating Mode

4.6.1 System Operating Mode

- Energy storage as a priority: In this mode, the priority of the system is that PV module is firstly used to charge the battery and secondly charge the loads; when the PV energy is not enough, loads are charged by PV+AC together. If AC power supply is found abnormal, the loads will be powered by PV + battery.
- Power supply as a priority: In this mode, the priority of the system is that PV module is firstly used to charge the battery and secondly charge the loads; when the PV energy is not enough, loads are charged by PV+AC together. When the battery discharges to DOD point, the system switches to AC power supply, and the battery is charged by PV. If there is excess energy in PV charging, PV and AC together supply power to the loads and AC does not charge the battery; as the battery is fully charged (enter floating charge), the system switches back to PV power supply.

1) Energy storage as a priority

- Daytime, with sufficient sunlight and normal mains input: the solar panel is adjusted to the maximum power supply capacity through the solar controller and supplies the power to loads via the inverter (mains input standby) while charging the battery, with AC input switched off (as shown in the block diagram below);

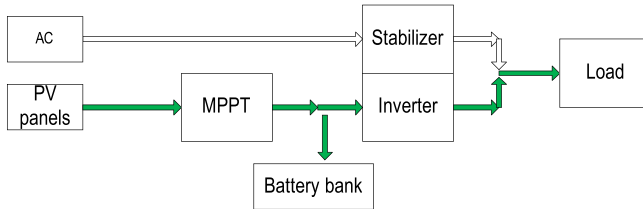

- Daytime, with insufficient sunlight and normal mains input: the system powers the loads with AC mains input via the voltage stabilizer and PV module is connected to charge the battery with excess energy used to power the loads (as shown in the block diagram below);

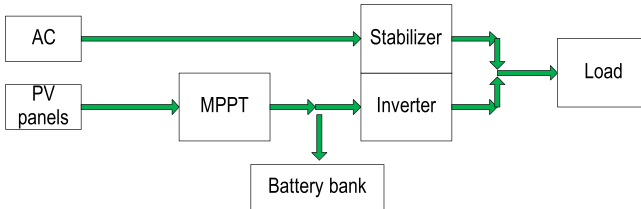

- Nighttime (or rainy day without sunlight), with normal mains input: the system powers the loads with AC mains input via the voltage stabilizer and at the same time charge the loads:

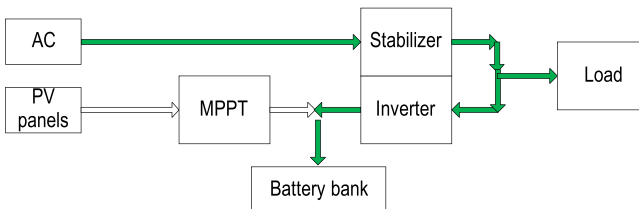

2) Power supply as a priority

- Daytime, with sufficient sunlight and normal mains input: the solar panel is adjusted by the solar controller to the maximum power supply capacity and power the loads via the inverter (mains input standby) while charging the battery, with AC input switched off (as shown in the block diagram below);

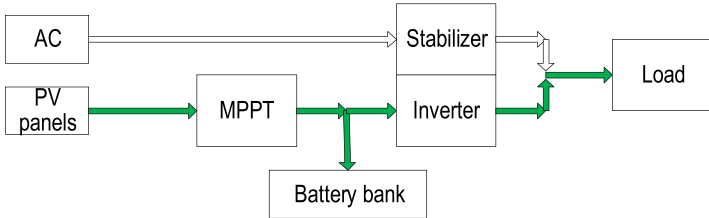

- Daytime, with insufficient sunlight and normal mains input:
 - ♦ Battery voltage $>$ DOD: system supplies power to the loads via PV module and battery (as shown in the block diagram below);

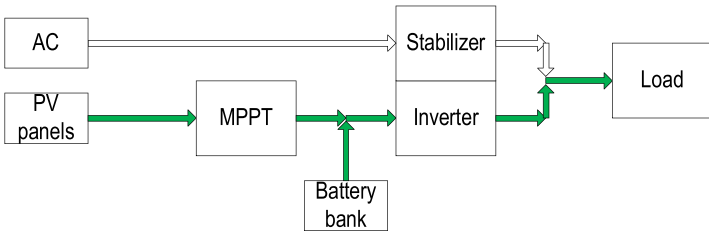

- ♦ Battery voltage \leq DOD: loads are powered by AC mains input and the battery is charged by PV module (as shown in the block diagram below); if charging does not use up the power from PV, loads are powered by PV+AC together and AC mains is disconnected until the battery is fully charged (enter floating charge).

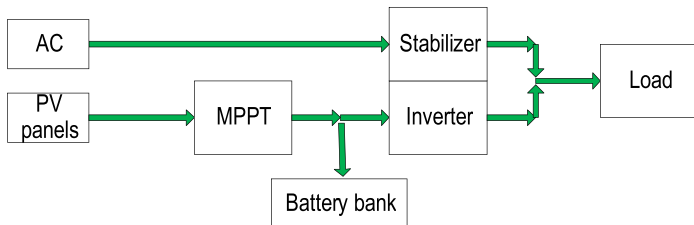

3) After battery discharge is completed and the mains recovered, the system automatically powers on

- In the energy storage priority mode, the load is powered by the AC input through the voltage stabilizer while the battery is charged (as shown in the block diagram below);

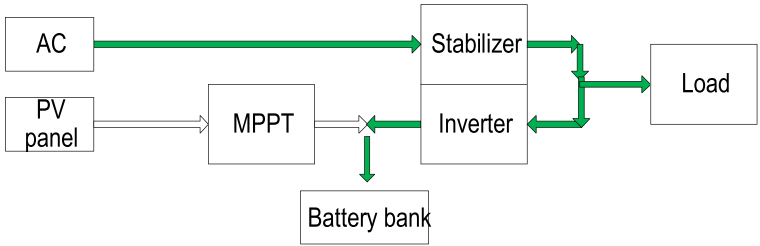

- In the power supply priority mode, the load is powered by the AC input through the voltage stabilizer while the battery is charged to DOD point before the charger is turned off (as shown in the block diagram below);

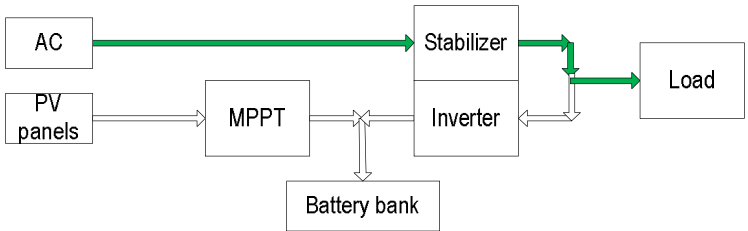

4) The system is not turned on or overloaded, the bypass will power the load while PV module only charges the battery

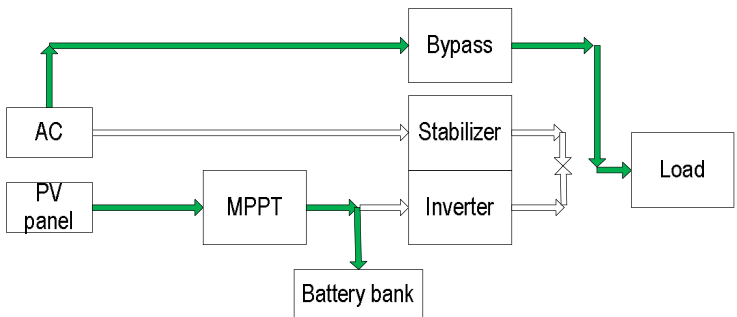

4.6.2 Operating Mode Description

LCD displays operating modes

Operating modes	Displayed character	Description
PV normal mode	PV	With sufficient power, PV module powers the loads through the MPPT and inverter (mains standby), while charging the battery(grid off or Power supply as a priority mode)
PV and AC complementary mode	PV*AC	In the case of insufficient sunlight and normal mains input, the PV input and AC input are complementary. At this time, the system powers the loads with AC mains input via the voltage stabilizer and PV module charges the battery with excess energy used to power the loads.
PV and BAT complementary mode	PV*BAT	In the case of insufficient sunlight, abnormal mains input or power supply priority mode, PV module and battery are complementary in power supplying, and this time the loads are powered by the PV module and battery together.
AC power supply mode	AC	When the battery is discharged, and the power from the PV module is not enough, in the case of AC charging not permitted, the system will run in AC power supply mode. At this point, the load is powered by AC input through the voltage stabilizer, whereas the battery is not charged by that.
Battery power supply mode	BAT	When the PV module and AC (utility) are abnormal, the system will enter the battery power supply mode where the loads are powered by battery.
Battery test mode	TEST	When the user sends a test signal, the system will enter the test mode where the loads are powered by battery.
Bypass mode	BYPASS	When the system is not turned on or overloaded, the system will enter the bypass mode where the load is powered by the bypass.

Shutdown mode	SHUTDN	This mode appears when there is a PV input or AC input after the mains, PV module and battery execute a shutdown command.
Standby mode	NONE	When the system executes a command to wait for power on (countdown), it will enter this mode, where there is a bypass output as the system is connected to the mains.

Special operating mode

When the generator mode is set as ON, the system operates in “power supply priority” mode.

5 Maintenance

5.1 Preventive Maintenance

Preventive maintenance carried out for the inverter system ensures high inverter reliability and long service life.

Following inspections can be performed every month:

- Turn off the inverter (see details in operating procedures);
- Inspect to confirm the ventilation holes are not blocked;
- Inspect if there is a large amount of dust on the cover;
- Make sure the product is put in dry places avoiding being affected with damp;
- Turn the power on (Power on/off);

5.2 Battery Maintenance

Battery life relies on the storing and operating environment; increase of discharge frequency and degree as well as temperature will shorten the battery life rapidly. It is recommended to minimize discharge frequency and discharge depth of the battery. Dust handling:

- Remove dust and dirt on the battery.
- Check if the internal wiring between battery cells is loose or corroded and replace and repair if necessary.
- Make sure the battery and battery terminals are tightened.

Note: In order to better protect the battery, the system logic set is that when the battery discharges to EOD point, inverter is only turned on under energy storage mode and the mains is connected; it is normal that the inverter is not turned on in other cases.

6 Troubleshooting

➤ **Abnormal information query and handling** (press  to flip over)

No.	LCD display	Abnormal items	Troubleshooting solutions
1	SHORT	Inverter output short circuit	Check if the load is short circuited, the system is severely overloaded, or the inductive load rate exceeds 30%.
2	RELAY	Relay fault	Frequent fluctuation of power grid (utility) leads to the end of life of relay, so please contact the supplier.
3	LOAD	System output overload	Check the loads and do not use the system until load rate is decreased.
4	PV V H	PV over voltage	PV input voltage overruns. Check if the PV input voltage overruns; if not, please contact the supplier;
5	SENSOR	MOS tube temperature probe is not connected	Check if the internal wires are loose due to vibration. Fasten the wire connecting.
6	MOS C	MOS tube over current	Check if the load is short circuited, overloaded, or the inductive load rate exceeds 30%. After load shedding, if the abnormal situation still exists, please contact the supplier.
7	MOS T	MOS tube over temperature/transformer over temperature	Is the fan abnormal? Is the ambient temperature $\geq 40^{\circ}\text{C}$? If not, reduce load running; if problem still exists, please contact the supplier.
8	PV MOS T	PV MOS over temperature	Is the fan abnormal? If not, please check if the power of PV panel exceeds given maximum power, and lower the power of panel connecting.
9	EOD	Battery low voltage shutdown	Check if the battery is fully discharged or the damaged; charge the battery for 12 hours or replace it.
10	INV H	Inverter high voltage	The inverter is abnormal, please contact the supplier.
11	INV L	Inverter low voltage	The inverter is abnormal, please contact the supplier.

12	SOFT	Inverter soft-start fault	Check if the connection between the transformer and the power board is reliable. If there is no abnormality, please contact the supplier.
13	BUS H	BUS high voltage (In charging, battery is overcharged)	Restart the inverter; if it is still abnormal, please contact the supplier.
14	CHARGE	Charge over current	Restart the inverter; if it is still abnormal, please contact the supplier.
15	BAT H	Battery over voltage	Check if the battery voltage and cell number meet product specifications.
16	SPS S	Auxiliary power failure	The inverter is abnormal, please contact the supplier.

➤ **Common faults and handling**

Use the table below to solve minor operation problems.

If the problem still exists, please contact the dealer or supplier.

Problem	Solution
The mains input is normal while the inverter has no access to the mains.	Please confirm if the system is set as “power supply priority” or “generator mode ON”. If yes, when the battery voltage is higher than DOD voltage, the system will run in PV + battery mode; if not, please check if the power cord, over-current protection device is connected.
System is unable to power on with only connection to battery and the buzzer generates a long alarm sound.	Battery wires are reversely connected. Rectify it and restart the system.
There is no display of PV voltage, the PV module is unable to be connected	Wires are reversely connected. Rectify it and retry the connection.
When the “ON” button is pressed, the system cannot start up.	<ol style="list-style-type: none"> 1. Pressing time is too short; please press the “ON” button for more than 3 seconds to start the inverter. 2. Check if the battery is not connected or the voltage for battery connection does not meet the system requirements. 3. If there is a malfunction inside the inverter, please contact the supplier.