



Fiber Optical Splice Closure

FOSC-220J-C104

User Manual

Version: A

FIBERHOME TELECOMMUNICATION TECHNOLOGIES CO., LTD

September 2019

Content

1 PRODUCT STRUCTURE.....	1
1.1 MAIN PART.....	1
1.2 SPLICE TRAY.....	1
2 APPLICATION.....	2
3 SPECIFICATION.....	2
4 INSTALLATION ACCESSORIES.....	2
5 INSTALLATION INSTRUCTIONS.....	3
5.1 INSTALLATION OF FLOW CHART.....	3
5.2 OPEN THE SPLICE CLOSURE.....	3
5.3 PROCEDURE OF CABLE STRIPPING.....	4
5.4 INSTALL THE FEEDER CABLE.....	5
5.5 OPERATION OF THE DISTRIBUTION CABLE.....	7
5.6 FIBER SPLICING AND STORAGE.....	7
6 INSTALLATION OF THE SPLICE CLOSURE.....	8
6.1 WALL-MOUNTING.....	8
6.2 POLE-MOUNTING.....	9

1 Product Structure

1.1 Main part

FOSC-220J-C104 is a type of hat type fiber optic splice closure. The main function of this product is to provide direct connection and branch for types of optical cables and connecting protection for related adapters in optical transmission link. The protection grade is IP68. There are four round cable entrances and an elliptical one which is for uncut cables. Take the vulcanization forming rubber as the sealing component and adopt spiral compression & vertical compression mechanical seal, this product is applicable to different kinds of branch connection, including uncut cable branch. It supports many installation methods: aerial, pole-mounting, wall-mounting, pipe-line, well and ground-burial. This splice closure owns excellent sealing function, easy to operate and can be widely applied. It is your priority choice over the optical connection products.

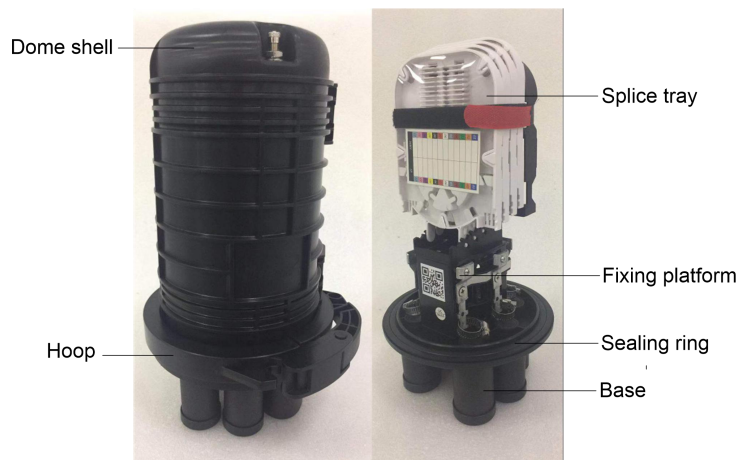

Figure 1-1

1.2 Splice tray

Splice trays are used for fiber splicing and storage, has the function of turning up and limiting position.

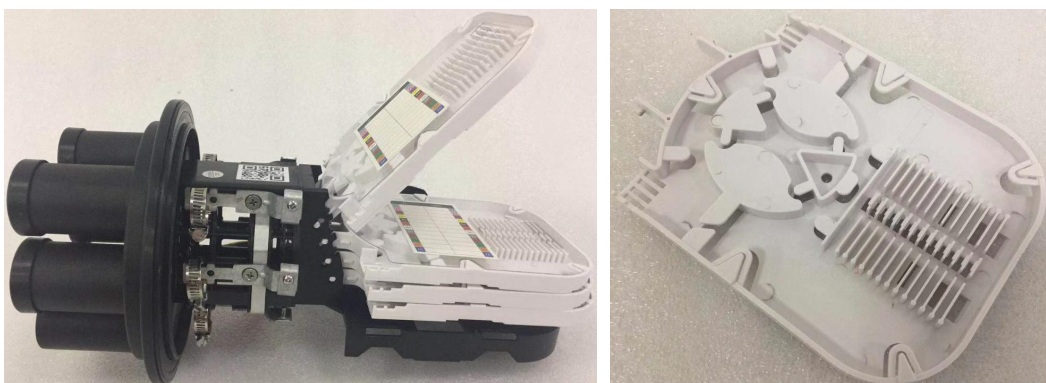

Figure 1-2

2 Application

FOSC-220J-C104 dome type closure with heat shrinkable is widely used in many applications, such as aerial, pole-mounting, wall-mounting.





3 Specification





The specification of FOSC-220J-C104 closure is shown as the following table.

Item	Specification
Dimension(mm)(D x L)	Φ220 x 360
Splice tray capacity	12F (extensible to 24F)
Max number of splice tray	4 pcs
Max capacity (single fiber)	48 cores (extensible to 96F)
Sealing mode	Mechanical sealing
Temperature range(°C)	-40~+65
Main cable diameter maximum	18mm
Color	Black

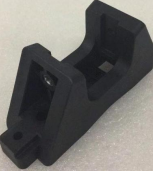
4 Installation accessories

The self-supplied installation tool for FOSC-220J-C104 closure is shown as the following table.

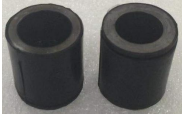
No.	Accessory	Picture	Function
1	Nylon cable tie		Tie up the fiber protective tube and the loose tubes
2	Fiber splice protective sleeve		Protect fiber splice contacts
3	Bare fiber protective tube		Manage bare fibers
4	Black insulation tape		Protect grounding wire
5	Clamp		Fix the splice closure

No.	Accessory	Picture	Function
6	Plastic expansion bolt		Wall installation
7	The distribution cable port cover		Dustproof
8	Plug		Seal cables
9	Mechanical seal assembly		Seal cables

5 Installation Instructions

5.1 Installation of flow chart

Installation of flow chart is shown in the following chart.

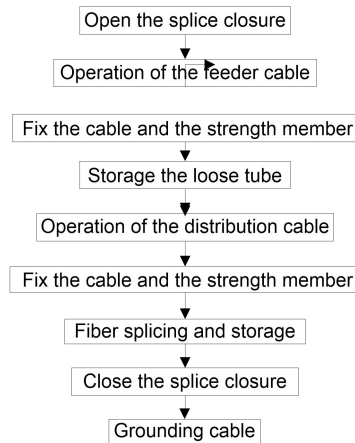

Figure 5-1

5.2 Open the splice closure

Open the hoop of the splice closure, the anti-theft screw is selected.



Figure 5-2

- a. Pull the block out;
- b. Use the buckle to hold the limit and turn the lock block;
- c. Open the buckle and unlock the hoop.

5.3 Procedure of cable stripping

The cable stripping is as the following procedure:

- ◆ Mark the stripping point on the cable according to the different length requirement. Strip the cable external layer and fiber loose tube with special tool.
- ◆ Strip the distribution cable, the requirement is as follows:
 - 1) The cable stripping length is no less than 1200mm;
 - 2) Strip the fiber loose tube at the point of 15mm from stripping point;
 - 3) Cut the central strength member at the point of 50mm from stripping point.

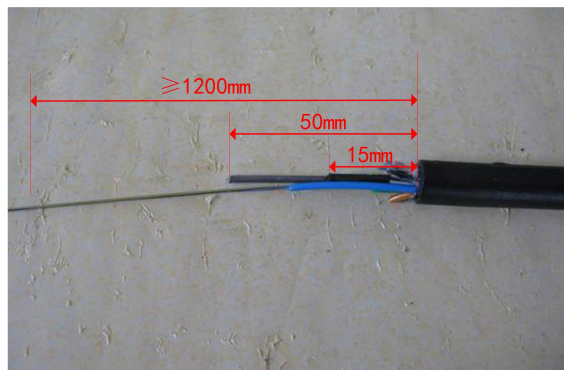

Figure 5-3

- ◆ Strip the uncut cable, the requirement is as follows:
 - 1) The cable stripping length is no less than 1200mm;
 - 2) Cut the central strength member at the point of 50mm from two stripping points.

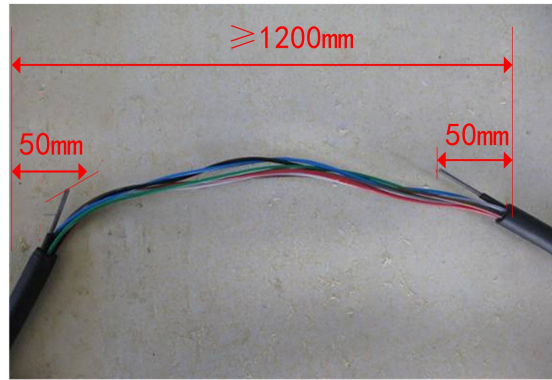

Figure 5-4

5.4 Install the feeder cable

Open the feeder cable entrances.

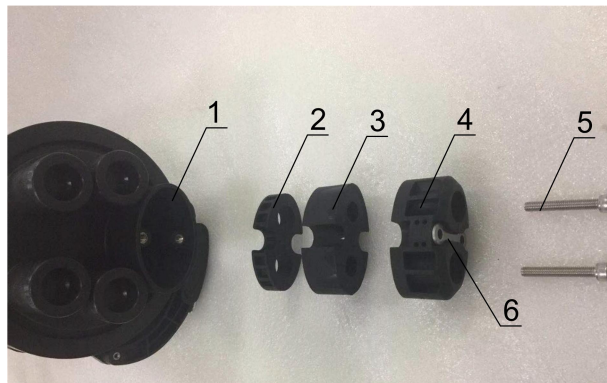

Figure 5-5

List of components for direct connection entrances.

No.	Descriptions	Qty	Application
1	Base of splice closure	1unit	Fix the inside and outside components
2	Disassembled sealing ring baffle block	1unit	
3	Double holes sealing ring	1pcs	
4	Disassembled pressing block	2pcs	
5	Hexagon screw	2pcs	
6	Flat washer	1pcs	

Installing procedure of feeder cable entrance:

- 1) Knock down the marking structure in the drawing before entering the cable.

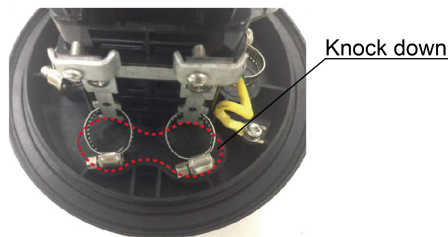

Figure 5-6

- 2) Pass the mid-span cable into the mid-span cable port.



Figure 5-7

- 3) Secure the cable with hose clamp, secure the strength member with screw.

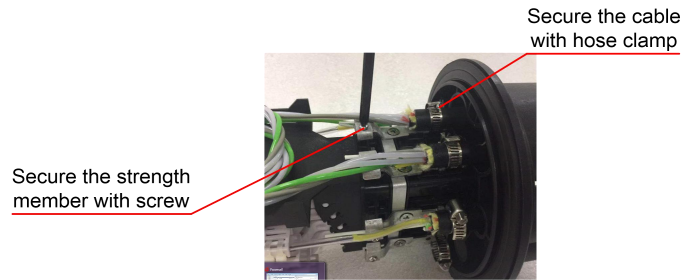

Figure 5-8

Feeder cable sealing:

- 1) Cut the both sides of the double holes seal ring with a knife.

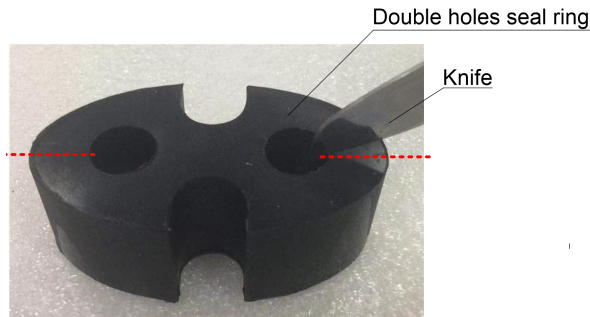

Figure 5-9

- 2) Install the sealing assembly on the mid-span cable in order, then install them into the mid-span cable port.

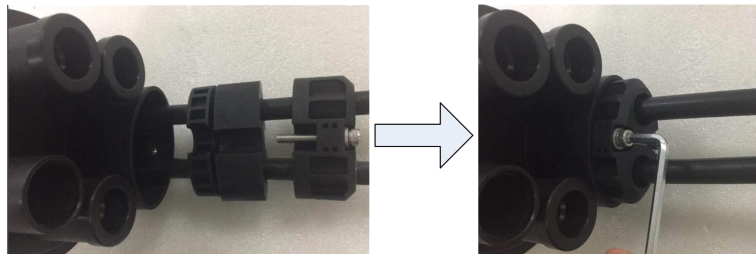

Figure 5-10

5.5 Operation of the distribution cable

Installing procedure of distribution cable entrance:

- 1) Knock down the sealing structure before entering the cable same as feeder cable entrance.
- 2) View of components for distribution cable entrance, then put the distribution cable into the entrance.

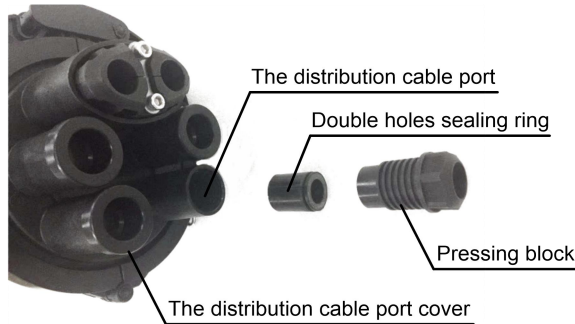

Figure 5-11

- 3) Lock the distribution cable with hoop and fix the central strength member.

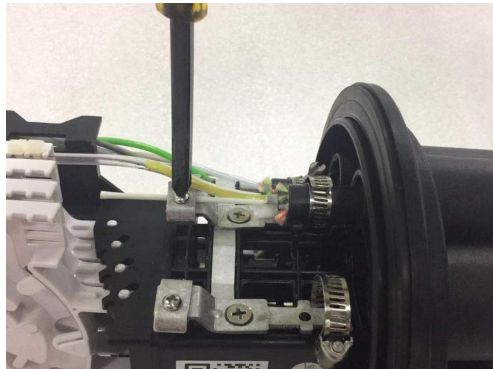

Figure 5-12

- 4) Install the sealing assembly on the distribution cable in order, then install them into the distribution cable port.

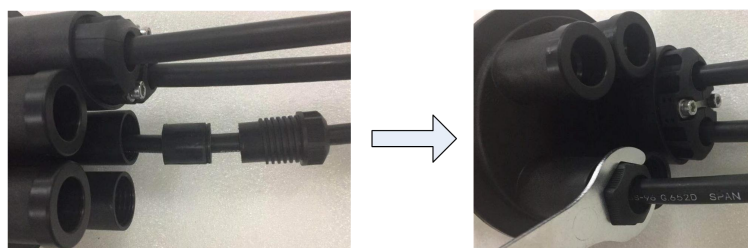

Figure 5-13

5.6 Fiber splicing and storage

The procedure of fiber splicing is as follows:

- 1) Store the fiber of the uncut main cable at the back of the bracket.



Figure 5-14

- 2) Strip the cut main cable, access it into the splicing tray with bare fiber protective tube.

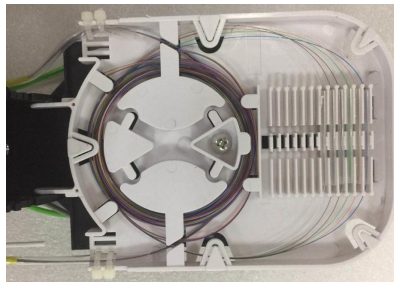

Figure 5-15

- 3) Splice the fibers of the main cable and distribution cable in the splice tray directly, fix the tray with the plastic cover while overturning the tray.
- 4) If necessary, the splitter can be mounted in the tray with the special slot.

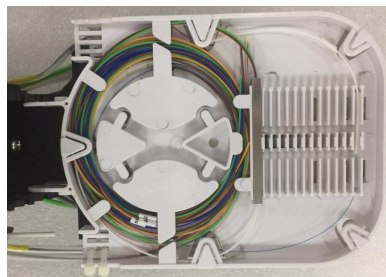

Figure 5-16

6 Installation of the splice closure

6.1 Wall-mounting

Hammer the plastic expansion sleeve completely into the drilled holes, fit the mounting bracket on the Wall with screw.

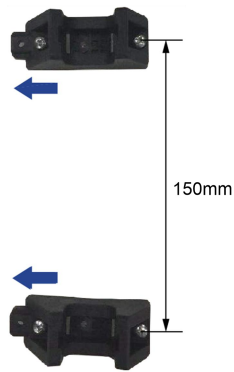

Figure 6-1

Fix the dome on the mounting bracket with screw.

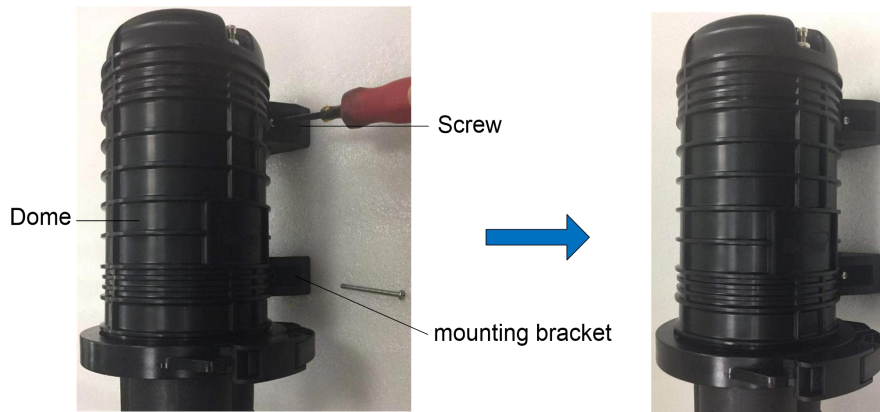

Figure 6-2

6.2 Pole-mounting

Put the hoop into the mounting bracket.

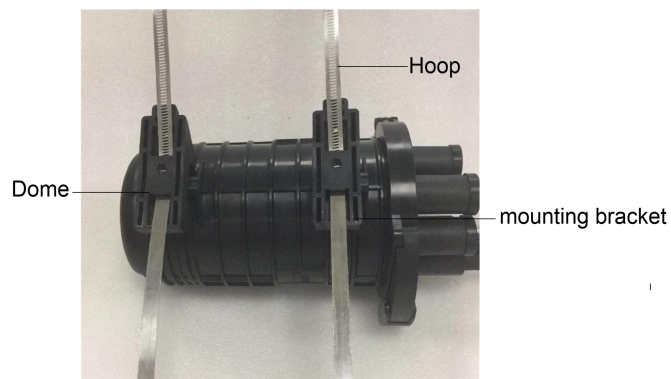

Figure 6-3

Fit the dome to the pole with the hoop.



Figure 6-4

6.3 Cable messenger-mounted

Install the clasps onto the 2 mounting holes at the back of the box.

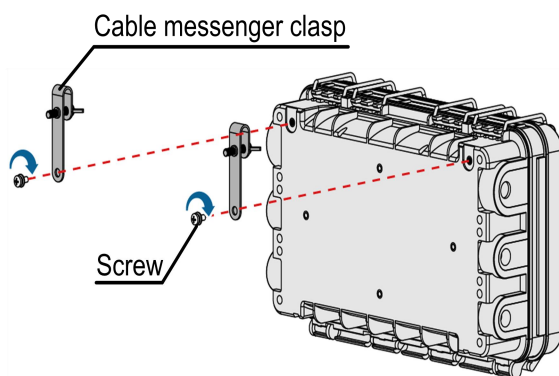

Figure 6-5

Hang the box onto the cable messenger and then secure it with the screws.

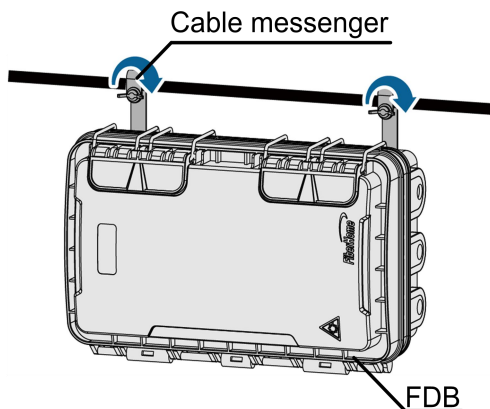

Figure 6-6