

Pocket2 Pocket Thermography Camera



HIKMICRO Pocket Series is equipped with a high-resolution HIKMICRO VOx detector, an 8 MP optical camera, and a 3.5" LCD touch screen. It helps you quickly and efficiently locate the hidden problems and accurately measure abnormal temperature. The wide temperature range of -20°C to 400°C is ideal for building inspection, HVAC, electrical, and mechanical equipment maintenance. The 25 Hz frame rate keeps up with fast inspections, and the Wi-Fi function allows the Pocket to share images in real time. The Pocket Series is a powerful thermography tool in your pocket, so it is always there whenever you need it.

Key Feature

- Thermal resolution: 256 × 192 (49,152 pixels), NETD: < 40 mK (@ 25°C, F# = 1.0)
- Accurately measure temperature from -20°C to 400°C (-4°F to 752°F)
- Accuracy: Max. ($\pm 2^{\circ}\text{C}/3.6^{\circ}\text{F}$, $\pm 2\%$)
- 25 Hz image frequency
- Thermal, Fusion, PIP, Visual, and Blending modes
- Manual, automatic, and 1-Tap level and span
- High temperature alarm
- Built-in 16 GB memory
- LED work light
- 1.0x to 4.0x continuous digital zoom
- 8 MP visual camera
- Up to 4 hours continuous running

▪ Specification

Infrared Image	
IR Resolution	256 × 192 (49, 152 pixels)
NETD	< 40 mK (@ 25°C, F#=1.0)
Image Frequency	25 Hz
Detector Pitch	12 μm
Spectral Range	7.5 to 14 μm
Focal Length	3.5 mm
F-number	F1.1
Field of View (FOV)	50° × 37.2°
Spatial Resolution (IFOV)	3.43 mrad
Min. Focus Distance	0.3 m (0.98 ft)
Focus Mode	Focus Free
Image Display	
Visual Camera	3264 × 2448 (8 MP)
Display	640 × 480 Resolution, 3.5" LCD Touch Screen with auto-rotation
Screen Brightness	Manual
Digital Zoom	1.0x to 4.0x continuous
Color Palettes	White Hot, Black Hot, Rainbow, Ironbow, Red Hot, Fusion, Rain, Blue Red
Image Modes	Thermal/Visual/Fusion/PIP/Blending
Measurement and Analysis	
Object Temperature Range	-20°C to 400°C (-4°F to 752°F)
Accuracy	Max. (±2°C/3.6°F, ±2%), for the ambient temp. 15°C to 35°C (59°F to 95°F) and object temp. above 0°C (32°F)
Measurement Tools	Center Spot, Hot Spot, Cold Spot
Level and Span Mode	Auto/Manual/1-Tap Touch-screen
Data Storage and Communication	
Storage Media	Built-in 16 GB flash memory
Image Storage Capacity	Approx. 60,000 Images
Annotations	Text note: max. 200 characters
Video Storage Capacity	Approx. 54 hours
Video File Format	MP4 video
General	
Wi-Fi	802.11 b/g/n (2.4 GHz and 5 GHz)
Bluetooth	Bluetooth 4.2
USB Interface	USB Type-C
LED Light	Yes
Battery Type	Rechargeable Li-ion battery
Battery Operating Time	Approx. 4 hours
Battery Charging Time	Approx. 2.5 hours fully charged
Protection Level	IP54
Drop Test Height	2 m (6.56 ft)
Working Temperature Range	-10°C to 50°C (-4°F to 122°F)
Storage Temperature Range	-20°C to 60°C (-4°F to 140°F)
Relative Humidity	< 95% non-condensing
Weight	Approx. 218 g (0.481 lb)

Dimension	138.5 mm × 85.2 mm × 23.6 mm (5.45" × 3.35" × 0.93")
Tripod Mounting	UNC ¼"-20

▪ **Available Model**

Pocket2

▪ **Dimension**

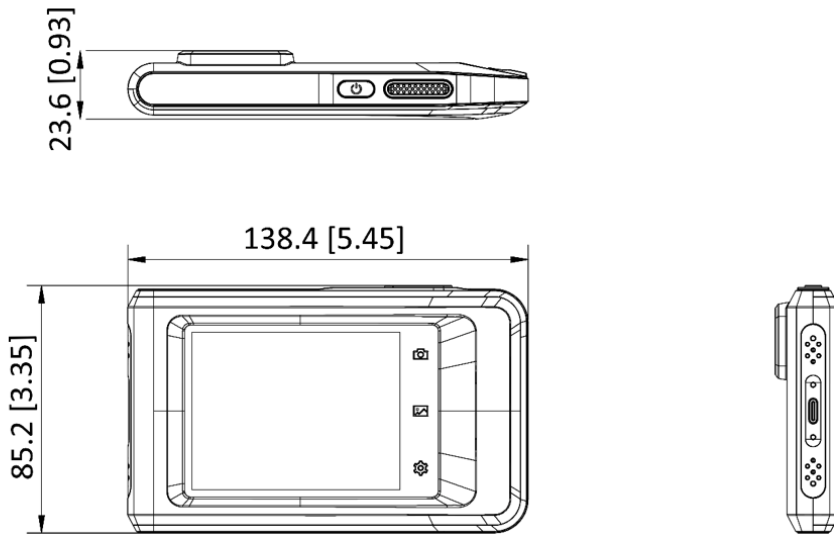

Unit: mm [inch]

▪ **Optional Accessories**



Tripod Mounting Bracket

HM-2925ZJ-TM01-BRACKET









**Thermography Camera
Macro Lens**

HM-P201-MACRO

COMPLIANCE NOTICE: The thermal series products might be subject to export controls in various countries or regions, including without limitation, the United States, European Union, United Kingdom and/or other member countries of the Wassenaar Arrangement. Please consult your professional legal or compliance expert or local government authorities for any necessary export license requirements if you intend to transfer, export, re-export the thermal series products between different countries.



 HIKMICRO Thermography  hikmicro_thermography  HIKMICRO Thermography  HIKMICRO  info@hikmicrotech.com  http://hikmicrotech.com/en

© 2023 Hangzhou HIKMICRO Sensing Technology Co., Ltd. All Rights Reserved.
Data subject to change without notice!